

Bi-directional DC power supply

IT-M3400 Series User Manual



Model: IT-M3400 Series
Version: V1.1/03,2026

Notices

© Itech Electronic, Co., Ltd. 2025

No part of this manual may be reproduced in any form or by any means (including electronic storage and retrieval or translation into a foreign language) without prior permission and written consent from Itech Electronic, Co., Ltd. as governed by international copyright laws.

Manual Part Number



402225

Trademarks

Pentium is U.S. registered trademarks of Intel Corporation.

Microsoft, Visual Studio, Windows and MS Windows are registered trademarks of Microsoft Corporation in the United States and/or other countries and regions.

Warranty

The materials contained in this document are provided “as is”, and is subject to change, without prior notice, in future editions. Further, to the maximum extent permitted by applicable laws, ITECH disclaims all warrants, either express or implied, with regard to this manual and any information contained herein, including but not limited to the implied warranties of merchantability and fitness for a particular purpose. ITECH shall not be held liable for errors or for incidental or indirect damages in connection with the furnishing, use or application of this document or of any information contained herein. Should ITECH and the user enter into a separate written agreement with warranty terms covering the materials in this document that conflict with these terms, the warranty terms in the separate agreement shall prevail.

Technology Licenses

The hardware and/or software described herein are furnished under a license and may be used or copied only in accordance with the terms of such license.

Restricted Rights Legend

Restricted permissions of the U.S. government. Permissions for software and technical data which are authorized to the U.S. Government only include those for custom provision to end users. ITECH follows FAR 12.211 (technical data), 12.212 (computer software). DFARS 252.227-7015 (technical data—commercial products) and DFARS 227.7202-3 (permissions for commercial computer software or computer software documents) while providing the customized business licenses of software and technical data.

Safety Notices

CAUTION

A CAUTION sign denotes a hazard. It calls attention to an operating procedure or practice that, if not correctly performed or adhered to, could result in damage to the product or loss of important data. Do not proceed beyond a CAUTION sign until the indicated conditions are fully understood and met.

WARNING

A WARNING sign denotes a hazard. It calls attention to an operating procedure or practice that, if not correctly performed or adhered to, could result in personal injury or death. Do not proceed beyond a WARNING sign until the indicated conditions are fully understood and met.



Note

A NOTE sign denotes important hint. It calls attention to tips or supplementary information that is essential for users to refer to.

Quality Certification and Assurance

We certify that series instrument meets all the published specifications at time of shipment from the factory.

Warranty

ITECH warrants that the product will be free from defects in material and workmanship under normal use for a period of one (1) year from the date of delivery (except those described in the Limitation of Warranty below).



Note

Visit <https://www.itechate.com/en/support/register.html> to complete product registration by filling out the necessary information to extend the warranty to two (2) years.

For warranty service or repair, the product must be returned to a service center designated by ITECH.















- The product returned to ITECH for warranty service must be shipped PRE-PAID. And ITECH will pay for return of the product to customer.
- If the product is returned to ITECH for warranty service from overseas, all the freights, duties and other taxes shall be on the account of customer.

Limitation of Warranty

This Warranty will be rendered invalid in case of the following:

- Damage caused by circuit installed by customer or using customer own products or accessories;
- Modified or repaired by customer without authorization;
- Damage caused by circuit installed by customer or not operating our products under designated environment;
- The product model or serial number is altered, deleted, removed or made illegible by customer;
- Damaged as a result of accidents, including but not limited to lightning, moisture, fire, improper use or negligence.

Safety Symbols

	Direct current		ON (power)
	Alternating current		OFF (power)
	Both direct and alternating current		Power-on state
	Chassis (earth ground) symbol.		Power-off state
	Earth (ground) terminal		Reference terminal
	Caution		Positive terminal
	Warning (refer to this manual for specific Warning or Caution information)		Negative terminal
	A chassis terminal	-	-

Safety Precautions

The following safety precautions must be observed during all phases of operation of this instrument. Failure to comply with these precautions or specific warnings elsewhere in this manual will constitute a default under safety standards of design, manufacture and intended use of the instrument. ITECH assumes no liability for the customer's failure to comply with these precautions.

WARNING

- Do not use the instrument if it is damaged. Before operation, check the casing to see whether it cracks. Do not operate the instrument in the presence of inflammable gasses, vapors or dusts.
 - The instrument is provided with a power cord during delivery and should be connected to a socket with a protective earth terminal, a junction box or a three-phase distribution box. Before operation, be sure that the instrument is well grounded.
 - Please always use the provided cable to connect the instrument.
 - Check all marks on the instrument before connecting the instrument to power supply.
 - Ensure the voltage fluctuation of mains supply is less than 10% of the working voltage range in order to reduce risks of fire and electric shock.
 - Do not install alternative parts on the instrument or perform any unauthorized modification.
 - Do not use the instrument if the detachable cover is removed or loosen.
 - To prevent the possibility of accidental injuries, be sure to use the power adapter supplied by the manufacturer only.
 - We do not accept responsibility for any direct or indirect financial damage or loss of profit that might occur when using the instrument.
 - This instrument is used for industrial purposes, do not apply this product to IT power supply system.
 - Never use the instrument with a life-support system or any other equipment subject to safety requirements.
-

WARNING

- **SHOCK HAZARD Ground the Instrument.** This product is provided with a protective earth terminal. To minimize shock hazard, the instrument must be connected to the AC mains through a grounded power cable, with the ground wire firmly connected to an electrical ground (safety ground) at the power outlet or distribution box. Any interruption of the protective (grounding) conductor or disconnection of the protective earth terminal will cause a potential shock hazard that could result in injury or death.
- **Before applying power, verify that all safety precautions are taken.** All connections must be made with the instrument turned off, and must be performed by qualified personnel who are aware of the hazards involved. Improper actions can cause fatal injury as well as equipment damage.
- **SHOCK HAZARD, LETHAL VOLTAGES** This product can output input the dangerous voltage that can cause personal injury, and the operator must always be protected from electric shock. Ensure that the output input electrodes are either insulated or covered using the safety covers provided, so that no accidental contact with lethal voltages can occur.
- **Never touch cables or connections immediately after turning off the instrument.** Verify that there is no dangerous voltage on the electrodes or sense terminals before touching them.
- **After using the device, turn off the power switch of the device before unplugging the power cord or disassembling the terminals.** Do not touch the cable or the terminal immediately. Depending on the model, the dangerous voltage at the plug or terminal is maintained for 10 seconds after the device is switched off. Make sure that there is no dangerous voltage before touching them.

CAUTION

- **Failure to use the instrument as directed by the manufacturer may render its protective features void.**
- **Always clean the casing with a dry cloth. Do not clean the internals.**
- **Make sure the vent hole is always unblocked.**

Environmental Conditions





The instrument is designed for indoor use and an area with low condensation. The table below shows the general environmental requirements for the instrument.

Environmental Conditions	Requirements
Operating temperature	0°C ~ 40°C
Operating humidity	20% ~ 80%(non-condensation)
Storage temperature	-20°C ~ 70°C
Altitude	Operating up to 2,000 meters
Installation category	II
Pollution degree	Pollution degree 2



Note

In order to ensure the accuracy of measurement, it is recommended to operate the instrument half an hour after start-up.

Regulation Tag

	The CE tag shows that the product complies with the provisions of all relevant European laws (if the year is shown, it indicates that the year when the design is approved).
	The UKCA tag shows that the product complies with the provisions of all relevant United Kingdom laws (if the year is shown, it indicates that the year when the design is approved).
	This instrument complies with the WEEE directive (2002/96/EC) tag requirements. This attached product tag shows that the electrical/electronic product cannot be discarded in household waste.
	This symbol indicates that no danger will happen or toxic substances will not leak or cause damage in normal use within the specified period. The service life of the product is 10 years. The product can be used safely within the environmental protection period; otherwise, the product should be put into the recycling system.

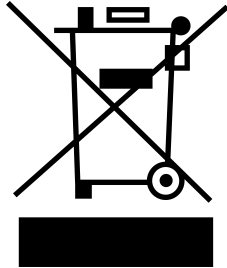
Waste Electrical and Electronic Equipment (WEEE) Directive



Waste electrical and electronic equipment (WEEE) directive, 2002/96/EC

The product complies with tag requirements of the WEEE directive (2002/96/EC). This tag indicates that the electronic equipment cannot be disposed of as ordinary household waste. Product Category

According to the equipment classification in Annex I of the WEEE directive, this instrument belongs to the "Monitoring" product.

If you want to return the unnecessary instrument, please contact the nearest sales office of ITECH.



Compliance Information

Complies with the essential requirements of the following applicable European Directives, and carries the CE marking accordingly:

- Electromagnetic Compatibility (EMC) Directive 2014/30/EU
- Low-Voltage Directive (Safety) 2014/35/EU

Conforms with the following product standards:

EMC Standard

IEC 61326-1 / EN 61326-1 ¹²³

Reference Standards

CISPR 11, Class A

IEC 61000-3-2

IEC 61000-3-3

IEC 61000-4-2

IEC 61000-4-3

IEC 61000-4-4

IEC 61000-4-5

IEC 61000-4-6

IEC 61000-4-11

1. The product is intended for use in non-residential/non-domestic environments. Use of the product in residential/domestic environments may cause electromagnetic interference.
2. Connection of the instrument to a test object may produce radiations beyond the specified limit.
3. Use high-performance shielded interface cable to ensure conformity with the EMC standards listed above.

Safety Standard

IEC 61010-1:2010+A1:2016



Note

This section provides general and universal terms. For more detailed information on the *Declaration of Conformity*, please contact ITECH personnel.

Content

Quality Certification and Assurance	I
Warranty	I
Limitation of Warranty	I
Safety Symbols	II
Safety Precautions	II
Environmental Conditions	IV
Regulation Tag	V
Waste Electrical and Electronic Equipment (WEEE) Directive	VI
	
Compliance Information	VII
1 Quick Reference	1
1.1 Brief Introduction	1
1.2 Front-Panel Overview	2
1.3 Keyboard Introduction	3
1.4 Rear Panel Introduction	5
1.5 Home-Screen Overview	6
1.6 Configuration Menu Reference	7
1.7 System Menu Reference	8
1.8 Models and Options	12
2 Inspection and Installation	16
2.1 Verifying the Shipment	16
2.2 Instrument Size Introduction	17
2.3 Rack Mounting	17
2.4 Connecting the Power Cord	18
2.5 Connecting the Device Under Test (DUT)	20
2.6 Connect the Communication Interface	24
2.6.1 USB Interface	25
2.6.2 GPIB Interface	26
2.6.3 LAN Interface	27
2.6.4 RS-232 Interface	32
2.6.5 RS-485 Interface	34
2.6.6 CAN Interface	35
3 Getting Started	38
3.1 Power-on the Instrument	38
3.2 Set output parameters	40
3.3 Use the Front Panel Menu	41
3.4 Output On/Off Control	42
4 Output Function	43
4.1 Set the Output Priority Mode	43
4.2 Set the Output Voltage	45
4.3 Set the Output Current	46
4.4 Set the Output Power	46
4.5 Set Output Slope	46
4.6 Enable the Output	47
4.7 Set the Internal Resistance	47
4.8 CR Function in Sink Mode	47
4.9 Set the Output-On/Output-Off Delay	48
5 Advanced Function	49
5.1 List function	49
5.2 Battery Charging/Discharging Test Function	54
5.3 Battery emulation function	57
6 Protect Function	62
6.1 Protect Function Setting	62

6.2	Set Over-Voltage Protection	63
6.3	Set Over-Current Protection	64
6.4	Set Over-Power Protection	65
6.5	Set Under-Current Protection	66
6.6	Set Under-Voltage Protection	68
6.7	UUT Over-Temperature Protection	69
6.8	Sense abnormal protection function	70
6.9	Over-Temperature Protection	70
6.10	Set foldback protection	71
7	System-Related Functions	73
7.1	Key Lock Function	73
7.2	Save and Recall Operations	73
7.3	Local/Remote Mode Switch	75
7.4	Basic Operation	75
7.4.1	Set the Beeper Status	75
7.4.2	Set the Power-on State	76
7.4.3	Set the Sense Function State	76
7.4.4	Set the Communication Information	76
7.4.5	Select Trigger Source	77
7.4.6	Restore the Factory Default Settings	77
7.4.7	Observe the DUT Temperature and Total Historical Regenerative Power	79
7.4.8	View the System Information	80
7.5	Measuring the DUT Temperature	80
7.6	Observe the Regenerative power and Capacity	81
7.7	External analog function (optional)	82
7.8	Anti-reverse connection module function (optional)	89
8	Multi-Machine Operation	92
8.1	Multi-Channel Function	93
8.2	Synchronized Function (Link)	95
9	Parallel Function (Parallel)	98
10	Routine Maintenance	102
10.1	Instrument Self-Test	102
10.2	Cleaning and Maintenance	102
10.3	Information Reference	103
10.4	Contact of ITECH Engineers	104
10.5	Return for Repair	105
11	Technical Specification	107
11.1	IT-M3412	107
11.2	IT-M3422	110
11.3	IT-M3432	112
11.4	IT-M3413	115
11.5	IT-M3423	117
11.6	IT-M3433	120
11.7	IT-M3414	122
11.8	IT-M3424	125
11.9	IT-M3434	127
11.10	IT-M3415	130
11.11	IT-M3425	132
11.12	IT-M3435	135
12	Supplemental Characteristics	138
A	Appendix	139
A.1	Specifications of Red and Black Test Cables	139

1 Quick Reference

This Chapter will introduce power-on check steps of this series to ensure normal start-up and usage under initialization status of the powerload. Besides, to facilitate usage, this part also displays the functions of front board, rear board and keyboard keys as well as display functions to a quick view of powerload appearance, structure and key usage functions before operation.

- ◆ [Brief Introduction](#)
- ◆ [Front-Panel Overview](#)
- ◆ [Keyboard Introduction](#)
- ◆ [Rear Panel Introduction](#)
- ◆ [Home-Screen Overview](#)
- ◆ [Configuration Menu Reference](#)
- ◆ [System Menu Reference](#)
- ◆ [Models and Options](#)

1.1 Brief Introduction

IT-M3400 bidirectional DC power supply integrates the features of a bidirectional power supply and a regenerative load. It keeps the advantages of high power density and modular architecture design of M series.

It can meet the customer's test requirement of different current and power level. Thanks to the independent multi-channel design, users can configure each channel according to the quantity and specifications of the DUT. At the same time, it has high-precision output and measurement, and has made a number of safety designs for testing, suitable for multiple test fields, such as power modules, intelligent industrial equipment, automotive electronics, charging and discharging tests of various small-capacity batteries.

Source features:

- Programmable voltage and current
- CC/CV priority
- Programmable rise/fall time for voltage and current
- Adjustable output impedance
- Battery charge test
- Various protection such as OCP, OVP, OPP, UVP, UCP

System features:

- Bidirectional energy flow and support battery simulation*1

- Support On/Off delay
- Automatic detection of power grid state to realize reliable grid connection
- Parallel up to 16 units*1
- Independent control of multi-channels, implement synchronization or proportional tracking
- sense abnormal protection
- Temperature measurement function, over temperature protection
- Anti-reverse protection function through optional accessories
- Power-off protection
- Five optional cards, supporting RS232, CAN, LAN, GPIB, USB_TMC, USB_VCP, RS485, analog and IO communication
- High-speed measurement, keep 10 times / s update rate even connecting 16 stand-alone units

*1: Only support sink current under cc mode after been paralleled.

1.2 Front-Panel Overview

The detailed descriptions of IT-M series front panel are shown as below.

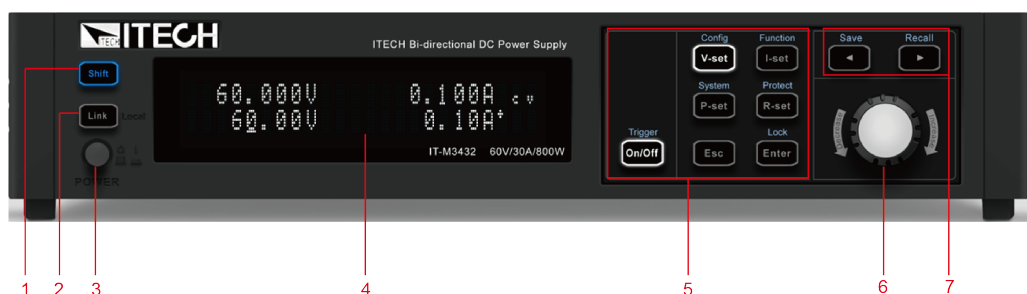



No.	Name	Description
1	[Shift] key	Composite key, combined with other keys to realize functions as marked above keys.
2	[Link] (Local) Key	<ul style="list-style-type: none"> • Turn the synchronized operation feature on or off. When lit, indicates that the instrument is in synchronous. • In remote control, press [Shift]+[Link] keys to switch the instrument to local control mode.

No.	Name	Description
3	Power On/Off switch	Turns instrument on or off.
4	Vacuum fluorescent display (VFD)	Displays all instrument functions. The information changes based on selected function.
5	Function keys group	Refer to 1.3 Keyboard Introduction for the detailed description about the function keys.
6	Push-on knob	<ul style="list-style-type: none"> Rotate the knob to adjust the setting values or scroll pages to view menu items. Rotate the knob clockwise to increase the set value and anticlockwise to decrease the set value. Pushing the knob acts like pressing [Enter] key to confirm an operation.
7	Left, and right arrow keys	<ul style="list-style-type: none"> Moves the cursor below the setting value or scrolls pages to view menu items. Save/Recall the present settings.

1.3 Keyboard Introduction

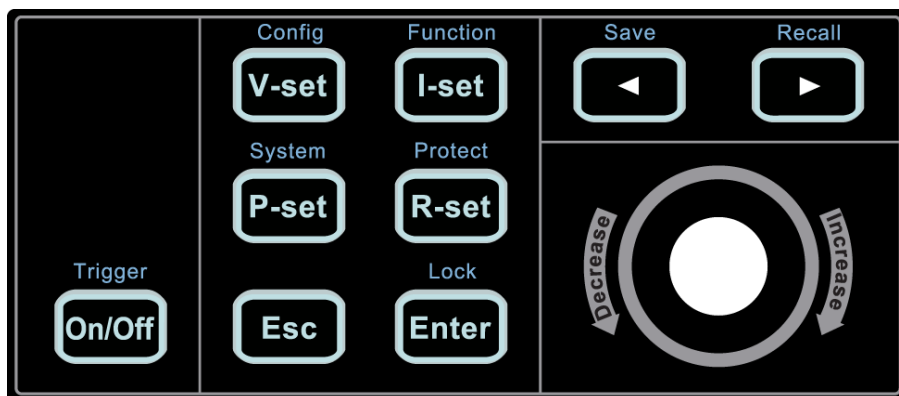

The keyboard introduction of this series power supplies is shown as follows.



Keys	Description
[V-set]	Set the voltage value In CV priority (default) mode, press [V-set] and set the output voltage value. In CC priority mode, press [V-set] and set the upper limit of voltage.
[I-set]	Set the current value In CV priority, press [I-set] and enter the current value setting state. Repress [I-set] and setting the I+ limit and I- limit. In CC priority, press [I-set] to setting the output current.
[P-set]	Set the power value
[R-set]	Set the resistance value.
[On/Off]	Power supply output on/off key
[Enter]	Operation confirmation key.
[Esc]	Press this key to cancel the present input or exit the present operation interface.
	The left navigation keys is used to adjust the cursor to the specified position or scrolls pages to view menu items. Long pressing this key and enter to save function, and key is light.
	The right navigation keys is used to adjust the cursor to the specified position or scrolls pages to view menu items. Long pressing this key and enter to recall function, and key is light.

Composite key **[Shift]**, combined with other keys to realize functions marked above keys. Firstly, press [shift] and the shift key will be lighted, and then press the function key, the detailed functions are listed as follows.

Keys	Description
[Shift]+[V-set](Config)	Enter the Config menu. Used to set the configuration parameters.
[Shift]+[I-set](Function)	Enter the Function menu. Used to set the list function, Battery test function.and battery simulation..

Keys	Description
[Shift]+[P-set](System)	Enter the system menu. Used to set the system parameters.
[Shift]+[R-set](Protect)	Enter the protection menu. Used to set the protection parameters.
[Shift]+[On/Off] (Trigger)	Generate a local trigger signal.
[Shift]+[Enter](lock)	Turn the keyboard lock on or off.
[Shift]+  (Save)	Save the common parameter settings.
[Shift]+  (Recall)	Returns the instrument to the specified setup.

1.4 Rear Panel Introduction

The detailed descriptions of the rear panel are shown as below.

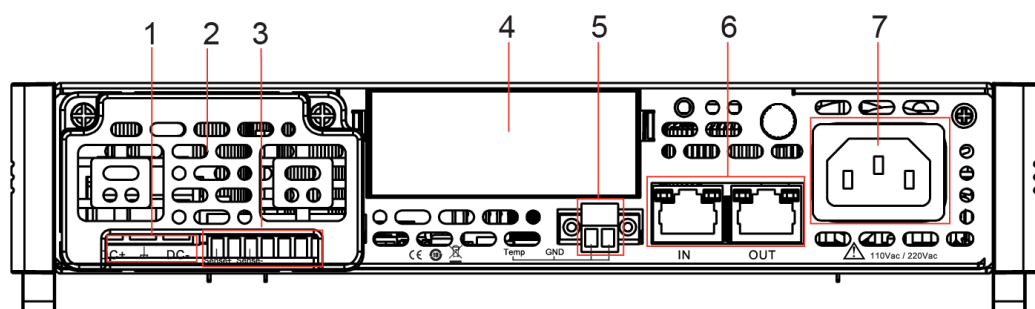

No.	Name	Description
1	DC terminals	DC+, DC- output terminals and ground terminals, used to connect DUT.
2	Protective cover	Protective cover for DC terminals and remote sense terminals. prevent user touching.
3	Remote sense terminals	used for maximizing measurement accuracy.
4	Optional expansion slot	Optional interfaces: (Plastic plugs are inserted by default when the user does not purchase the interface.) The optional interface as follows:

No.	Name	Description
		<ul style="list-style-type: none"> • USB/LAN • GPIB • RS-232/CAN • Analog interface/RS-485
5	Temperature measure terminals	Used to measure the temperature of DUT.
6	System Bus	Used for communication between instruments in parallel operation, multichannel operation and synchronized operation features.
7	AC power input terminals	Used to connect AC power to start instrument, supports 110 V or 220 V.

1.5 Home-Screen Overview

The screen information displayed as below.

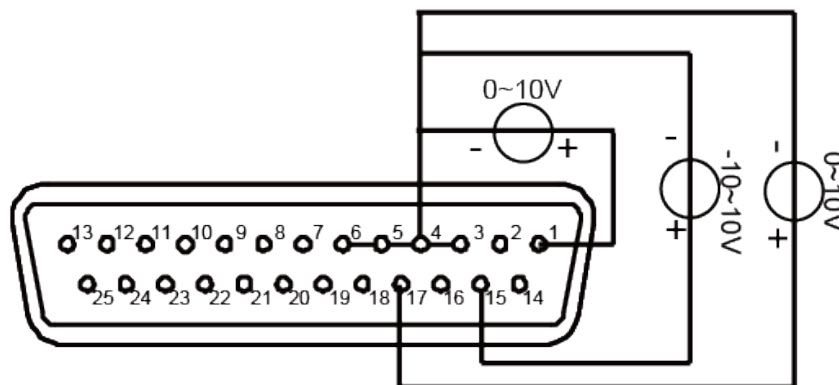

No.	Name	Description
1	Output Voltage	Displays the present output voltage value.
2	Output Current	Displays the present output current value.
3	Voltage Setting value	Displays the present voltage setting value. You can change these value by pressing the [V-set] key on the front panel.

No.	Name	Description
4	Current Setting value	Displays the present current setting value, you can change these value by pressing the [I-set] key on the front panel.
5	Output status	<ul style="list-style-type: none"> • OFF: Output is disabled. • Displays the present output status when the output is enabled.
6	The indication for current direction	Indicates present current setting value is positive current limit.

 **Note**
 The indication displays only in CV priority mode.

1.6 Configuration Menu Reference

Press **[Shift]+[V-Set]**(Config)to enter into the configuration menu interface. The instrument return to home-screen automaticly when no action in a long time.

Config	configuration of source		
	Mode	Set the output priority mode	
		CV Priority	Voltage priority mode
		CC Priority	Current priority mode
	V-Rise Time	Voltage rising time	When select CV priority, the menu shows the two items
	V-Fall Time	Voltage falling time	
	I-Rise Time	Current rising time	When select CC priority, the menu shows the two items
	I-Fall Time	Current falling time	
	Output R	Set the internal resistance.	
	On Delay	Set the output-on delay time.	
	Off Delay	Set the output-off delay time.	
	Off Voltage	Displays when select CC priority, set to zero, instrument voltage falls to 0 quicklly, set to const, instrument voltage falls to 0 as usual.	

1.7 System Menu Reference

Press **[Shift]+[P-Set]**(System) to enter into the system menu interface. At this point, the VFD screen displays the system menu items. Each menu item has a numbering identifier. The user can press Up and Down buttons or use the knob for scrolling display of other menu items. Press **[Enter]** on a menu interface to enter the setting interface. Press **[Esc]** to return to the previous menu. The instrument return to home-screen automatically when no action in a long time.

The description of the menu items is shown in the table below.

System	System menu			
	Beep	Set the beeper state.		
		Off	Turn the beeper off.	
		On	Turn the beeper on.	
	PowerOn	Set the power-on state.		
		Reset	When the instrument is powered on, the instrument will initialize some settings and [On/Off] state.	
		Last	When the instrument is powered on, the instrument will remain the same settings and [On/Off] state as last time you turned off the instrument.	
		Last+Off	When the instrument is powered on, the instrument will remain the same settings as last time you turned off the instrument, but the [On/Off] is OFF state.	
	Sense	Set the sense measurement function		
		Off	Turn the sense function off.	
		On	Turn the sense function on.	
	I/O Config	Select the interfaces communicating with PC and display dynamic information of different interface card.		
		None	No optional communication interfaces.	
		USB+LAN	When insert IT-E1206 communication board into expansion slot, the menu displays this information.	
		USB	USB communication interface.	
			TMC	USB-TMC protocol
			VCP	Virtual serial port
			LAN	LAN communication interface.
	Lan Info		View the LAN information.	
		Status	IP Mode Status	
		IP Addr	Sub Net	

					Gateway DNS1 DNS2 MAC Addr MDNS Status Host Name Host Desc Domain TCPIP INSTR Socket Port								
				Lan Config	Configure LAN information.								
					<table border="1"> <tr> <td>IP Mode</td> <td>Set IP mode.</td> </tr> <tr> <td></td> <td> Auto: automatically configure the address of the instrument. Manual: manually configure the address of the instrument by entering values in the following five fields. The following information only appear when Manual is selected. IP Addr Sub Net Gateway DNS1 DNS2 </td> </tr> <tr> <td>Server Config</td> <td>Configure the LAN services.</td> </tr> <tr> <td></td> <td>Raw Socket Port: RAWSocket port.</td> </tr> </table>	IP Mode	Set IP mode.		Auto: automatically configure the address of the instrument. Manual: manually configure the address of the instrument by entering values in the following five fields. The following information only appear when Manual is selected. IP Addr Sub Net Gateway DNS1 DNS2	Server Config	Configure the LAN services.		Raw Socket Port: RAWSocket port.
IP Mode	Set IP mode.												
	Auto: automatically configure the address of the instrument. Manual: manually configure the address of the instrument by entering values in the following five fields. The following information only appear when Manual is selected. IP Addr Sub Net Gateway DNS1 DNS2												
Server Config	Configure the LAN services.												
	Raw Socket Port: RAWSocket port.												
				Lan Restore	Select whether to reset the LAN to the default settings or not.								
					No Yes								
				Lan Save	Select whether to save the LAN setting or not.								
					No Yes								
		RS232 +CAN	When insert IT-E1207 communication board into expansion slot, the menu displays this information.										
			RS232	RS232 communication interface.									
				Display as the following format: baud rate_data bit_parity bit_stop bit. <ul style="list-style-type: none"> Select the baud rate from the following options: 4800, 9600, 19200, 38400, 57600, 115200 									

			<ul style="list-style-type: none"> The data bit, parity bit and stop bit are fixed: 8_None_1
		CAN	CAN communication interface.
			Select the baud rate from the following options: 20k, 40k, 50k, 80k, 100k, 125k, 150k, 200k, 250k, 400k, 500k, 1000k.
			Address: Set the instrument address to a number from 1 to 127.
	RS485 +Ext	When insert IT-E1208 communication board into expansion slot, the menu displays this information.	
		Analog	Set external analog interface state.
		RS485	RS485 communication interface.
			Display as the following format: baud rate_data bit_parity bit_stop bit. <ul style="list-style-type: none"> Select the baud rate from the following options: 4800, 9600, 19200, 38400, 57600. The data bit, parity bit and stop bit are fixed: 8_None_1. RS485 Addr: Set the instrument address to a number from 1 to 127.
	GPIB	When insert IT-E1205 communication board into expansion slot, the menu displays this information.	
		Address: Set the instrument address to a number from 0 to 30.	
	USB	When insert IT-E1209 communication board into expansion slot, the menu displays this information.	
	Parallel	Set the instruments to parallel operation mode.	
		Single	Set the instrument to single mode.
		Slave	Set the instrument to slave mode.
			Slave group Set the master group number which slave belongs to.
		Master	Set the instrument to master mode.
			Master group Specify the master group, the range from A to P.
			Master Total Set the total instrument number of the same group within the range from 1 to 4. When set to 1, the instrument mode is single mode.
	Link	Set the instruments to synchronized operation mode.	
		Status	Set the synchronized state. Same function as the [-Link] key.
		Offline	Disable the Link function.

	Online	Enable the Link function.
	Mode	Set the synchronized mode among multiple units.
	On/Off Only	Set multiple units to output on/off and Save/Recall synchronization.
	Track	Set multiple units to output on/off, Save/Recall synchronization and voltage proportional changing.
	Reference	Set the voltage proportional relationship among multiple units.
	Duplicate	Set multiple units to output on/off synchronization, voltage/current setting value changing synchronization, Save/Recall synchronization, priority mode synchronization, voltage/current rising/falling synchronization and Protect menu function synchronization.
Channel Number	Set the channel number. Channel Number=1(1-16), the corresponding channel number is displayed in the left of the main interface during multi-machine operation.	
Trig Source	Set the trigger source.	
	Keypad	Keypad trigger, press [Shift]+[On/Off] (Trigger) can generate a trigger signal.
	Bus	Remote interface trigger command, like *TRG
Ext-Meter Disp	Set to the UUT temperature and total regenerative electric energy are displayed on home screen.	
	On	display on home screen.
	Off	do not display on home screen.
External Meter	observe the total historical regenerative power and capacity information.	
	UUT Temp	DUT temperature
	Re-Energy	The regenerative power
	AHour	capacity of charge and discharge, when the battery simulator function or battery test function is enabled, the capacity data will be cleared.
	WHour	energy data, when the battery simulator function or battery test function is enabled, the energy data will be cleared.
	Reset Meas	clearing the energy data and capacity data.
	Reset ReE	clearing the regenerative power data.
SDS Config	Anti-reverse connection module configuration	

	None	No SDS Module detected
	Enable	Enable the SDS function
	Disable	Disable the SDS function
System Reset	Select whether to restore the factory default settings or not.	
System Info	View the system information.	
	Model	Display the instrument model.
	Ver	Display the control board version.
	CommVer	Display the communication board version.
	SN	Display the serial number.
	Last Cal	Display last calibration date.
	Start Time	Display the instrument running time.
Instr Alias	The alias of the instrument, which can be modified by the user to note information	

1.8 Models and Options

This series models include:

Model	Voltage(V)	Current(A)	Power(W)
IT-M3412	60V	30	200
IT-M3422		30	400
IT-M3432		30	800
IT-M3413	150V	12	200
IT-M3423		12	400
IT-M3433		12	800
IT-M3414	300V	6	200
IT-M3424		6	400
IT-M3434		6	800
IT-M3415	600V	3	200
IT-M3425		3	400
IT-M3435		3	800

Optional accessories:

You can purchase accessories for the IT-M series of instruments separately, including the following:

- **Scalable interface**

The interface expansion slot provided on the rear panel of the IT-M series instrument allows users to flexibly expand according to their needs. Different interface cards can be selected to achieve different functions. Includes communication interface or external analog interface.

- **Cabinet installation**

The IT-M series instruments can be mounted on a standard 19-inch cabinet. ITECH has prepared a special bracket for the user as a mounting kit.

- **Anti-reverse connection module**

The IT-M series instruments support the IT-E118 anti-reverse connection module to realize DC reverse connection protection, surge suppress, and sense reverse connection protection.

The detailed descriptions of the options are as follows.



Note

The following optional accessories from ITECH are sold separately. Users need to purchase separately.

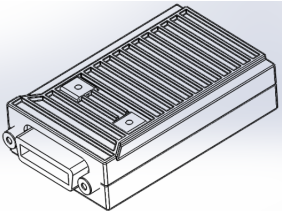
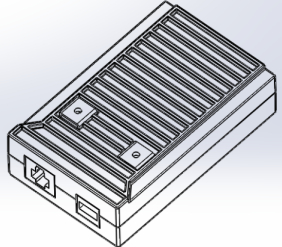
Device Name	Model	Description	Type
GPIB communication interface 	IT-E1205	When the user needs to use GPIB interface to enable remote operation, this option is the right choice.	Optional
USB/LAN communication interface 	IT-E1206	When the user needs to use USB or LAN interface to enable remote operation, this option is the right choice.	Optional

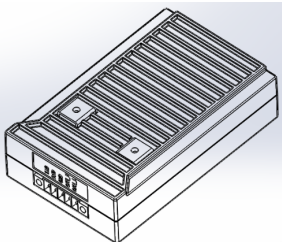
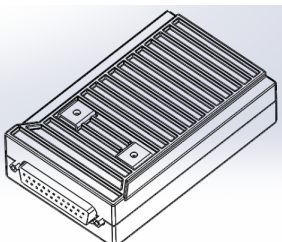
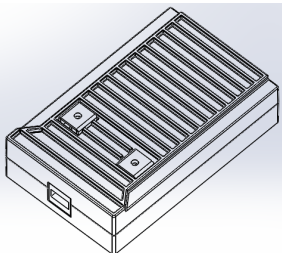
Device Name	Model	Description	Type
RS-232/CAN communication interface 	IT-E1207	When the user needs to use RS-232 or CAN interface to enable remote operation, this option is the right choice.	Optional
External analog / RS485 communication interface 	IT-E1208	When the user needs to use RS-485 to enable remote operation or external analog function, this option is the right choice.	Optional
USB communication interface 	IT-E1209	When the user needs to use USB interface to enable remote operation, this option is the right choice.	Optional

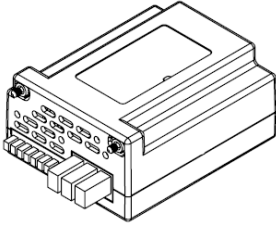
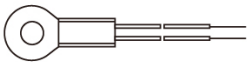
Device Name	Model	Description	Type
Anti-reverse connection module 	IT-E118	Connecting to DC and sense terminals for reverse connection protection. When the user needs to connect battery and test battery, this option is the right choice.	Optional
Cabinet installation kit	IT-E154A IT-E154B	When the instrument needs to be installed in cabinet, this kit is needed. Please refer to 《IT-E154 User Manual》 for detailed description about the installation method.	Optional
NTC thermistors for temperature measurement 	IT-E1203	When the user needs to use Temp interface to measurement DUT temperature, this option is the right choice. Wire length: 200 ±10mm	Optional

Note

After changing the communication card and analog card, you must re-start the instrument. It takes about 30 seconds for the instrument to automatically update the communication board before it is ready for use.

2 Inspection and Installation

- ◆ Verifying the Shipment
- ◆ Instrument Size Introduction
- ◆ Rack Mounting
- ◆ Connecting the Power Cord
- ◆ Connecting the Device Under Test (DUT)
- ◆ Connect the Communication Interface

2.1 Verifying the Shipment

Unpack the box and check the contents before operating the instrument. If wrong items have been delivered, if items are missing, or if there is a defect with the appearance of the items, contact the dealer from which you purchased the instrument immediately.

Table 2–1 Package box contents

Item	Qty.	Model	Remarks
双向可编程 直流电源	-	IT-M3400 series	This series include: 1.8 Models and Options .
Power Cord	X 1	-	User may select an appropriate power cord that matches the specifications of power socket used in the area. See the Section 2.4 Connecting the Power Cord for details.
Multiple instruments connection cables	X 1	-	When the user needs to connect the System Bus interfaces between Multiple instruments in parallel operation, multichannel operation and synchronized operation features, this option is the right choice.
Ex-Factory Test Report	X 1	-	It is the test report of the instrument before delivery.



Note

Upon verification of the shipment, keep the package and relevant contents thereof in a safe place. When returning the instrument for warranty service or repair, the specified packing requirements shall be met.

2.2 Instrument Size Introduction

The instrument should be installed at well-ventilated and rational-sized space. Please select appropriate space for installation based on the instrument size.

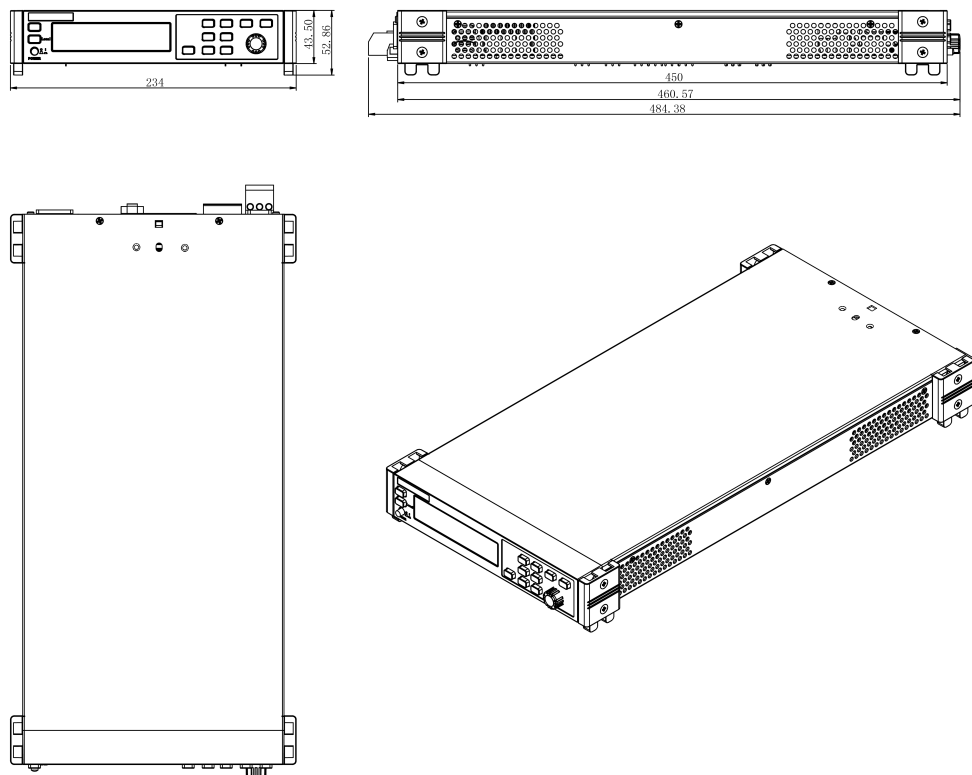
The detailed dimension drawings of the IT-M3400 series are as follows: (Unit: mm, allowable deviation value: ± 1 mm)



2.3 Rack Mounting

This instrument can be installed on standard 19-inch rack. ITECH provides user with optional mount kit. The detailed information please refer to [1.8 Models and Options](#), and the detailed operation please refer to the user manual of your purchased mount kit.

2.4 Connecting the Power Cord

Precautions

To prevent electric shock and damage to the instrument, please observe the following precautions.

WARNING

- **The power cords supplied with this product is certified for safety. In case the supplied lines assembly needs to be replaced, or an extension lines must be added, be sure that it can meet the required power ratings of this product. Any misuse voids the warranty of this product.**
 - **Before connecting power cord, be sure to confirm that the power voltage matches with the supply voltage.**
 - **Before connecting power cord, be sure to switch off the instrument. Power switch is in Off position.**
 - **To avoid fire or electric shock, make sure to use the power cord supplied by ITECH.**
 - **Do not use an extended power cord without protective grounding, otherwise the protection function will fail.**
 - **Be sure to connect the main power socket to the power outlet with protective grounding. Do not use terminal board without protective grounding.**
 - **The instrument rear panel provides a separate screw used for chassis ground. Please make proper connections. In the event of a failure, not grounding properly may result in personal injury or death due to electric shock.**
-

CAUTION

Safety agency requirements dictate that there must be a way to physically disconnect the AC mains cable from the unit. A disconnect device, either a switch or circuit breaker must be provided in the final installation. The disconnect device must be close to the equipment, be easily accessible, and be marked as the disconnect device for this equipment.

Categories of Power Cords

The standard power cord types are as follows. Please select appropriate power cords appropriate to local voltage based on the specifications of power cords below. If purchased model fails to meet local voltage requirements, please contact distributor or factory for change.

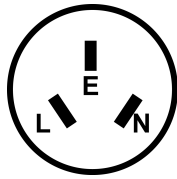

China
IT-E171

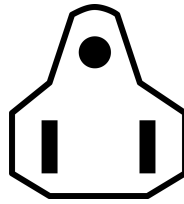

United States &
Canada & Japan
IT-E172

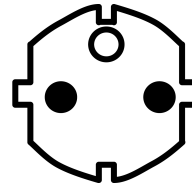

Europe
IT-E173

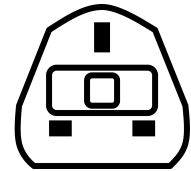

England
IT-E174

AC Power Input Level

This series power supply comes default with 100Vac-240Vac, 47Hz~63Hz universal input range.

Connecting the Power Cord

To connect the power cord:

1. Make sure that the front-panel power switch is in the OFF position.
2. Connect the female end of the supplied line cord to the AC receptacle on the rear panel.
3. Connect the plug of the power cord to a grounded AC outlet.

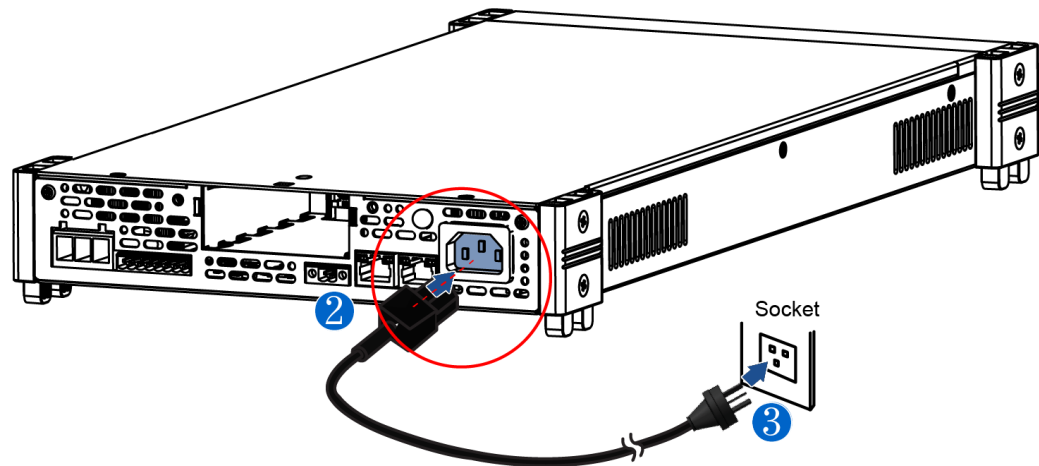

2.5 Connecting the Device Under Test (DUT)

The instrument supports two connection methods with DUT: Local measurement and Remote sensing. The default test mode is local measurement.

- Local measurement: The sense voltage is measured from the output terminals.
- Remote sensing: The sense voltage is measured from DUT terminals.

This series instrument include built-in circuit that connect or disconnect the \pm sense terminals from their corresponding \pm output terminals. As shipped, the sense terminals are internally connected to the output terminals. This is referred to as Local measurement. If you need to use remote sensing, after making the connection, be sure to turn the sense function on under system menu.

Precautions

To prevent electric shock and damage to the instrument, observe the following precautions.

WARNING

- **Before connecting test cables, be sure to switch off the power supply. Power switch is in Off position, otherwise touching the output terminals on the rear panel may result in personal injury or death due to electric shock.**
 - **To avoid electrical shock, before testing, please make sure the rating values of the testing cables, and do not measure the current that higher than the rating value. All test cables shall be capable of withstanding the maximum short circuit output current of the power supply without causing overheat.**
 - **If several loads are provided, each pair of load wires shall safely withstand the rated short circuit output current of the power supply under full load.**
 - **To avoid battery short circuit, be sure to check that the test line end is not connected when connecting or disassembling the test line. When the test line end is connected with battery, short circuit may cause severe accident.**
 - **To avoid the damage of the instrument, please make sure the positive and negative electrodes of the electrode when connecting the battery and other energy storage equipment. The reverse connection of the battery is not allowed in the instrument. When wiring, you can choose the battery anti-reverse connection module provided by ITECH.**
 - **During wiring, check that the anode and cathode of the test lines are properly and tightly connected; anode ON and cathode OFF are prohibited.**
 - **If you need to pull out the green output terminal, please lift it up and pull it out, otherwise it will damage the instrument.**
-

Specification

Test cables are not standard accessories for the instrument. Please select optional red and black test cables for individual sales based on the maximum current value. For specifications of test cables and maximum current values, refer to [A.1 Specifications of Red and Black Test Cables](#) for more information.

Connecting the DUT (Local Measurement)

The connection diagram and steps of local measurement are as follows:

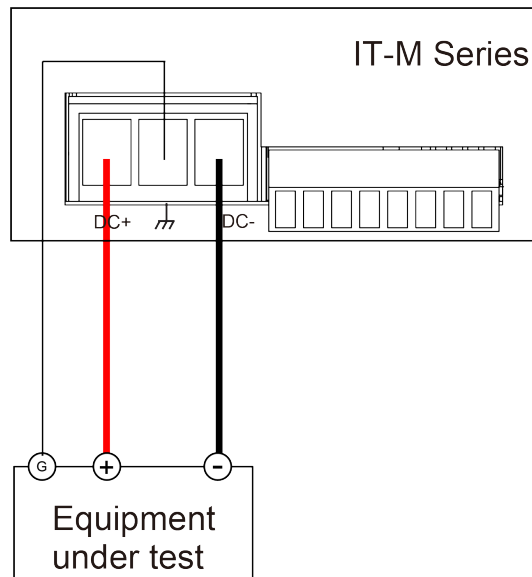

1. Confirm that the power switch is in the OFF position and verify that there is no dangerous voltage on the connection terminals.
2. Remove the output terminals cover of the DC output.
3. Loosen the screws of the output terminals and connect the red and black test cables to the output terminals, and connect the ground terminal correctly. Re-tighten the screws.
4. Thread the red and black test cables through the output terminals cover of the power system and install the cover.
5. Connect the other end of the red and black cables to the DUT. The positive and negative poles must be properly connected and fastened when wiring.

Connecting the DUT (Remote Sensing)

When the DUT consumes large current or the wires are too long, there is a voltage drop on the wires between DUT and output terminals of the power system. To maximize measurement accuracy, the power system provides the remote measurement terminals VS+ and VS- on the rear panel, which can be used to measure the terminal voltage of the DUT.

When the power system is used for battery testing in actual applications, the voltage drop of the wire will lead to voltage inconsistency of both ends and inconsistency of the cutoff voltage of power system and the actual voltage of battery, resulting in inaccurate measurement. The connection diagram and steps of remote sensing are as follows, taking the pluggable output terminals as an example.

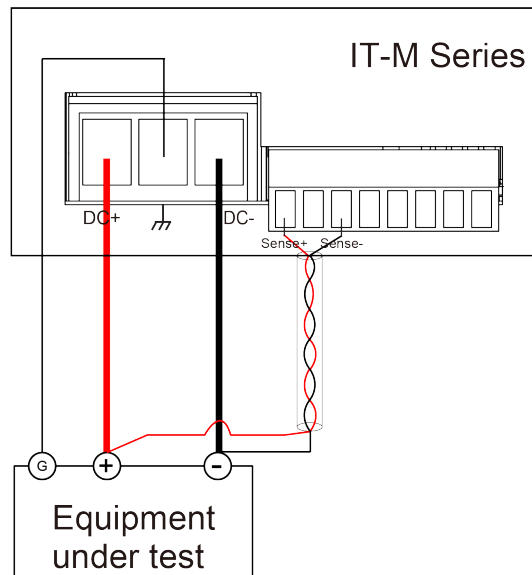

1. Confirm that the power switch is in the OFF position and verify that there is no dangerous voltage on the connection terminals.
2. Remove the output terminals cover of the DC output.
3. Loosen the screws of the output terminals and connect the red and black test cables to the output terminals, and connect the ground terminal correctly. Re-tighten the screws.
4. Refer to the wiring diagram, and use armored twisted-pair cables to connect the remote sense terminals and the equipment under test.
5. Thread the red and black test cables and sense cables through the output terminals cover and install the cover.
6. Connect the other end of the remote sense cables and the red and black cables to the DUT. The positive and negative poles must be properly connected and fastened when wiring.
7. Power on the instrument.
8. Turn the sense function on.
 - a. Press **[Shift]+[P-Set]**(System) to enter into the system menu interface.
 - b. Rotate the knob to select Sense and press **[Enter]** key to make the parameter in modification.
 - c. Rotate the knob to select **On** or **Off**, select **On** and press **[Enter]** to confirm.
 - d. Press **[Esc]**key to exit.



Note

To ensure the stability of the system, use armored twisted-pair cables between the remote sense terminals and the equipment under test. If you connect the battery and other energy storage equipment, there will be lighting or reverse connection phenomenon, reverse connection will directly damage the equipment, please choose the anti-reverse connection module, detailed introduction please refer to [7.8 Anti-reverse connection module function \(optional\)](#).

2.6 Connect the Communication Interface

The IT-M series power supply has no standard-equipped communication interfaces. User can purchase communication cards separately. User can choose one of RS-232, USB, GPIB, RS-485, LAN, CAN to communicate with the computer. For details, see [1.8 Models and Options](#).

The reserved communication card installation slot is on the rear panel of the instrument. User can install it directly after purchasing the communication card. The instrument must be power off when install or remove the communication card interface.

The installing steps for the purchased communication card are as follows:

1. Remove the plug of the rear panel interface.
 - a. Use a small flat screwdriver to press the clip at the upper cover opening.
 - b. At the same time, use another small flat screwdriver to stir the slots one by one from another opening of the upper cover, and push the plastic plug out.

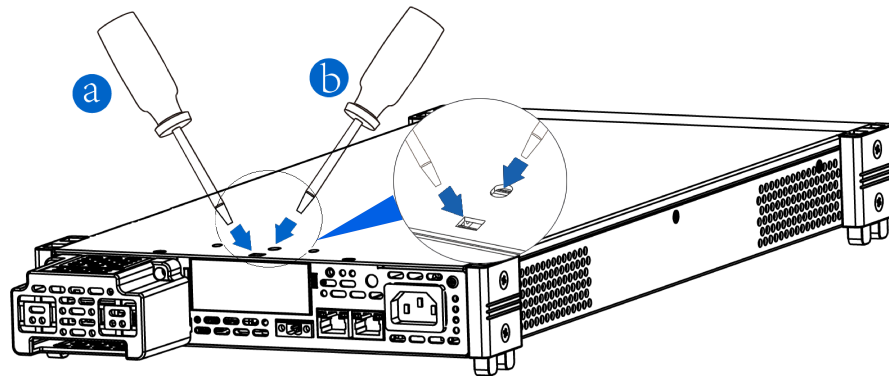

2. Install the purchased communication card. Taking the LAN+USB interface card as an example, push the card into the slot and secure with the screws

from the upper cover, it is shown as follow.

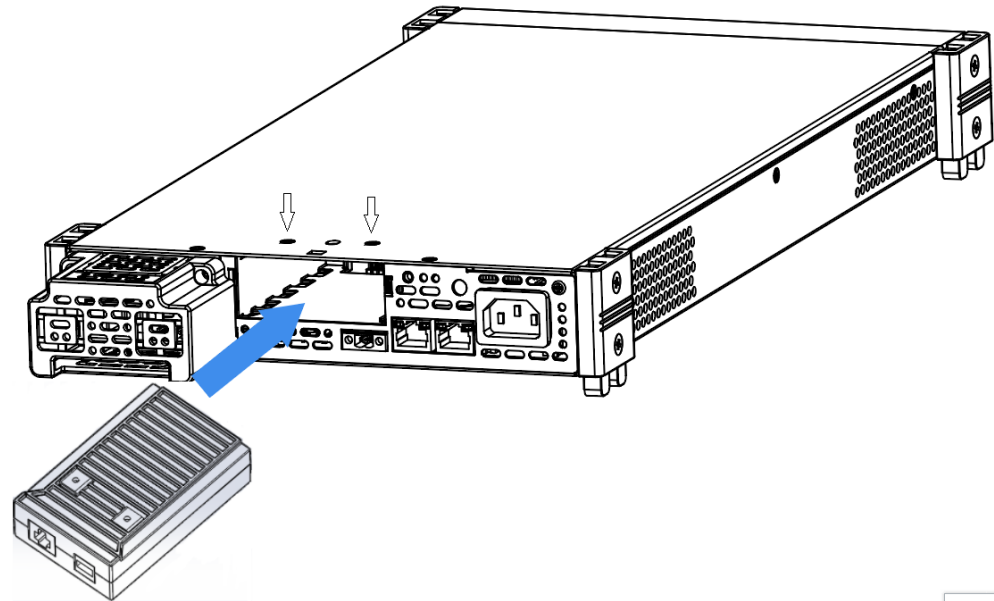

Note

Firstly loosen the screws between upper cover and communication card and removing the communication card like removing the plug, please use the tools and remove it.

2.6.1 USB Interface

When the optional interface card is a stand-alone USB interface (IT-E1209) or USB+LAN interface (IT-E1206), the following can help users quickly understand the steps required to connect the USB interface.

The figure below shows a typical USB interface system.

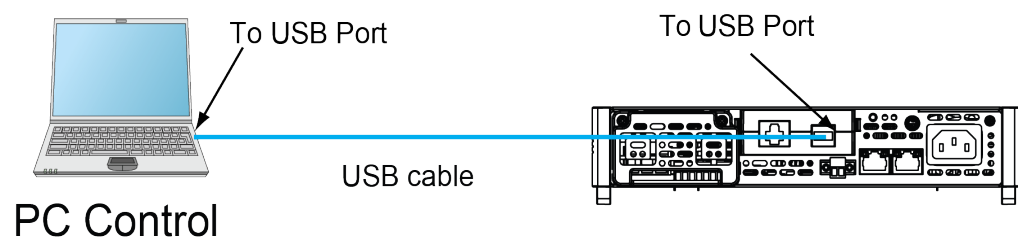

Note

Take the USB+LAN communication card box as an example. If you install USB only, please refer to the actual interface position.

1. Refer to the USB connection diagram, connect the instrument and the computer using a cable with two USB interfaces (each end).

2. Press the composite keys **[Shift]+[P-Set]**(System) to enter into the system menu interface.
3. Use left and right keys or rotate the knob to select **I/O Config** and press **[Enter]** key to confirm.
4. Use left and right keys or rotate the knob to select **USB** and press **[Enter]** key to enter the usb setting menu.
5. Use left and right keys or rotate the knob to select **TMC** or **VCP**, after select and press **[Enter]** to confirm.
 - TMC: USB_TMC interface
 - VCP: virtual serial port. Select this type, you need to install the corresponding driver (download from the ITECH website or contact ITECH agent). The device manager of PC will display 'Prolific USB-to-Serial COM Port' after installing.
6. After finishing the setting, press **[Esc]** to exit.

2.6.2 GPIB Interface

When the optional interface card is a GPIB interface (IT-E1205), you need to know the following.

Each device on the GPIB (IEEE-488) interface must have a unique number address between 0 and 30. Your computer's GPIB interface card address must not conflict with any instrument on the interface bus. This setting is nonvolatile; it will not be changed by power cycling or *RST. The figure below shows a typical GPIB interface system.

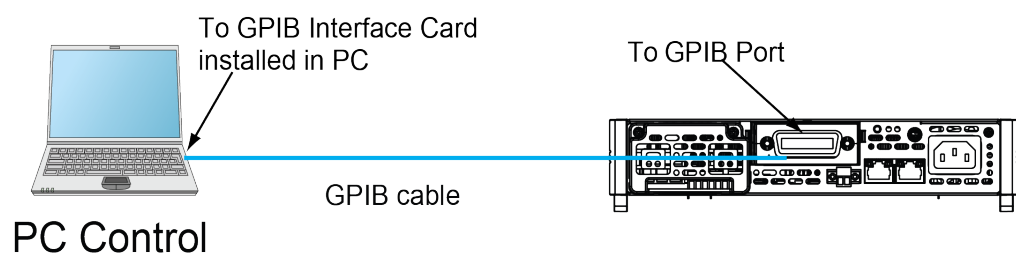

You can change the GPIB address in the system menu. The operation steps are as follows.

1. Refer to the GPIB connection diagram, Connect the power supply and the computer using a IEEE-488 bus.
2. Press **[Shift]+[P-Set]**(System) to enter into the system menu interface.
3. Use left and right keys or rotate the knob to select **I/O Config** and press **[Enter]** key to confirm.
4. Use left and right keys or rotate the knob to select GPIB and set GPIB Address, press **[Enter]** key to confirm.

5. Press **[Esc]** to exit.

2.6.3 LAN Interface

When the user's optional interface card is a LAN+USB interface (IT-E1206), the following is required to use the LAN interface. The LAN interface complies with the LXI standard.

LAN Connection

Use the following steps to quickly connect your instrument to your LAN and configure it. Two typical LAN interface systems are described below: private LAN and site LAN.

- **Connect to the private LAN**

A private LAN is a network in which LAN-enabled instruments and computers are directly connected. They are typically small, with no centrally managed resources. When connected to a computer, a crossover cable can be used to connect directly to the computer via the LAN interface.

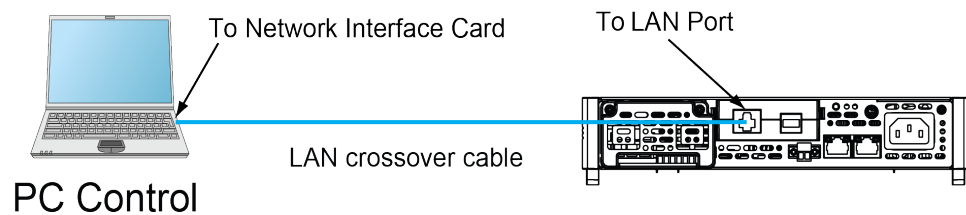

- **Connect to the site LAN**

A site LAN is a local area network in which LAN-enabled instruments and computers are connected to the network through routers, hubs, and/or switches. They are typically large, centrally-managed networks with services such as DHCP and DNS servers. When connected to a computer, a direct attached network cable can be used to connect to the router, and the computer is also connected to the router.

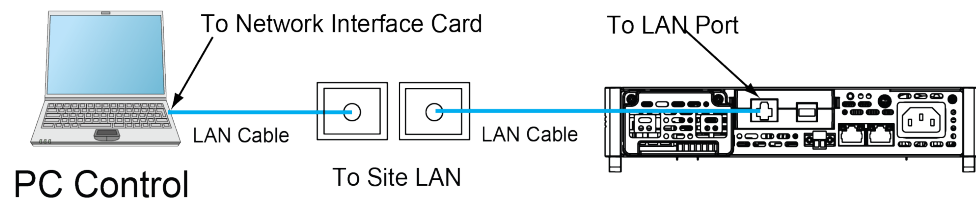

Note

- When using one crossover cable to connect PC directly, the gateway address of the instrument should be consistent with that of the PC, and the IP address should be at the same network segment with the PC's IP address.
- When the instrument and computer are connected to the router, an independent IP address must be assigned for the instrument.

LAN Status Indicator

The lower icon notes the two status LEDs located at the bottom of the LAN port.

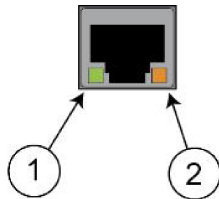

If neither of the LEDs is lit, the network is not connected.

- position 1: when lit, it indicates that the LAN port is connected.
- Position 2: When flashing, it indicates that the LAN port is receiving or sending a message.

Configure LAN Interface Information

By default, DHCP is on, which may enable communication over LAN. The letters DHCP stands for Dynamic Host Configuration Protocol, a protocol for assigning dynamic IP addresses to devices on a network. With dynamic addressing, a device can have a different IP address every time it connects to the network. The user can view the related information of LAN interface or configure the communication parameters in system menu.

- Automatically configure the address of the instrument.(Auto)

When selected, the instrument will first try to obtain an IP address from a DHCP server. If a DHCP server is found, the DHCP server will assign an IP address, Subnet Mask, and Default Gateway to the instrument. If a DHCP server is unavailable, the instrument will try to obtain an IP address using AutoIP. AutoIP automatically assigns an IP address, Subnet Mask, and Default Gateway addresses on networks that do not have a DHCP server.

- Manually configure the address of the instrument.(Manual)

Set the following parameter. The following information only appear when Manual is selected.

- IP Addr: This value is the Internet Protocol (IP) address of the instrument. An IP address is required for all IP and TCP/IP communications with the instrument. An IP Address consists of 4 decimal numbers separated by periods. Each decimal number ranges from 0 through 255 with no leading zeros (for example, 169.254.2.20).



Note

If neither of the LEDs is lit, the network is not connected.

- ◆ position 1: when lit, it indicates that the LAN port is connected.
- ◆ Position 2: When flashing, it indicates that the LAN port is receiving or sending a message.
- Sub Net: This value is used to enable the instrument to determine if a client IP address is on the same local subnet. The same numbering

notation applies as for the IP Address. When a client IP address is on a different subnet, all packets must be sent to the Default Gateway.

- Gateway: This value is the IP Address of the default gateway that allows the instrument to communicate with systems that are not on the local subnet, as determined by the subnet mask setting. The same numbering notation applies as for the IP Address. A value of 0.0.0.0 indicates that no default gateway is defined.
- DNS1: This field enters the primary address of the server. Contact your LAN administrator for server details. The same numbering notation applies as for the IP Address. A value of 0.0.0.0 indicates that no default server is defined.

DNS is an internet service that translates domain names into IP addresses. It is also needed for the instrument to find and display its hostname assigned by the network. Normally, DHCP discovers the DNS address information; you only need to change this if DHCP is unused or not functional.

- DNS2: This field enters the standby address of the server. Contact your LAN administrator for server details. The same numbering notation applies as for the IP Address. A value of 0.0.0.0 indicates that no default server is defined.

The operation steps to configure are as follows.

1. Press **[Shift]+[P-Set]** (System) to enter into the system menu interface.
2. Use left and right keys or rotate the knob to select **I/O Config** and press **[Enter]** key to confirm.
3. Use left and right keys or rotate the knob to select **LAN** and press **[Enter]** key to confirm.
4. Use left and right keys or rotate the knob to select **Lan Config** and press **[Enter]** key to confirm.

The first displayed menu item **IP Mode** is to configure the instrument address.

5. Press **[Enter]** key to confirm. This parameter is in modification.
 - Auto: automatically configure the addressing of the instrument;
 - Manual: manually configure the addressing of the instrument.

If Manual is selected, set the parameters such as IP Addr and Sub Net.



Note

When you set the IP address and the Gateway, if present display is one-digit as 192.168.200.1, you can press right and left keys to display 001 and modify the 1.

6. After setting, press **[Esc]** to exit.

Confirm the LAN Setting

After configuring the LAN settings, the user need to confirm the settings to make it valid in the instrument. The operation steps to confirm the LAN settings are as follows.

1. Press **[Shift]+[P-Set]** (System) to enter into the system menu interface.
2. Use left and right keys or rotate the knob to select **I/O Config** and press **[Enter]** key to confirm.
3. Use left and right keys or rotate the knob to select **LAN** and press **[Enter]** key to confirm.
4. Use left and right keys or rotate the knob to select **Lan Save** and press **[Enter]** key to confirm.
 - No: indicates refuse to save the LAN setting.
 - Yes: indicates save the LAN setting.
5. Use left and right keys or rotate the knob to select **Server_Config** and press **[Enter]** key to setting the Socket Port .
6. After setting, press **[Esc]** to exit.

Reset the LAN to the Default Settings

The operation steps to reset the LAN to the default settings are as follows.

1. Press **[Shift]+[P-Set]** (System) to enter into the system menu interface.
2. Use left and right keys or rotate the knob to select **I/O Config** and press **[Enter]** key to confirm.
3. Use left and right keys or rotate the knob to select **LAN** and press **[Enter]** key to confirm.
4. Use left and right keys or rotate the knob to select **Lan Restore** and press **[Enter]** key to confirm.
 - No: indicates refuse to reset the LAN to the default settings.
 - Yes: indicates reset the LAN to the default settings.
5. After setting, press **[Esc]** to exit.

View LAN Interface Information

The operation steps to view the LAN interface information are as follows.

1. Press **[Shift]+[P-Set]** (System) to enter into the system menu interface.
2. Use left and right keys or rotate the knob to select **I/O Config** and press **[Enter]** key to confirm.
3. Use left and right keys or rotate the knob to select **LAN** and press **[Enter]** key to confirm.

The first displayed menu item **Lan Info** Info is to view the LAN interface information.

4. Press **[Enter]** key to confirm.

5. Use left and right keys or rotate the knob to view the LAN interface information. Refer to [1.7 System Menu Reference](#) for more information.
6. After setting, press **[Esc]** to exit.

2.6.3.1 Using the Web Interface

The instrument has a built-in Web interface for monitoring and controlling the instrument via a Web browser. To use the Web interface, connect the instrument and PC over LAN and enter the instrument's IP address into the address bar at the top of your PC's Web browser, you can access the front panel control functions including the LAN configuration parameters.



- Please confirm the IP address and Gateway is configured correctly. The detailed information refer to the Configure LAN Interface Information.

By default, the login password of the Web interface defaults to 12345678. To change the password, click the Security button in the navigation bar on the left side of the window after login.

Enter the password and then click the LOGIN button, the Web Interface will appear in the browser as shown below. The following figure is just as an example and the Web interface of different models are different. The actual shown page shall be subject to the connected instrument.

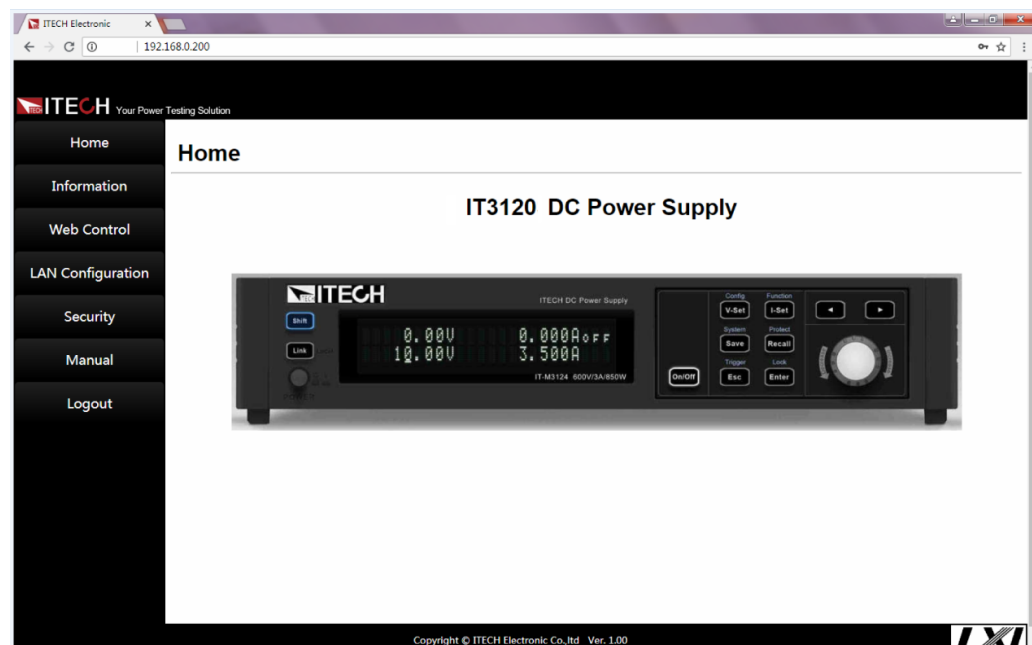

You can select different interfaces by clicking the seven buttons shown in the navigation bar on the left side of the window. The detailed descriptions are as follows.

- Home: Web home interface, displays the model and appearance of the instrument;
- Information: displays the serial number of the instrument and more system information as well as LAN configuration parameters;
- Web Control: enables the Web control to control the instrument. This page allows you to monitor and control the instrument;
- LAN Configuration: reconfigure the LAN parameters;
- Security: change the password and control access to the Web interface;
- Manual: go to the ITECH official website and view or download the relevant documents.
- Logout: logout the Web interface.

2.6.3.2 Using Sockets

CAUTION

The instruments allow up to six simultaneous socket connections to be made.

ITECH instruments have SCPI socket services, which can be used to send and receive SCPI commands, queries, and query responses. All commands must be terminated with a newline for the message to be parsed. All query responses will also be terminated with a newline.

2.6.4 RS-232 Interface

When the optional interface card is RS232+CAN interface (IT-E1207), the following can help users quickly understand the steps required to connect the RS-232 interface. The figure below shows a typical RS-232 interface system that connects to your computer using an RS-232 cable.

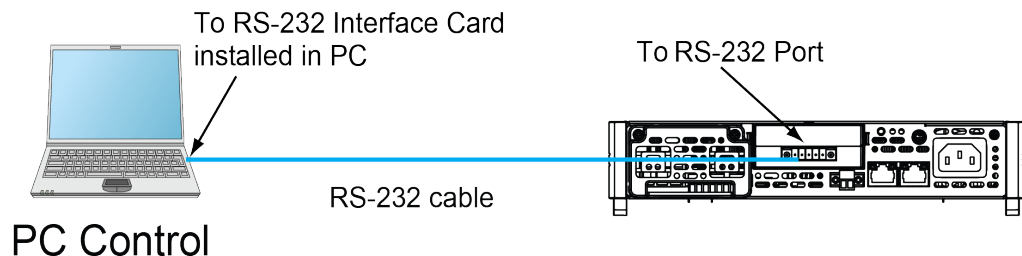

Definition of RS-232 Pins

The definition of RS-232 pins are as follows.

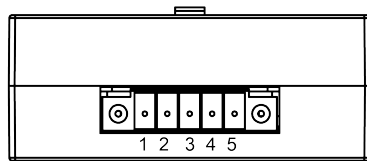

IT-E1207

Pin	Description
1	TXD , transmit data
2	RXD , receive data
3	GND
4	CAN_H
5	CAN_L

RS-232 Connection

Directly connected to the computer, as shown below:

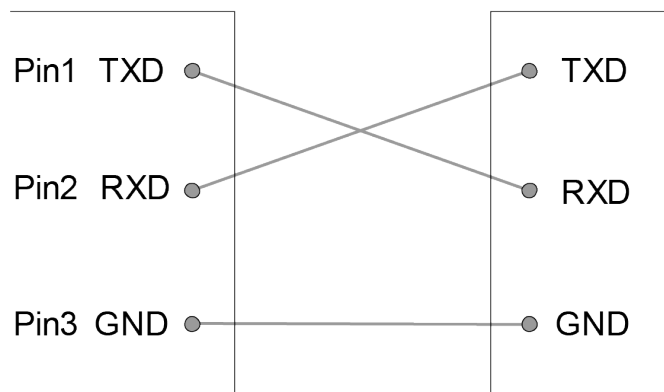

RS-232 Configuration

The user needs to configure the RS-232 interface parameters in the system menu before using the remote control. The RS-232 interface parameters are as follows.

Name	Description
Baud rate	Select the baud rate from the following options: 4800/9600/19200/38400/57600/115200
Data Bit	8 (fixed)
parity bit	None (fixed)
stop bit	1 (fixed)

The operation steps are as follows.

1. Press **[Shift]+[P-Set]**(System) to enter into the system menu interface.

2. Use left and right keys or rotate the knob to select **I/O Config** and press **[Enter]** key to confirm.
3. Use left and right keys or rotate the knob to select **RS-232** and press **[Enter]** key to confirm.

1 : RS232 = 9600_8_N_1

4. Rotate the knob to set the baud rate and press **[Enter]** to confirm.
5. Press **[Esc]** to exit.

RS-232 Troubleshooting

If you meet some problems when communicating with PC by RS-232 interface, please check the following items:

- PC and power supply must have the same baud rate.
- Ensure you have used the correct communication cable. Please pay attention that some cable may not have a correct internal wiring even it is with an appropriate interface.
- The cable must be connected to the correct serial ports (COM1, COM2, etc) of PC.

2.6.5 RS-485 Interface

When the optional interface card is a DB25 analog interface (IT-E1208) with RS-485 interface, you can quickly understand the steps required to connect the RS-485 interface.

The following figure shows a typical RS-485 interface system. Users can select the RS-485 interface converter to connect to your computer according to the actual situation, for example: RS-485 to RS-232 interface device or RS-485 to USB interface device Etc., the RS-485 to USB interface device is taken as an example.

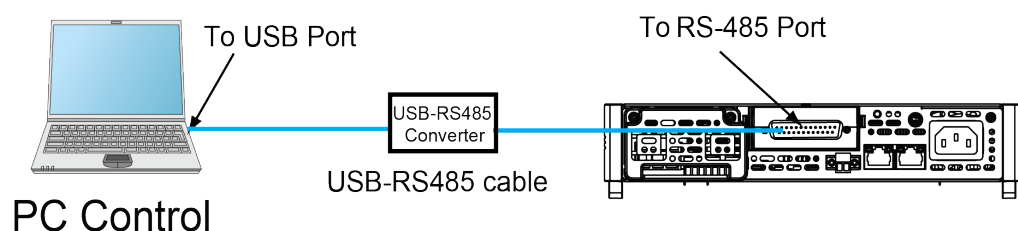

Definition of RS-485 Pins

RS-485 interface pins are integrated in the DB25 analog interface. Pin25 and Pin13 are the A and B pins for RS-485. Refer to [Figure 7-1 DB25 analog interface](#) for more information.

RS-485 Configuration

The user needs to configure the RS-485 interface parameters in the system menu before using the remote control. The RS-485 interface parameters are as follows.

Name	Description
Baud rate	Select the baud rate from the following options: 4800/9600/19200/38400/57600/115200
Data Bit	8(fixed)
Parity bit	None(fixed)
Stop bit	1(fixed)

The operation steps are as follows.

1. Press **[Shift]+[P-Set]** (System) to enter into the system menu interface.
2. Use left and right keys or rotate the knob to select **I/O Config** and press **[Enter]** key to confirm.
3. Use left and right keys or rotate the knob to select **RS485** and press **[Enter]** key to confirm.

RS-485 = 9600_8_N_1

4. Rotate the knob to set the baud rate.
5. After finishing the setting, press **[Esc]** to exit.

2.6.6 CAN Interface

When the optional interface card is RS232+CAN interface (IT-E1207), the following can help users quickly understand the steps required to connect to the CAN interface.

The following figure shows the CAN interface system. The user can select the CAN interface converter to connect to your computer according to the actual situation. Take the CAN to USB interface device as an example.

Definition of CAN Pins

The definition of CAN pins are as follows.

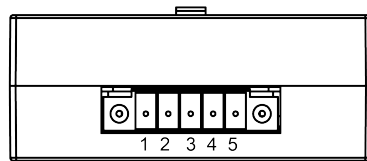

IT-E1207

Pin	Description
1	TXD , transmit data
2	RXD , receive data
3	GND
4	CAN_H
5	CAN_L

CAN Configuration

The user needs to configure the CAN interface parameters in the system menu before using the remote control. The CAN interface parameters are as follows.

Name	Description
Baud rate	Select the baud rate from the following options: 20k/40k/50k/80k/100k/125k/150k/200k/250k/400k/500k/1000k
Instrument Address	Range: 1 to 127

The operation steps are as follows.

1. Press **[Shift]+[P-Set]**(System) to enter into the system menu interface.
2. Use left and right keys or rotate the knob to select **I/O Config** and press **[Enter]** key to confirm.
3. Use left and right keys or rotate the knob to select **CAN** and press **[Enter]** key to confirm.

Baud rate = 150K

4. Use left and right keys or rotate the knob to select Baud rate and press **[Enter]** key to confirm.

Address = 1

5. Rotate the knob to set the communication address and press **[Enter]** key to confirm.
6. After finishing the setting, press **[Esc]** to exit.

CAN Troubleshooting

If you meet some problems when communicating with PC by CAN interface, please check the following items:

- PC and power supply must have the same baud rate.

- Ensure you have used the correct communication cable (CAN_H, CAN_L). Please pay attention that some cable may not have a correct internal wiring even it is with an appropriate interface.
- The interface cable is correctly connected (CAN_H to CAN_H, CAN_L to CAN_L)
- If the communication signal is poor or unstable, it is recommended to connect a 120 Ω terminating resistance.
 - The connection diagram of a single device is as below.

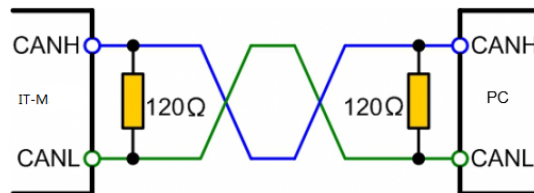

- The connection diagram of multiple devices is as below.

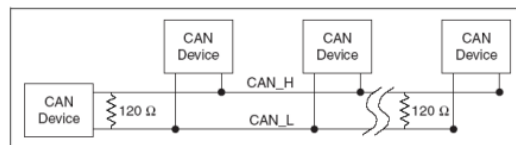

3 Getting Started

- ◆ Power-on the Instrument
- ◆ Set output parameters
- ◆ Use the Front Panel Menu
- ◆ Output On/Off Control

3.1 Power-on the Instrument

A successful selftest indicates that the purchased power product meets delivery standards and is available for normal usage. Before operation, please confirm that you have fully understood the safety instructions.

When you turn the POWER switch on for the first time after purchase, the instrument starts with its factory default settings. Each time thereafter, the instrument starts according to the setting that you selected as outlined in [7.4.2 Set the Power-on State](#).

Precautions

To prevent electric shock and damage to the instrument, please observe the following precautions.

WARNING

- **Before connecting power cord, be sure to confirm that the power voltage matches with the supply voltage.**
 - **Be sure to connect the main power socket to the power outlet with protective grounding. Do not use terminal board without protective grounding.**
 - **Ensure that the input electrodes are either insulated or covered using the safety covers provided, so that no accidental contact with lethal voltages can occur.**
 - **If you notice strange sounds, unusual odors, fire, or smoke around or from inside the instrument, flip the POWER switch to the (O) side to turn the instrument off, or remove the power cord plug from the outlet. The detachable power cord may be used as an emergency disconnecting device. Removing the power cord will disconnect AC input power to the unit.**
-

Power Switch Introduction

The power switch is located in the lower left corner of the front panel. The power switch is a button, and pressing once indicates **ON** and pressing again indicates **OFF**.

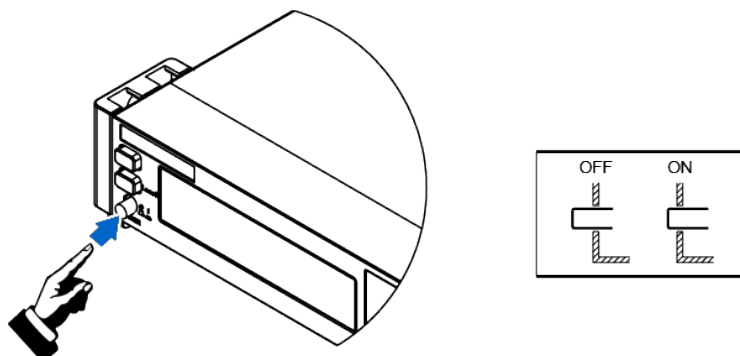

Turning the POWER Switch On

Check that the power cord is connected properly.

Flip the POWER switch to the (|) side to turn the instrument on. The front panel display will light up after a few seconds. It may take about 30 seconds or so for the power supply to initialize before it is ready for use.

If a self-test error occurs, an error message will be displayed in the front panel. Press the **[Esc]** button to try to clear the current fault status. The user can also restart the instrument to try to clear the fault status. Wait until the power is turned off and then start again. If the problem still cannot be solved after restarting, please contact the ITECH engineer. Common error messages are shown in the following table:

Error Messages	Description
Module Init Lost	The module information is lost.
Cal User Data Lose	User calibration information is lost.
Cal Factory Data Lose	Factory calibration information is lost.
Fan 1 Error!	Fan 1 is abnormal.
Fan 2 Error!	Fan 2 is abnormal.
Chan Number Conflict	The channel number is conflict.
Ms Group Confict	The master group is conflict.
Search Slave	The instrument is searching the slave.

Error Messages	Description
Wait For Master	The instrument is waiting the master.
EEProm Failure	EEProm is broken.

Note

The instrument takes approximately 30 seconds to initialize before it is ready for use.

Turning the POWER Switch Off

Flip the POWER switch to the (O) side to turn the instrument off. When it is turned off, the instrument interface will prompt “Power Down”, and the instrument will store the setting information before shutdown in the group 1 non-volatile memory.

After you turn the POWER switch off, wait at least 10 seconds after the fan stops before you turn the POWER switch back on. Turning the instrument on too soon after you turn it off can cause damage to the inrush current limiter circuit, as well as reduce the life of components such as the POWER switch and the internal input fuses.

3.2 Set output parameters

The voltage value, current value and power value can be programmed, which can be set to different parameters within the specification range based on customer requirements. This can meet various test requirements of the customer.

After the user selects the Running mode on the front panel, the instrument interface displays the parameters to be set under the existing running mode, and the cursor flashes for prompt. Or, press the knob to set parameters.

The pressing knob is introduced below.

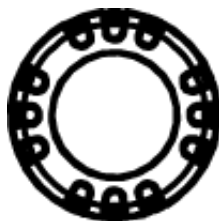

- Rotate the knob to set the data value at the cursor. The set value is increased with crosswise rotation, and decreased with counterclockwise rotation. When the knob is rotated to set parameters, automatic carrying is made

if the cursor value reaches 10, and automatic borrowing is made if the cursor value reaches 0, thus facilitating user setting. The knob can be used with the left and right arrow keys, which can move the cursor position and help user quickly set values.

- Press knob to confirm the existing setting, which equals to **[Enter]** key.



Note

The knob can also be used for scrolling display of the menu items. After the menu interface is entered, rotate the knob for scrolling display of the menu items.

3.3 Use the Front Panel Menu

The front panel provides multiple menu keys and the user can access the instrument menu by using the front panel keys, including Config menu, System menu, Protect menu and Function menu. And the user can change the related system setting in the menu. Each menu is briefly described as follows:

- The user can set the parameters related to electrical properties in the **Config** menu, including the current operation mode, slope, Output delay time, internal resistance.
- The user can set the function related to instrument system in the **System** menu, including the key beeper, Sense function, power-on state, trigger source, communication method, data logger method, digital I/O function setting, parallel function, system information and so on.
- The user can set the parameters related to instrument protection function in the **Protect** menu. Including OVP/OCP/OPP/UUT OTP/UCP/UDP.
- **Function** menu includes output/input list, / and so on. The parameters displayed in the source mode and load mode are different. Under function menu you can setting the Output list, battery charging/discharging test function, battery simulator and so on.

The user press the complex keys to enter into the menu interface. The menu is divided according to the function item and the corresponding operation is set in the lowest level menu item. For example, the key beeper is set in **System**→**Beep**. Set the Beep item to off or on. Please refer to [1.6 Configuration Menu Reference](#), [1.7 System Menu Reference](#) and the corresponding chapters for detailed menu description.

After entering the menu interface, the screen displays the optional menu. Rotate the knob or press left or right keys to view the menu items. When the number in front of the menu item is blinking, indicates this item is selected

currently. Press **[Enter]** key to enter the selected menu item and press **[Esc]** to exit the menu.

3.4 Output On/Off Control

WARNING

The **[On/Off]** key is used to turn the output/input on or off under normal circumstances. Even if the instrument is in control by PC or the keyboard is locked, the **[On/Off]** is still valid.

The **[On/Off]** key light is off and turning the output off does not place the instrument in a safe state. Hazardous voltages may be present on all output and guard terminals. Putting the equipment into an output-off state does not guarantee that the outputs are powered off if a hardware or software fault occurs. See the cautions about connecting the test lines before connecting test lines.

You can press the **[On/Off]** key on the front panel to control the output status of the power system. If the **[On/Off]** key light is on, indicates that the output is turned on. The VFD displays the meter value such as voltage, current . And displays the operating status such as CC/CV and so on. If the **[On/Off]** key light is off, indicates that the output is turned off. The VFD displays that the power supply state is OFF.

4 Output Function

- ◆ Set the Output Priority Mode
- ◆ Set the Output Voltage
- ◆ Set the Output Current
- ◆ Set the Output Power
- ◆ Set Output Slope
- ◆ Enable the Output
- ◆ Set the Internal Resistance
- ◆ CR Function in Sink Mode
- ◆ Set the Output-On/Output-Off Delay

4.1 Set the Output Priority Mode

This series instrument can set the output priority mode like CV priority or CC priority.

- Voltage priority mode keeps the output voltage constant. In voltage priority mode, the output voltage should be set to the desired value. A positive and negative current limit value should also be set. And the output is controlled by a constant-voltage feedback loop, which maintains the output voltage at its programmed setting as long as the load current remains within the positive or negative current limit settings.
- Current priority mode keeps the output current constant. In current priority mode, the output current should be programmed to the desired positive or negative value. Voltage limit range should also be set. And the output is controlled by a bi-polar constant current feedback loop, which maintains the output source or sink current at its programmed setting. The output current remains at its programmed setting, provided the load voltage remains within the voltage limit setting.

The following figure shows the CV/CC priority operating locus of the output. The area in the white quadrants shows the output as a source (sourcing power). The area in the shaded quadrants shows the output as a load (sinking power).

CV priority mode:

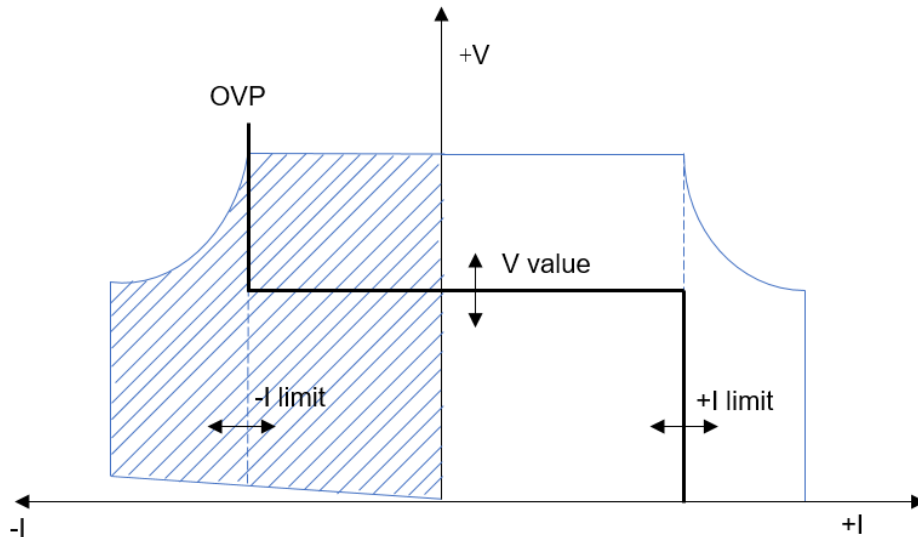

The heavy solid line illustrates the locus of possible operating points as a function of output. As shown by the horizontal portion of the line, the output voltage remains regulated at its programmed setting as long as the load current remains within the positive or negative current limit setting. A CV status flag indicates that the output voltage is being regulated and the output current is within its limit settings.

Note that when the output current reaches either the positive or negative current limit, the unit no longer operates in constant voltage mode and the output voltage is no longer held constant. Instead, the unit will now regulate the output current at its current limit setting.

As shown by the vertical portions of the shaded quadrants, the output voltage may continue to increase in the positive direction or decrease in the negative direction as current is forced into or pulled out of the unit. When the output voltage exceeds the over-voltage protection setting, the output will shut down.

CC priority mode:

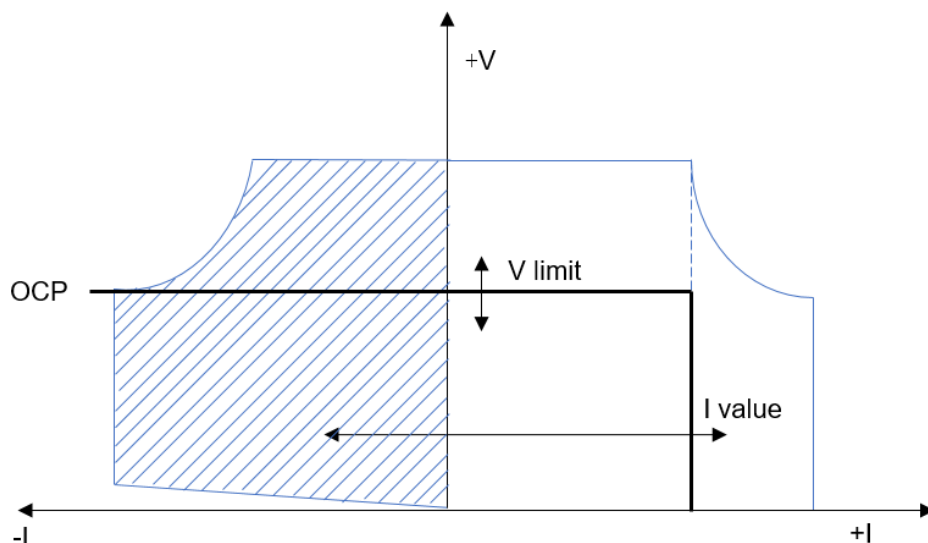

The heavy solid line illustrates the locus of possible operating points as a function of output. As shown by the vertical portion of the line, the output current remains regulated at its programmed setting as long as the output voltage remains within its limit setting. A CC (constant current) status flag indicates that the output current is being regulated and the output voltage is within its limit settings.

Note that when the output voltage reaches the upper limit, the unit no longer operates in constant current mode and the output current is no longer held constant. Instead, the unit will now regulate the output voltage at its voltage limit setting.

As shown by the horizontal portion of the shaded quadrants, when the unit is sinking power, the output current may continue to increase in the negative direction as more current is forced into the unit. This can happen when the instrument is connected to an external device such as a battery, and its output voltage is higher than the voltage limit setting of the instrument. Once the current exceeds the built-in negative over-current limit, the output will shut down. In such a case, it is important to set the voltage limit properly in order prevent this protection shutdown.

How to Set

1. Press the composite keys **[Shift]+[V-set]** (Config) to enter the Config menu.
2. Rotate the knob to select **Mode**, and press **[Enter]** to setting interface.
3. Rotate the knob to select **CV Priority** or **CC Priority** and press **[Enter]** to confirm.

When choosing different priority mode, the V-Rise Time/ V-Fall Time or I-Rise Time/ I-Fall Time configuration will be dynamically displayed in config menu.

4. Press **[Esc]** to exit.

4.2 Set the Output Voltage

The voltage setting range is between 0 to full rated output voltage, When the **[V-set]** key is pressed, the light will be lit. At this time, the voltage setting value flashes and the voltage value can be set.

- Under CV priority, press **[V-set]** to set the output voltage level.
- Under CC priority, press **[V-set]** to set the voltage high limit value, and repeat press **[V-set]** to set the VH/VL limit value. This limit limits the output voltage to a specified range.

4.3 Set the Output Current

The current setting range is between negative full rated to positive full rated output current. When the **[I-set]** key is pressed, the light will be lit. At this time, the current setting value flashes and the current value can be set.

- Under CV priority, press **[I-set]** to set current value, and repeat press **[I-set]** to set positive limit or negative limit. the limit limits the output current to a specified current range.
- Under CC priority, press **[I-set]** to set the current value.

4.4 Set the Output Power

The power setting range is from 0W to the maximum rated output power. When **[P-set]** key is pressed, the key light is lit and the output power value can be set. Press right and left keys to move the cursor and rotate the knob to adjust the value in the power setting filed and press **[Enter]** to confirm.

4.5 Set Output Slope

This series instrument is supported setting the V-Rise Time/V-Fall Time under CV priority mode and I-Rise Time/I-Fall Time under CC priority mode. The slope is the time for one voltage/current point to rise/fall to the other point under the output status is ON.

The instrument displays different slope parameters according present CC or CV priority.

- When CV priority mode: displays **V-Rise Time** and **V-Fall Time**.
- When CC priority mode: displays **I-Rise Time** and **I-Fall Time**.

The following takes the CV priority mode as an example to introduce the operation of setting slope, the setting method under CC priority mode is the same.

1. Press **[Shift]+[V-set]**(Config) to enter into the configuration menu interface.
2. Rotate the knob to select **V-Rise Time** and press **[Enter]** to confirm.
3. Use left and right keys or knob to setting the V-Rise Time and press **[Enter]** to confirm.
4. Rotate the knob to select **V-Fall Time** and press **[Enter]** to confirm.

5. Use right and left keys or knob to setting the V-Fall Time and press **[Enter]** to confirm.
6. Press **[Esc]** exit.

4.6 Enable the Output

User can press **[On/Off]** key on the front panel to control the instrument output. When receive the On/Off command, the instrument enable or disable the output according to the On/Off delay time. If the On/Off delay time set to 0, the source enable or disable output immediately. Detailed information of On/Off delay time refers to [4.9 Set the Output-On/Output-Off Delay](#).

- When **[On/Off]** key is lit, indicates the output is enabled, the VFD displays source present run mode.
- When **[On/Off]** key is lit, indicates the output is disabled, the VFD displays source state is OFF.



Note

Except front panel and SCPI OUTPut ON /OUTPut OFF, you also can control the On/Off state through 8-pin of analog interface (optional).

4.7 Set the Internal Resistance

This function is used to simulate the internal resistance of battery in battery simulation test, and it can simulate the real working state of many kinds of batteries accurately. The steps of setting as follows:

1. Press **[Shift]+[V-set]** (Config) to enter the Config menu.
2. Rotate the knob to select **Output R** and press **[Enter]** to modify.
The range of Output R refer to corresponding specification.
3. Use right and left keys and knob to set the resistance value and press **[Enter]** to confirm.
4. Press **[Esc]** to exit.

4.8 CR Function in Sink Mode

This series of instruments supports CR testing in sink mode, and the sink current capability of CR mode is limited by the current setting value in CC priority mode, and the running mode is controlled by CC+CR. For example, if

the resistance value in Sink mode is set to 10Ω , Iset is set to $-5A$, and the voltage of input power is $100V$, the maximum Sink current is $10A$ according to the conversion of $I=U/R$. However, since Iset is set to $-5A$, the actual Sink current is limited to $5A$, and the instrument is still working in CC mode at this time. If Sink Res is set to 100Ω , the maximum Sink current is $1A$, the actual sink current is $1A$, the instrument is working in CR mode at this time.

The setting method of this function is as follows:

1. Press **[Shift]+[V-set]** (Config) to enter the Config menu.
2. Rotate the knob to select **Sink R** and press **[Enter]** to setting.
3. Rotate the knob to select **On** and press **[Enter]** to setting CR value.
The range of Output R refer to corresponding specification. If the Sink R function is not enabled, you can set the resistance value to 0 or select OFF.
4. Use right and left keys and knob to set the resistance value and press **[Enter]** to confirm.
5. Press **[Esc]** to exit.

4.9 Set the Output-On/Output-Off Delay

You can set the output-on/output-off delay time within the range from 0 seconds to 10 seconds.

- On Delay is from the time that a command to turn on the output is received until the output actually turns on.
- Off Delay is from the time that a command to turn off the output is received until the output actually turns off.

The procedures to set the output delay time are as follows.

1. Press **[Shift]+[V-set]**(Config) to enter into the configuration menu interface.
2. Rotate the knob to select **On Delay** or **Off Delay** and **[Enter]**.
3. Use right and left keys or knob to set the delay time and press **[Enter]** to confirm.
4. Press **[Esc]** to exit.

5 Advanced Function

- ◆ List function
- ◆ Battery Charging/Discharging Test Function
- ◆ Battery emulation function

5.1 List function

The user can edit the test procedure composed of several steps with the List function. With List function, a total of 10 List files (List 1~List 10) can be created, and a maximum of 100 steps (Step 1~Step 100) can be configured for each List file. The user needs to edit the voltage, current and duration of each step, and set certain repeated number of times and final state for each List file. List function menu is as follows.

List	List mode		
	Run	List function switch	
	Recall	Recall and view List files	
	Recall List=1/10	Select the number of the recalled List file.	
		List Setup	View the attribute parameters of List file, which shall be consistent with List Setup edited in the Edit. The attribute parameters can only be viewed and cannot be modified.
		View Step	View the step parameters of List file, which shall be consistent with Edit Step edited in the Edit. The step parameters can only be viewed and cannot be modified.
	Edit	Edit List files (List 1~List 10)	
	Edit List=1/10	Select the number of edited List file.	
		List Setup	Edit the attribute parameters of List file
		Mode	Set the List running priority mode: <ul style="list-style-type: none"> • CC: Current mode. • CV: Voltage mode.
		I_Lim +	High limit value of positive current, which needs to be

					set when the List running mode is CV prioritized.
				I_Lim –	High limit value of negative current, which needs to be set when the List running mode is CV prioritized.
				V_High	High limit of voltage range, which needs to be set when the List running mode is CC prioritized.
				V_Low	Low limit of voltage range, which needs to be set when the List running mode is CC prioritized.
				End State	Set the running state after the List execution is finished: <ul style="list-style-type: none"> • Normal: Directly stop the waveform output after the execution is finished; • Last: Keep the last waveform unchanged after the execution is finished.
				Repeat	Set the number and range of running cycles of the List file: 1–65535
			Edit Step	Edit the step parameters of List file	
				Current/ Voltage	Current value/voltage value Based on the selected running mode display, set voltage value under the CV mode, and set current value under the CC mode.
				Slope	Slope value, with setting range of: 0.001S-3600S
				Time	Duration, with setting range of: 0.001S-3600S
				Next	Select whether to edit the next step: Yes/No
			Insert Step	Insert one step and set the step number to insert one step before the step.	
			Add Step	Add one step and set the step number to add one step after the step.	

			Delete Step	Delete the step and set the step number to delete the step.
			Delete all	Delete all steps.
			Copy File 1 to 2	Copy List file 1 to file 2.



Note

During List editing, the instrument would automatically return to the main interface if there is no operation for a long period.

Operation Steps:

1. Press **[Shift]+[I-set]**(Function) composite key, and enter the Function menu page.
2. Rotate the knob, select "List", and press **[Enter]** key for confirmation. Enter the List function setting page.
3. Rotate the knob to select running List file (Run), recalling List file (Recall) and editing List file (Edit) in successive.

Run Recall Edit

4. Select different functions for setting. For detailed information about List file editing, recalling and running, please refer to the specific introduction below.



Note

The running, recalling and editing of List function are mutual prerequisites. When the system has no existed List file, it is necessary to edit List file, recall List file, and finally run the recalled List file.

Edit List files

1. In the List function setting interface, select **Edit**, and enter the List file editing menu.
2. At first, select the number of file to be edited. A maximum of 10 List files can be edited in this instrument.

Edit List = 1/10

3. Press **[Enter]** key for confirmation. Enter the List editing page.

1: List Setup
 2: Edit Step= 1/1
 3: Insert Step= 1/1
 4: Add Step= 1/1
 5: Delete Step= 1/1

```
6: Delete All= 1/1
7: Copy File 1 To 1
```

4. Select **“List Setup”**, and press **[Enter]** key for confirmation. Set the attribute parameters of the List file in successive.

The setting method for each item is the same. Select one item, and press **[Enter]** key for confirmation. When the item is under Edit state, rotate the knob to select the configuration value or set the value. Taking the CV mode as an example, the interface display is as follows. The displayed voltage and current are different under different modes.

```
1: Mode= CV
2: I_Lim+= 2.00A
3: I_Lim-= -2.00A
4: End State= Last
5: Repeat= 01
```

5. Select **“Edit Step= x/y”**, and press **[Enter]** key for confirmation. Select the number x of List step to be edited, press **[Enter]** key, and enter the Step parameter editing page.

“x” means the number of step to be edited, and “y” means the total number of steps of the List. The total number of steps will be updated automatically according to the step number increase or decrease.

- If the existing List file is a new and empty file, display Edit Step= 1/1. The user cannot select the number of step to be edited, and can only start editing from step 1.
- If the existing List file is an existed file, display Edit Step= 1/6. The user can select the number of any step for editing and modification. In this example, the number “6” is only taken as an example.

6. Rotate the knob to set the parameters of Step 1 for this List file in successive.

```
Edit Step= 1/1
Voltage= 0.000V
Slope= 0.0S
Time= 0.0S
Edit Next=No/Yes
```

When “Edit Next” is set to “Yes”, skip to the editing interface of next step. Repeat Step 6 to continue editing the parameter values of Step 2 of the List file; when “Edit Next” is set to “No”, finish the parameter editing of List steps.

7. If need to adjust the existing List file, select the setting item below for inserting, adding and deleting steps.
 - “Insert Step= 2/6”: Insert one step before the selected Step 2 to add 1 step in Step 6;
 - “Add Step= 2/6”: Add one after the selected Step 2 to add 1 step in Step 6;
 - “Delete Step= 2/6”: Delete the selected Step 2;

- “Delete all= No/Yes”: When “Yes” is selected, clear all steps in the existing List file, and recover all attribute values to system default values. When “No” is selected, do not clear steps.
- “Copy File 1 to 2”: Execute this step and copy existing List 1 file to List 2 file.

Recall and view List files

If several List files have been edited, select one List file for execution. Or, the user can view information of the recalled List file in the recall interface.

1. In the List function setting interface, select “**Recall**”, and press **[Enter]** key for confirmation.
2. Rotate the knob to set the number of List file to be recalled. Press **[Enter]** key to enter the viewing interface.

When the selected number is empty, the interface would prompt that the recalled file is empty. The user needs to select the file again or return and enter the Edit menu for editing.

3. After successful recall, the user can view the setting information of the existing List file. The following parameters can only be viewed, and cannot be edited. To modify them, please return and enter the Edit menu to select the corresponding file number for editing.

```
1: List Setup
2: View Step=1/6
```

4. Rotate the knob, select “List Setup”, and press **[Enter]** key for confirmation. Rotate the knob to view the attribute parameters of the List file in successive. The contents are consistent with the List Setup contents during editing of the List file.
5. Rotate the knob, select “View Step=1/6”, and press **[Enter]** key for confirmation. Set the number of List step to be viewed, and press **[Enter]** key to enter the parameter viewing page of the selected Step.

```
S001 Value=1.000V
S001 Slope=0.001S
S001 Time=0.005S
S002 Value=2.000V
S002 Slope=0.001S
S002 Time=0.005S
...
```

Rotate the knob for scrolled viewing of parameters of all Steps of the List. The voltage and current parameters in the step vary with the existing List mode.

6. Press **[Esc]** key, and exit the existing page.

Run List file

After the List files are edited, the user needs to enable the List function and return to the main interface to trigger the running.

1. Select the List file to be run in the Recall List.
2. In the List function setting interface, select “Run”, and press **[Enter]** key to confirm that the instrument automatically returns to the main interface and waits for trigger.

```
0.000V    0.0000A
0.0W      WTG
```

3. Press **[On/Off]** to turn on the instrument output.
4. Conduct trigger based on the trigger mode set in the system menu, such as front panel trigger mode. Press **[Shift]+[On/Off]** (Trigger) key for triggering, and the instrument would output based on set sequence.

```
12.000V    5.0000A
100.00W    RUN
```

Stop running and re-running

During the running of List file or when the running is finished, the interface displays END. Press **[Shift]+[I-set]**(Function) composite key, and the instrument interface displays the running state control interface of the existing file. The user can press **Stop** to stop existing test and turn off the List function. Or, press **Reset** to restart a new test.

5.2 Battery Charging/Discharging Test Function

Precautions

Please confirm that you have understood the general safety precautions before connection. Please pay special attention to the following safety precautions when connecting the battery.

WARNING

- **To avoid battery short circuit, be sure to check that the test line end is not connected when connecting or disassembling the test line. When the test line end is connected with battery, short circuit may cause severe accident.**
- **To avoid the damage of the instrument, please make sure the positive and negative electrodes of the electrode when connecting the battery and other energy storage equipment. The reverse connection of the battery is not allowed in the instrument. When wiring, you can choose the battery anti-reverse connection module provided by ITECH.**
- **If you need to pull out the green output terminal, please lift it up and pull it out, otherwise it will damage the instrument.**

This series provides the battery charging and discharging test function . The user can edit 10 test files, and can recall these files to execute test.

Bat- tery	Battery test function		
Run	Turn the battery test function on.		
Recall	Recall battery test file.		
	Recall Batt=1/10	Select battery test file number, the total of file number is ten, when the selected file dose not exist, empty file will be prompted.	
		Batt Mode Disch/Charge V Disch/Charge I Disch/Charge Time Cut Off V Cut Off I Cut Off Q	Enter the test file viewing interface, parameter setting shall be consistent with parameter in Edit menu. When recall the files, the parameters can only be viewed and can't be modified.
Edit	Edit the battery charging/discharging test file.		
	Edit File= 1/10	Select the test file, the total of file number is ten.	
		Batt Mode	Battery test mode, charging mode and discharging mode can be select.
			Charge Battery charging mode
			Discharge Battery discharging mode
		Disch/Charge V	Set the charging voltage or discharging voltage. The displayed value is different under charge mode and discharge mode.
		Disch/Charge I	Set the charging current or discharging current. The displayed value is different under charge mode and discharge mode.
		Disch/Charge Time	Set the charging or discharging time.
		Cut Off V	Set the cut off voltage.
		Cut Off I	Set the cut off current.
		Cut Off Q	Set the cut off capacity.



Note

During editing, the instrument would automatically return to the main interface if there is no operation for a long period.

operation steps:

1. Under source mode, press **[Shift]+[I-set]**(Function) to enter into the function menu interface.
2. Rotate the knob to select **Battery**, and press **[Enter]**.
3. Rotate the knob to select Run, Recall, Edit in turn.

Run Recall Edit

4. Select different functions for setting, for detailed operation about battery file editing, recalling and running, please refers to following introduction.



Note

The running, recalling and editing of List function are mutual prerequisites. When the system has no existed battery test file, it is necessary to edit battery test file, recall battery test file, and finally run the recalled battery test file.

Edit Battery Test File

1. In the battery test function setting interface, select the **Edit** and enter to the edit file menu.
2. Select the desired file number to be edit. The maximum file number is 10.

Edit File = 1/10

3. Press **[Enter]** to confirm. Take the charging mode as an example.

```
1 : Batt Mode= Charge
2 : Charge V = 1.00V
3 : Charge I = 1.00A
4 : Charge Time = 60S
5 : Cut Off V = 8.00V
6 : Cut Off I = 5.00A
7 : Cut Off Q = 10AH
```

When Batt Mode set to Discharging, perform discharging test, discharging voltage/current/time can be displayed in the user interface. Users according to needs to choose discharging or charging mode.

4. Set the attribute parameters of the List file in successive. After setting press **[Esc]** to exit.

Recall and view battery test file

1. In the battery test function setting interface, select the **Recall** and enter to the edit file menu.

2. Rotate the knob to set the number of List file to be recalled. A maximum of 10 battery test files can be recalled in this instrument.

Recall Batt = 1/10

When the selected number is empty, the interface would prompt that the recalled file is empty. The user needs to select the file again or return and enter the Edit menu for editing.

3. After successful recall, the user can view the setting information of the existing battery test file. The test parameters can only be viewed, and cannot be edited. To modify them, please return and enter the Edit menu to select the corresponding file number for editing.
4. Press [**Esc**] key, and exit the existing page.

Run Battery test file

After the battery test files are edited, the user needs to select **Run** to enable the battery test function and return to the main interface to trigger the running.

```

12.000V    10.000A
00:00:01   0.00Ah
  
```

- First line: The voltage and current value.
- Second line: testing time and battery capacity.

During testing, if there is no SDS module, the alert box will appear with "No SDS Module Detected, Continue? No/Yes", after select "Yes", the testing will be continued. As long as any one of the cut-off conditions is met, the test stops.

Stop running and re-running

During the running of battery test file, press [**Shift**]+[**I-set**](Function) composite key, and the instrument interface displays the running state control interface of the existing file. The user can press **Stop** to stop existing test and turn off the List function. Or, press **Reset** to restart a new test.

5.3 Battery emulation function

the user can emulate the battery charge and discharge properties due to the unique current bipolarity design and variable output impedance. In the battery emulation function, the instrument can emulate the scenes where several batteries are in parallel connection/serial connection, and set the initial state of charge of the battery based on needs for true emulation of various states of the battery to meet various test requirements of the user.

During the emulation of charge and discharge test functions of the battery, the user needs to set battery-related attributes, such as full-state voltage value,

empty-state voltage value, internal resistance value and capacity. Set the parallel connection and serial connection for emulation batteries, as well as the positive and negative current limits of the battery group.

Batt Emulator	Battery emulation test function		
	Run	Run battery emulation function	
		Initial SOC	Set the initial state of charge of battery
	Recall	Recall the battery emulation file to be run	
		Recall File=1/10	Select the number of file to be recalled. The total number of files is 10. When the selected file does not exist, the instrument would prompt that the file is empty.
		Cell Properties	During Recall, the user can only view the battery attribute, and cannot edit it.
			Full Volt: Battery voltage value under full state Empty Volt: Battery voltage value under empty state Inner R: Battery internal resistance value Capacity: Battery capacity —EXIT—: Return to the previous level
		Parallel	Set the number of emulation batteries in parallel connection
		Series	Set the number of emulation batteries in serial connection
		I_Limit +	Positive current limit value, maximum discharge current of battery emulation group
		I_Limit -	Negative current limit value, maximum charge current of battery emulation group
		—EXIT—	Return to the previous level
	Edit	Edit battery emulation file	
		Edit File=1/10	Select the number of file to be edited. A maximum of 10 List files can be edited.
		Cell Properties	Battery attribute setting, to be set based on the emulation battery specification
			Full Volt: Battery voltage value under full state Empty Volt: Battery voltage value under empty state Inner R: Battery internal resistance value

				Capacity: Battery capacity —EXIT—: Return to the previous level
			Parallel	Set the number of emulation batteries in parallel connection, with setting range of: 1–99
			Series	Set the number of emulation batteries in serial connection, with setting range of: 1–99
			I_Limit +	Positive current limit value, maximum discharge current of battery emulation group
			I_Limit –	Negative current limit value, maximum charge current of battery emulation group
			—EXIT—	Return to the previous level

Operation steps

1. Under the source mode, press **[Shift]+[I-set]**(Function) composite key, enter the Function menu page.
2. Rotate the knob and select **Batt Emulator**. Press **[Enter]** key and enter the battery emulation function setting page.
3. Rotate the knob to select running battery emulation file (Run), recalling battery emulation file (Recall) and editing battery emulation file (Edit) in successive.

Run Recall Edit

4. Select different functions for setting. For details, refer to the introduction of specific operation.

Edit battery emulation file

1. In the setting interface of battery emulation function, select **Edit**, and enter the battery emulation file editing menu.
2. At first, select the number of file to be edited. A maximum of 10 battery emulation files can be edited in this instrument.

Edit Emul = 1/10

3. Edit the following parameters of this battery emulation file in successive. Press **[Enter]** key to confirm setting.

1: Cell Properties

2: Parallel =1

```
3: Series =1
4: I_Limit + = 2.00A
5: I_Limit - = -2.00A
6: - -EXIT- -
```

- Cell Properties: Set the battery properties, including full-state voltage value, empty-state voltage value, internal resistance value and capacity value. The user can conduct setting based on battery specifications to be emulated.
 - Parallel: This function can emulate the state of several batteries in parallel connection. For example, when “2” is set, the battery emulated in the instrument is a battery group composed of two batteries in parallel connection.
 - Serial: This function can emulate the state of several batteries in serial connection. For example, when “2” is set, the battery emulated in the instrument is a battery group composed of two batteries in serial connection.
 - I_Limit+/I_Limit-: Maximum current limit value for battery discharge or charge. To be set based on DUT specifications.
4. After editing, press **[Esc]** to exit the menu. The instrument returns to the setting interface of battery emulation function.

Recall battery emulation file

1. In the setting interface of battery emulation function, select **Recall**, and enter the recall battery emulation file menu.
2. At first, select the number of file to be recalled. A maximum of 10 battery emulation files can be existed in this instrument.

```
Recall Emul = 1/10
```

When the selected number is empty, the interface would prompt that the recalled battery emulation file is empty. The user needs to select the file again or return and enter the Edit menu for editing.

3. After successful recall of battery emulation file, the user can view the setting information of the existing battery emulation file. The following parameters can only be viewed, and cannot be edited. To modify them, please return and enter the Edit menu to select the corresponding file number for editing.

```
1:Cell Properties
2:Parallel =1
3:Series =1
4:I_Limit + = 2.00A
5:I_Limit - = -2.00A
6:- -EXIT- -
```

4. After successful recall, press **[Esc]** to exit the menu. The instrument returns to the setting interface of battery emulation function.

Run battery emulation file

1. In the setting interface of battery emulation function, select **Run** to start running battery emulation function.
2. During running of battery emulation file, the user needs to set the state of charge of existing battery.

Initial SOC = 0.00%

3. Press **[Enter]** key. After confirmation, the instrument returns to the main interface, as shown below:

```
12.000V    10.000A
 0.00AH    0.00%SOC
```

- First line: Voltage and current value of existing circuit.
- Second line: Capacity and state of charge of existing battery.



Note

During the charge and discharge test, battery overcharge and overdischarge protection is supported. When the charging capacity is higher than 110% or the discharging capacity is lower than -10%, the test would be stopped automatically.

Stop running and re-running

During running of the battery emulation file, press **[Shift]+[I-set]**(Function) composite key, and the instrument interface displays the running state control interface of the existing file. The user can press **Stop** to stop existing test and turn off the battery emulation function. Or, press **Reset** to restart a new test. When **Reset** is selected, the user needs to reset the state of charge of the existing battery and re-start a new test.

6 Protect Function

- ◆ Protect Function Setting
- ◆ Set Over-Voltage Protection
- ◆ Set Over-Current Protection
- ◆ Set Over-Power Protection
- ◆ Set Under-Current Protection
- ◆ Set Under-Voltage Protection
- ◆ UUT Over-Temperature Protection
- ◆ Sense abnormal protection function
- ◆ Over-Temperature Protection
- ◆ Set foldback protection

6.1 Protect Function Setting

this series power supplies provide the following protection functions. You can set these functions in the Protect menu. Press **[Shift]+[R-set]** (Protect) key to enter into Protect menu. The descriptions of protect menu are listed in the table below.

Protect	Protection function menu			
	OVP	Over-voltage protection.		
		Off	Turn the OVP function off.	
		On	Level	Over-voltage protection point.
			Delay	Delay time.
	OCP	Over-current protection.		
		Off	Turn the OCP function off.	
		On	Level	Over-current protection point.
			Delay	Delay time.
	OPP	Over-power protection.		
		Off	Turn the OPP function off.	
		On	Level	Over-power protection point.
			Delay	Delay time.
	UUT OTP	UUT Over-temperature protection.		
		Off	Turn the UUT OTP function off.	
		On	Level	UUT OTP point
UCP	Under-current protection.			

		Off	Turn the UCP function off.		
		On	Warm-up	Warm-up time.	
			Level	Under-current protection point.	
			Delay	Delay time.	
	UVP	Under-voltage protection.			
		Off	Turn the UVP function off.		
		On	Warm-up	Warm-up time.	
			Level	Under-voltage protection point.	
Delay			Delay time.		

6.2 Set Over-Voltage Protection

Over-voltage protection function allows the user to enable the protection and set a over-voltage limit (Level) and delay time (Delay). This function prevents the output voltage from being higher than the limited output voltage and protects the connected DUT so it this is not over-voltage and possibly damaged due to an excessive voltage.

An over-voltage protection will occur if:

- Enable OVP;
- The output voltage value is greater than the set voltage protection point Level and the period is greater than the set protection delay time Delay.

Enable OVP

1. Press **[Shift]+[R-set]**(Protect) to enter Protect menu interface.
2. Rotate the knob to select **OVP** and press **[Enter]** key to confirm.
3. Rotate the knob to select **On** and press **[Enter]** key to confirm.
4. Rotate the knob to adjust the over-voltage limit Level and press **[Enter]** key to confirm.
5. Rotate the knob to adjust the delay time Delay and press **[Enter]** key to confirm.
6. Press **[Esc]** to exit.

Delay Time

You can specify an OVP delay to prevent momentary output settings, DUT and status changes from tripping the over-voltage protection. In most cases these momentary conditions would not be considered an over-voltage protection fault, and having an OVP condition disable the output when they occur would be a

nuisance. Specifying an OVP delay lets the OVP circuit ignore these momentary changes during the specified delay period. Once the OVP delay time has expired and the over-voltage condition persists, the output will shut down.

Clear OVP Protection

When over-voltage protection occurs, the instrument responds as follows:

- Instrument output is off;
- The buzzer sounds;
- The interface displays “Over Voltage Protect” and flashes
- Status register, the OV status bit is set to 1.

To clear the over-voltage and return to normal operation, firstly remove the conditions that caused the protection fault. Press **[Esc]** key (or send the command PROTection:CLEar) to clear the protection status. The “Over Voltage Protect” displayed in front panel is cleared and the instrument exits OVP status.

6.3 Set Over-Current Protection

Over-current protection function allows the user to enable the protection and set a over-current limit (Level) and delay time (Delay). This function prevents the output current from being higher than the limited output current and protects the connected DUT so it this is not over-current and possibly damaged due to an excessive current.

An over-current protection will occur if:

- Enable OCP;
- The output current value is greater than the set current protection point Level and the period is greater than the set protection delay time Delay.

Enable OCP

1. Press **[Shift]+[R-set]**(Protect) to enter Protect menu interface.
2. Rotate the knob to select OCP and press **[Enter]** key to confirm.
3. rotate the knob to select On and press **[Enter]** key to confirm.
4. Rotate the knob to adjust the over-current limit Level and press **[Enter]** key to confirm.
5. Rotate the knob to adjust the delay time Delay and press **[Enter]** key to confirm.
6. Press **[Esc]** to exit.

Delay time

You can specify an OCP delay to prevent momentary output settings, DUT and status changes from tripping the over-current protection. In most cases these momentary conditions would not be considered an over-current protection fault, and having an OCP condition disable the output when they occur would be a nuisance. Specifying an OCP delay lets the OCP circuit ignore these momentary changes during the specified delay period. Once the OCP delay time has expired and the over-current condition persists, the output will shut down.

Clear Over-Current Protection

When over-current protection occurs, the instrument responds as follows:

- Instrument output is off;
- The buzzer sounds;
- The interface displays “Over Current Protect” and flashes;
- Status register, the OC status bit is set to 1;

To clear the over-current and return to normal operation, firstly remove the conditions that caused the protection fault. Press **[Esc]** key (or send the command PROTection:CLEar) to clear the protection status. The “Over Current Protect” displayed in front panel is cleared and the instrument exits OCP status.

6.4 Set Over-Power Protection

Over-power protection function allows the user to enable the protection and set a over-power limit (Level) and delay time (Delay). This function prevents the output power from being higher than the limited output power and protects the connected DUT so it this is not over-power and possibly damaged due to an excessive power.

An over-power protection will occur if:

- Enable OPP;
- The output power value is greater than the set power protection point Level and the period is greater than the set protection delay time Delay.

Enable OPP

1. Press **[Shift]+[R-set]**(Protect) Protecto to enter Protect menu interface.
2. Rotate the knob to select OPP and press **[Enter]** key to confirm.
3. rotate the knob to select On and press **[Enter]** key to confirm.

4. Rotate the knob to adjust the over-power limit Level and press **[Enter]** key to confirm.
5. Rotate the knob to adjust the delay time Delay and press **[Enter]** key to confirm.
6. Press **[Esc]** to exit.

Delay time

You can specify an OPP delay to prevent momentary output settings, DUT and status changes from tripping the over-power protection. In most cases these momentary conditions would not be considered an over-power protection fault, and having an OPP condition disable the output when they occur would be a nuisance. Specifying an OPP delay lets the OPP circuit ignore these momentary changes during the specified delay period. Once the OPP delay time has expired and the over-power condition persists, the output will shut down.

Clear Over-Power Protection

When over-power protection occurs, the instrument responds as follows:

- Instrument output is off;
- The buzzer sounds;
- The interface displays “Over Power Protect” and flashes;
- Status register, the OP status bit is set to 1;

To clear the over-power and return to normal operation, firstly remove the conditions that caused the protection fault. Press **[Esc]** key (or send the command PROTection:CLEar) to clear the protection status. The “Over Power Protect” displayed in front panel is cleared and the instrument exits OPP status.

6.5 Set Under-Current Protection

Output under-current protection is for the DUT sensitive to the current under CC mode, under-current protection function allows the user to enable the protection and set a under-current limit (Level), delay time (Delay) and warm-up time (Warm Up).

- Enable UCP;
- The output time exceeds the warm-up time;
- The output current value is less than the set current protection point Level and the period is greater than the set protection delay time Delay.

Enable UCP

1. Press **[Shift]+[R-set]**(Protect) to enter Protect menu interface.
2. Rotate the knob to select **UCP** and press **[Enter]** key to confirm.
3. rotate the knob to select **On** and press **[Enter]** key to confirm.
4. Rotate the knob to adjust the warm-up time **Warm Up** and press **[Enter]** key to confirm.
5. Rotate the knob to adjust the under-current limit Level and press **[Enter]** key to confirm.
6. Rotate the knob to adjust the delay time Delay and press **[Enter]** key to confirm.
7. Press **[Esc]** to exit.

Warm Up time

You can specify the warm-up time for UCP protection to make the instrument not judge the under-current protection fault within the specified warm-up time.

Delay time

You can specify an UCP delay to prevent momentary output settings, DUT and status changes from tripping the under-current protection. In most cases these momentary conditions would not be considered an under-current protection fault, and having an UCP condition disable the output when they occur would be a nuisance. Specifying an UCP delay lets the UCP circuit ignore these momentary changes during the specified delay period. Once the UCP delay time has expired and the under-current condition persists, the output will shut down.

Clear Under-Current Protection

When under-current protection occurs, the instrument responds as follows:

- Instrument output is off;
- The buzzer sounds;
- The interface displays “Under Current Protect” and flashes;
- Status register, the UC status bit is set to 1;

To clear the under-current and return to normal operation, firstly remove the conditions that caused the protection fault. Press **[Esc]** key (or send the command PROTection:CLEar) to clear the protection status. The “Under Current Protect” displayed in front panel is cleared and the instrument exits UCP status.

6.6 Set Under-Voltage Protection

Output under-voltage protection is for the DUT sensitive to the voltage under CV mode, under-voltage protection function allows the user to enable the protection and set a under-voltage limit (Level), delay time (Delay) and warm-up time (Warm Up). An under-voltage protection will occur if:

- Enable UVP;
- The output time exceeds the warm-up time;
- The output voltage value is less than the set voltage protection point Level and the period is greater than the set protection delay time Delay.

Enable UVP

1. Press **[Shift]+[R-set]**(Protect) to enter Protect menu interface.
2. Rotate the knob to select **UVP** and press **[Enter]** key to confirm.
3. rotate the knob to select **On** and press **[Enter]** key to confirm.
4. Rotate the knob to adjust the warm-up time **Warm Up** and press **[Enter]** key to confirm.
5. Rotate the knob to adjust the under-voltage limit Level and press **[Enter]** key to confirm.
6. Rotate the knob to adjust the delay time Delay and press **[Enter]** key to confirm.
7. Press **[Esc]** to exit.

Warm-up time

You can specify the warm-up time for UVP protection to make the instrument not judge the under-voltage protection fault within the specified warm-up time.

Delay time

You can specify an UVP delay to prevent momentary output settings, DUT and status changes from tripping the under-voltage protection. In most cases these momentary conditions would not be considered an under-voltage protection fault, and having an UVP condition disable the output when they occur would be a nuisance. Specifying an UVP delay lets the UVP circuit ignore these momentary changes during the specified delay period. Once the UVP delay time has expired and the under-voltage condition persists, the output will shut down.

Clear Under-voltage Protection

When under-voltage protection occurs, the instrument responds as follows:

- Instrument output is off;

- The buzzer sounds;
- The interface displays “Under Voltage Protect” and flashes;
- Status register, the UV status bit is set to 1;

To clear the under-voltage and return to normal operation, firstly remove the conditions that caused the protection fault. Press **[Esc]** key (or send the command PROTECTION:CLEAR) to clear the protection status. The “Under Voltage Protect” displayed in front panel is cleared and the instrument exits UVP status.

6.7 UUT Over-Temperature Protection

UUT over-temperature protection function allows the user to enable the protection and set a over-temperature limit (Level). This function monitors the temperature of UUT and prevents the UUT damaged due to higher temperature. The operation procedures refer to [7.5 Measuring the DUT Temperature](#).

An UUT over-temperature protection will occur if:

- enable UUT OTP
- The temperature of UUT is greater than the set protection point level.

Enable UUT OTP

1. Press the composite keys **[Shift]+[R-set]**(Protect) to enter the Protect menu.
2. Rotate the knob to select **UUT OTP** and press **[Enter]** to confirm.
3. Rotate the knob to select **On** and press **[Enter]** to confirm.
4. Rotate the knob and adjust the protection point **Level** and press **[Enter]** to confirm.
5. Press **[Esc]** to exit.

Clear UUT OTP

When UUT OTP protection occurs, the instrument responds as follows:

- Instrument output is off;
- The buzzer sounds intermittently;
- The interface displays “UUT Over Temperature” and flashes;
- Status register, the UUT OT status bit is set to 1

To clear the UUT OTP and return to normal operation, firstly remove the conditions that caused the protection fault. Press **[Esc]** key (or send the

command PROTECTION:CLEAR) to clear the protection status. The “UUT Over Temperature” displayed in front panel is cleared and the instrument exits OCP status.

6.8 Sense abnormal protection function

When the Remote Measure Function (Sense Function) is enabled, after the instrument's On/Off switch is turned on, automatically detect the wiring conditions of the Sense+ and Sense- terminals on the rear panel. If the Sense interface is not connected or reversed connected, the instrument would make judgment based on the measured voltage data. When the voltage difference between the local voltage and remote voltage is greater than a certain value and such condition continues for a period, the instrument would report Sense abnormal protection and turn off the output. The output voltage is subject to local voltage, and the instrument interface would prompt “Sense Protect”. This protection can prevent the instrument from outputting high voltage when the Sense terminal is not wired or when the line is loosened or reverse-connected under Remote Measure state, which may damage the DUT.

The Sense Protect will be triggered when the instrument state meets the following conditions.

- The Sense Measure function is enabled in the Sestem menu.
- On/Off is turned on;
- The voltage difference between the local voltage measured by the instrument and the remote voltage exceeds the specification value internally set by the instrument;

The Sense reverse protection is always enabled, and the user does not need to set up or turn on it. In the case of Sense reverse protection, On/Off is turned off. The user needs to check the wiring conditions of the Sense+ and Sense- terminals on the rear panel, and eliminate abnormal conditions. Press **[Esc]** key (or send command PROTECTION:CLEAR) to clear the protection state. The “Sense Protect” on the front panel of the instrument disappears, and the instrument exits the Sense abnormal protection status.

6.9 Over-Temperature Protection

An Over Temp Protect will occur if:

- The internal temperature of the instrument exceeds 85 degrees
- Fan fault

- The failure of internal temperature sensor.

Clear Over-Temperature Protection

When Over-Temperature Protection occurs, the instrument responds as follows:

- Instrument output is off.
- The buzzer sounds 3 times intermittently with intermittence of 2 seconds.
- The interface displays “Under Current Protect” or “Fan Failure” and flashes or the failure of the temperature sensor "Temp Sensor Failure";
- Status register, the OT status bit is set to 1 or FAN_FAIL status bit is set to 1.

To clear the OTP and return to normal operation, firstly remove the conditions that caused the protection fault. Press [Esc] key (or send the command PROTECTION:CLEAR) to clear the protection status. The prompt displayed in front panel is cleared and the instrument exits OTP status.

6.10 Set foldback protection

This series instrument comes with Foldback protection function for turning off the output during CV/CC switch of the power supply to protect DUT sensitive to voltage overshoot or current overshoot. Foldback protection allows users to specify a working mode and set protection delay time. If there is any switch between existing working modes, the protection is triggered and the output is turned off from the time when the working loop switches to trigger protection and the delay time depletes.

- Enable FOLDBACK function;
- The existing loop is switched to set working mode, and the duration is longer than the set protection delay time;

Enable FOLDBACK function

1. Press **[Shift]+[R-set]**(Protect) composite key, and enter the Protect configuration menu page.
2. Rotate the knob to select **FOLDBACK**, and press **[Enter]** key to enter the setting interface.
3. Rotate the knob to select **CC** or **CV** and press **[Enter]** key.
 - If CC is selected, it indicates that the instrument triggers protection when the running mode is switched to CC mode.

- If CV is selected, it indicates that the instrument triggers protection when the running mode is switched to CV mode.
 - If OFF is selected, it indicates that the foldback function is turned off.
4. Rotate the knob to adjust the instrument delay time **Delay**, and press **[Enter]** key for confirmation.
 5. Press **[Esc]** key to exit the protection menu setting.

Delay FOLDBACK

You can specify a time for FOLDBACK delay so that the instrument can omit transient change of running mode within the specified delay range. In most cases, this transient condition is not deemed as switch state. At this moment, it is unnecessary to trigger the foldback function and disable output. Once the FOLDBACK delay time is exceeded, the output is turned off.

Clear foldback protection

In case of output undervoltage protection, the instrument has the following responses:

- The instrument output is turned off;
- The buzzer beeps once;
- The interface displays “Foldback Protect” and flashes;
- State register, FLDBK state position 1.

To clear output undervoltage and recover to normal running state, please delete the conditions leading to protection fault. Press **[Esc]** key (or send command PROTECTION:CLEAR) to clear the protection state. The **Foldback Protect** on the front panel of the instrument disappears, and the instrument exits the Foldback protection state.

7 System-Related Functions

- ◆ Key Lock Function
- ◆ Save and Recall Operations
- ◆ Local/Remote Mode Switch
- ◆ Basic Operation
- ◆ Measuring the DUT Temperature
- ◆ Observe the Regenerative power and Capacity
- ◆ External analog function (optional)
- ◆ Anti-reverse connection module function (optional)

7.1 Key Lock Function

This function can prevent the instrument from the panel keys misoperation during usage. Press the composite keys **[Shift]+[Enter]** (Lock) to lock front panel keys and the front panel display a key symbol. All panel keys are locked, except for **[On/Off]**, **[Shift]+[Enter]** (Lock) keys. You can repress **[Shift]+[Enter]** (Lock) to unlock the front panel.

7.2 Save and Recall Operations

The power system can save up to 10 common parameters in nonvolatile memory for user to recall conveniently.





The saved settings in source mode include the following parameters.

Category	Parameters
Home screen	Under CV priority mode: voltage setting value, I+ and I-limit of current, power setting value.
	Under CC priority mode: voltage setting value, current setting value and power setting value.
Config menu	Priority mode
	Output Resistance



The saved settings in load mode include the following parameters .

Category	Parameters
Home screen	The voltage setting value under CV mode
	The current setting value under CC mode.
	The power setting value under CP mode.
	The resistance setting value under CR mode.
	The voltage value and current value under CV+CC mode.
	The voltage value and current value under CV+CR mode.
	The current value and resistance value under CC+CR.
	The V, I, P, R setting value under CV+CC+CP+CR mode.
	The voltage setting value under Battery Sim. mode.
Config Menu	Run mode
	The status of Von function, mode and level.

You can do the save and recall operations by the following two methods.

- Press the composite keys **[Shift]+**  (Save) to save the parameters.
Press the composite keys **[Shift]+**  (Recall) to recall the parameters.
- Long press  to save the parameters, and long press the  to recall the parameters.
- SCPI commands : *SAV and *RCL



Save Operation

1. Press composite keys **[Shift]+**  (Save) or long press  to enter the save parameter interface.

Save File = 1

2. Rotate the knob to enter the number 1 to 10 and set the storage location, press **[Enter]** to save.

Recall Operation

1. Press the composite keys **[Shift]+**  (Recall) or long press  to enter the recall parameter interface.

Recall File = 1
12.000V 10.000A

description:

- first line: display the location of parameter.
 - second line: display the value of parameter. these parameters are different under different mode. The above example takes CC priority as example.
2. Rotate the knob and enter the number 1 to 10 and set the recall location, press **[Enter]** to recall the parameters.

7.3 Local/Remote Mode Switch

The instrument provides both local and remote operation modes. The default mode is local operation mode.

- Local operation mode: Use the front panel keys to control the power system.
- Remote operation mode: The power system is connected to PC, and the user uses the software in PC to control the power system remotely. During remote control operation, the remote symbol “Rmt” is displayed. All panel keys, except for the **[On/Off]** and **[Shift]+[Link]**(Local) keys are locked. You can press **[Shift]+[Link]**(Local) to switch the remote control to local control. The mode modification will not affect the output parameters of the power system.

7.4 Basic Operation

This chapter describes the basic functions and features of the instrument. Divided into the following sections:

7.4.1 Set the Beeper Status

The user can turn the instrument beeper sound on or off according to personal requirement.

- On status: A beeper sound produced when the front panel key is pressed. Default status is on.
- Off status: The beeper is disabled.

Operation procedures:

1. Press the composite keys **[Shift]+[P-Set]**(System) to enter the System menu interface.
2. Rotate the knob to select **Beep** and press **[Enter]** to confirm.
3. Rotate the knob to select **On** or **Off** and press **[Enter]** to confirm.
4. Press **[Esc]** to exit menu interface.

At this point, the beeper status takes effect immediately.

7.4.2 Set the Power-on State

This menu item is used to control the settings and output state when the power system is powered on. The detailed power-on parameters and output state are as follows.

- The run mode of instrument and setting value.
- The output state of the power system, i.e., the **[On/Off]** key state.

Operation procedures:

1. Press the composite keys **[Shift]+[P-Set]**(System) to enter System menu interface.
2. Rotate the knob to select **PowerOn** and press **[Enter]** to confirm.
3. Rotate the knob to set the power on state and press **[Enter]** to confirm.
 - Reset: default value, indicates when the instrument is powered on, the instrument will initialize the *RST setting.
 - Last: indicates when powered on, the instrument will remain the same settings and output state as last time you turned off.
 - Last+Off: indicates when powered on, the instrument will remain the same settings as last time you turned off, but the output state is OFF state.
4. Press **[Esc]** to exit menu interface.

7.4.3 Set the Sense Function State

This menu item is used to switch the instrument to local sensing or remote sensing. This series instrument support two connection methods: Local sensing and Remote sensing. The remote sensing is used for maximizing measurement accuracy. (Refer to [2.5 Connecting the Device Under Test \(DUT\)](#) for more information). The procedures to set the menu item are as follows.

1. Press the composite keys **[Shift]+[P-Set]**(System) to enter the System menu interface.
2. Rotate the knob to select **Sense** and press **[Enter]** to confirm.
3. Rotate the knob to select **On** or **Off** and press **[Enter]** to confirm.
 - Off: default value, indicates turn the sense function off.
 - On: indicates turn the sense function on.
4. Press the **[Esc]** key to exit.

7.4.4 Set the Communication Information

This menu item is used to set the communication information between instrument and PC. There is no standard communication interfaces for this

series instrument. You can select GPIB, USB, RS-485, RS-232, CAN or LAN interface based on personal requirement.

1. Press the composite keys **[Shift]+[P-Set]**(System) to enter the System menu interface.
2. Rotate the knob to select **I/O Config** and press **[Enter]** to confirm.
3. Rotate the knob to select the communication interface and press **[Enter]** to confirm, and also set the parameters of interface.

Please refer to [2.6 Connect the Communication Interface](#) for the detailed description of each communication interface parameter.

4. Press **[Esc]** key to exit.

7.4.5 Select Trigger Source

This series Power supply supports the following trigger sources:

- KeyPad: Default value, Select the front panel **[Shift]+[On/Off]** (Trigger) button as the trigger source.
- Bus: Select the remote interface command as the trigger source, such as the ***TRG** command.

The procedures to set the menu item are as follows.

1. Press **[Shift]+[P-set]** (System) to enter the system menu interface.
2. Use left and right keys or rotate the knob to select **Trig Source** and press **[Enter]** to make the parameter in modification.
3. Rotate the knob to adjust the parameter KeyPad or Bus and press **[Enter]**.

7.4.6 Restore the Factory Default Settings

This menu item is used to restore the factory default settings. The procedures to set the menu item are as follows.

1. Press **[Shift]+[P-set]**(System) to enter the System menu interface.
2. Rotate the knob to select **System Reset** and press **[Enter]**.
3. Rotate the knob to select **Yes** or **No** and press **[Enter]** to confirm.
 - No: default value, indicates cancels this menu setting.
 - Yes: indicates the instrument restores the factory default settings.

Table 7–1 Default parameters table

Parameter	Default Value
Config Menu	
Mode	CV Priority
V-Rise Time	0.01S
V-Fall Time	0.01S
I-Rise Time	0.01S
I-Fall Time	0.01S
On Delay	0.000S
Off Delay	0.000S
Output R	0.0mΩ
System Menu	
Beep	On
PowerOn	Reset
Sense	Off
I/O Config	Different status in different selected accessories
Parallel Mode	Single
Parallel Slave Group	A
Parallel Master Group	A
Parallel Master Total	1
Link Mode	On/Off
Link Track Reference	1
Ext Prog	Off
Chan Number	1
Protect Menu	
OVP Mode	Off
OVP Level	Max
OVP Delay	10.00S
OCP Mode	Off

Parameter	Default Value
OCP Level	Max
OCP Dealy	10.00S
OPP Mode	Off
OPP Level	Max
OPP Delay	10.00S
UVP Mode	Off
UVP Level	0.00V
UVP Delay	10.00S
UVP Warm	30.00S
UCP Mode	Off
UCP Level	0.000A
UCP Delay	10.00S
UCP Warm	30.00S

7.4.7 Observe the DUT Temperature and Total Historical Regenerative Power

This series instrument supports measuring DUT temperature and total historical regenerative power. User can observe the information under the system menu, and also the user can set the menu to display the information on the home screen. The procedure as following:

1. Press the composite keys **[Shift]+[P-set]**(System) to enter the System menu.
2. Rotate the knob to select **Ext-Meter Disp** and press **[Enter]** to confirm.
3. Rotate the knob to select **On** or **Off** and press **[Enter]** to confirm.
4. Press **[Esc]** to exit. the home screen as below.

```

12.000V    10.000A
 38.0°C    1000.0Wh
    
```



Note

User can press the V-set and I-set and set voltage and current value, and the instrument will return to the home screen automatically after activity on the front panel has ceased.

7.4.8 View the System Information

This menu item is used to view the system information of the instrument. The procedures to view the system information are as follows.

1. Press composite keys **[Shift]+[P-Set]**(System) to enter the System menu.
2. Rotate the knob to select **System Info** and press **[Enter]** to confirm.
3. Rotate the knob and view the system information.

Name	Description
Model	The instrument model
ArmVer	The control board version
InvDspVer	The DSP version
FpgaVer	The Fpga version
CommVer	The communication board version
SN	The serial number
Mac	The firmware address
Last Cal	Last calibration date
Start Time	Instrument running time

4. Press **[Esc]** to exit.

7.5 Measuring the DUT Temperature

This series instrument features temperature measuring terminals (Temp, GND), is used to measure the DUT temperature. The operation procedures as following:

1. Connecting the test line
 - a. Loosen the screws of the measuring temperature terminals, and insert the thermistor (IT-E1203). Re-tighten the screws.
 - b. Connecting the other end of thermistor to DUT.
2. Observe the information
 - a. Press the composite keys **[Shift]+[P-set]**(System) to enter the system menu.
 - b. Rotate the knob to select the **External Meter** and press **[Enter]** to confirm.
 - c. The DUT temperature and total historical regenerative power are displayed on screen.

1 : UUT Temp

2 : Re-Energy
 3 : AHour
 4 : WHour
 5 : Reset Meas
 6 : Reset ReE

- UUT Temp: temperature measurement value.
- Re-Energy: the regenerative power information.
- AHour: the capacity information of the present discharge or charge test, which is also cleared when the battery test mode or battery simulation mode is turned on.
- WHour: the power statistics information, when the battery test mode or battery simulation mode is turned on, the data will also be cleared.
- Reset Meas: The zero-clearing operation, when the instrument is re-powered or the source /load is switched it will be also performed.
- Reset ReE: The zero-clearing regenerative power information operation.

d. Press **[Esc]** to exit.

The information will display on the home screen when the Ext-Meter Disp set to On in system menu, the operation refers to [7.4.7 Observe the DUT Temperature and Total Historical Regenerative Power](#).

```

12.000V    10.000A
38.0°C     1000.0Wh
    
```

7.6 Observe the Regenerative power and Capacity

User can observe the total historical regenerative power and capacity information on screen.

1. Press the composite keys **[Shift]+[P-set]**(System) to enter the system menu.
2. Rotate the knob to select the **External Meter** and press **[Enter]** to confirm.
3. The DUT temperature, total historical regenerative power and capacity are displayed on screen.

1 : UUT Temp
 2 : Re-Energy
 3 : AHour
 4 : WHour
 5 : Reset Meas
 6 : Reset ReE

- UUT Temp: indicates the DUT temperature.

- Re-Energy: indicates the regenerative power.
 - AHour: indicates the capacity of charge and discharge, when the battery simulator function or battery test function is enabled, the capacity data will be cleared.
 - WHour: indicates energy data, when the battery simulator function or battery test function is enabled, the energy data will be cleared.
 - Reset Meas: clearing the energy data and capacity data.
 - Reset ReE: clearing the regenerative power data.
4. Press **[Esc]** to exit.

7.7 External analog function (optional)

When the interface card selected by the user is DB25 analog interface (IT-E1208), the analog interface can realize the external analog function.

The rear panel of this series is optionally configured with a DB25 analog interface, through which, the following functions can be realized:

- Remotely control voltage and current values
- Control On/Off state
- Remotely monitor CC and CV states as well as voltage and current values
- Clear instrument faults
- Monitor the instrument loading state, On/Off state and fault state
- RS-485 interface connection. For detailed introduction about interface, refer to [2.6.5 RS-485 Interface](#)

CAUTION

- **Before connecting the hardware equipment that controls the analog interface, ensure that the hardware equipment would not output voltage that is 20% higher than specified value. Otherwise, it would damage the instrument. For example, during setting of voltage or current, the input voltage cannot exceed 12V. Otherwise, it would damage the instrument.**
- **Under the analog remote control mode, the analog signal input pin cannot be suspended, before enabling the external analog function on the front panel, it is necessary to correctly connect the 1 (Vol_Pro), 15 (Cur_Pro) and 17 (Cur/Vol_Pro).**
- **There is safe electrical isolation between the analog interface and the DC terminal. Do not connect any ground wire of the analog interface to the DC+ or DC- terminal on the instrument's rear panel.**

The analog signal bandwidth is less than 100Hz, and the signal bandwidth supports any waveform. When the programmed signal frequency or amplitude exceeds the output capacity, the instrument will automatically limit the output amplitude. When the input voltage exceeds 10V, the set value will be limited in the maximum rated value range.

Figure 7–1 DB25 analog interface

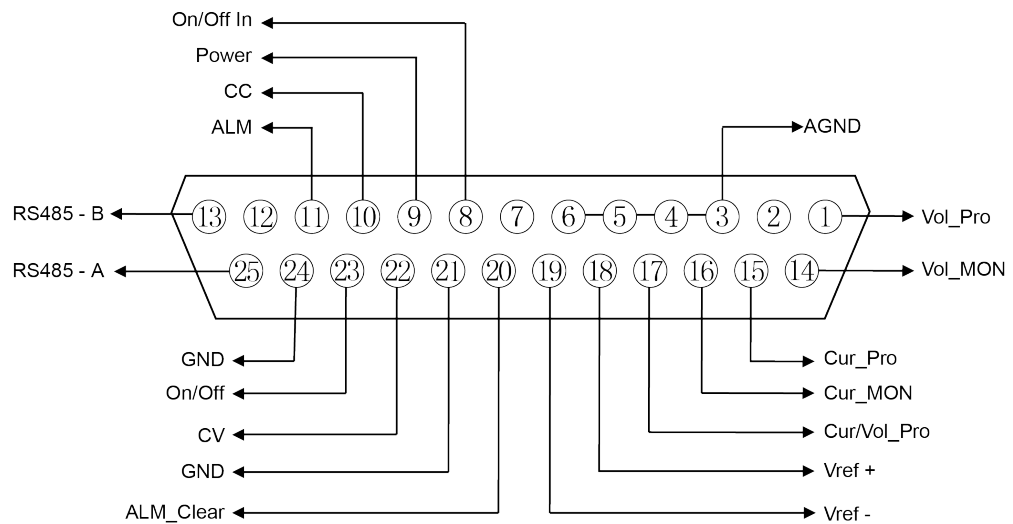

Table 7–2 DB25 analog interface description

Pin	Name	Type	Description
1	Vol_Pro	Analog input	<ul style="list-style-type: none"> When CV is prioritized, input 0 – 10V voltage value to set the output voltage between 0 and full scale; When CC is prioritized, input 0 – 10V voltage value to set the low voltage limit (V_low value) between 0 and full scale;
3–6	AGND	Grounding of analog signal	Grounding of all analog signals, including pins: 1 (Vol_Pro), 14 (Vol_MON), 15 (Cur_Pro), 16 (Cur_MON), 17 (Cur/Vol_Pro), 18 (Vref+) and 19 (Vref-).
2, 7, 12	Unused	–	–
8	On/Off_In	Digital input	Control the On/Off state of the instrument. When 0V is input, the instrument state is switched to Off; when 5V is

Pin	Name	Type	Description
			input, the instrument state is switched to On.
9	Power	Digital output	Indicate the instrument's loading state: Under normal loading state, 5V is output; under non-loading state, 0V is output.
10	CC	Digital output	Indicate the instrument's working state: Under the CC mode, 5V is output; otherwise, 0V is output.
11	ALM	Digital output	Indicate the instrument's fault state: If the instrument is normal, 5V is output; if the instrument is abnormal, 0V is output.
13, 25	RS485-A, RS485-B	Communication terminal	RS485 interface connection terminal.
14	Vol_MON	Analog output	Monitor the voltage, and output 0 ~ 10V voltage value to monitor the DC terminal voltage between 0 and full scale.
15	Cur_Pro	Analog input	set current. The input range varies under different modes. <ul style="list-style-type: none"> • When CV is prioritized, input 0 ~ 10V voltage value to set the negative current limit (I_Lim- value) between 0 and negative full scale; • When CC is prioritized, input -10V ~ 10V voltage value to set the current value between negative full range and positive full scale;
16	Cur_MON	Analog output	Monitor current. The output range varies under different modes. <ul style="list-style-type: none"> • output -10V ~ 10V voltage value to monitor the output or absorption current between negative full range and positive full scale;

Pin	Name	Type	Description
17	Cur/Vol_Pro	Analog input	Under the source mode, the multiplexer terminal is controlled by current/voltage setting: <ul style="list-style-type: none"> • When CV is prioritized, input 0 ~ 10V voltage value to set the positive current limit (I_Lim+ value) between 0 and full scale; • When CC is prioritized, input 0 ~ 10V voltage value to set the high voltage limit (V_High value) between 0 and full scale;
18	Vref+	Analog output	The 10V reference voltage output by the instrument can be connected to a resistive subdivision for analog control.
19	Vref-	Analog output	The -10V reference voltage output by the instrument can be connected to a resistive subdivision for analog control.
20	ALM_Clear	Digital input	Clear instrument faults: When 5V is input, clear fault; when 0V is input, do not clear fault.
21, 24	GND	Grounding	Grounding of all digital signals, including pins: 8 (On/Off_In), 9 (Power), 10 (CC), 11 (ALM), 20 (ALM_Clear), 22 (CV), 23 (On/Off)
22	CV	Digital output	Indicate the instrument's working state: Under the CV mode, this pin outputs 5V; otherwise, this pin outputs 0V.
23	On/Off	Digital output	Indicate the instrument's On/Off state: When the instrument is On, this pin outputs 5V; when the instrument is Off, this pin outputs 0V.

Enable/disable analog control

1. Press **[Shift]+[P-Set]**(System) composite key, and enter the System menu interface.
2. Rotate the knob, select **I/O Config**, and press **[Enter]** key for confirmation.

The related configuration menus can be displayed only when the user selects the analog interface.

3. Rotate the knob, select **Ext_Program**, and press **[Enter]** key for confirmation.
4. Rotate the knob, and switch the display of **On** and **Off** options. After selecting **On**, press **[Enter]** key for confirmation.
 - Off: Default value, indicating that this function is turned off.
 - On: Indicating that the function is turned on. Before turning on the external analog interface function, please confirm whether pins 1 (Vol_Pro), 15 (Cur_Pro) and 17 (Cur/Vol_Pro) are correctly connected.
5. Press **[Esc]** key, and exit the menu interface.

Analog interface remote control

Through the analog input interface, the analog signal can be input to remotely set the output voltage value or current value. For detailed function definition of pin, refer to [Table 7–2 DB25 analog interface description](#). The text below introduces the wiring and usage method taking the common On/Off control and voltage and current control as examples.

When the voltage and current setting values are controlled through the analog interface, connect the external voltage (0V ~ 10V) to program the voltage or current value between 0 and full range. Meanwhile, the analog monitoring function (0V ~ 10V) can be used to monitor the existing voltage or current between 0 and full range. During parallel operation, the master unit analog interface can be used to program or monitor the voltage and current for programming of 0V ~ 10V and monitoring of voltage or current value between 0V and parallel full range.

For example, the analog controls the current with range of 0 ~ 80A. When the analog signal voltage is set to 5V, the instrument's output or input voltage is set to 40A; when the analog signal voltage is set to 8V, the instrument's output or input voltage is set to 64A.

Voltage and current setting

- CV priority mode
 - Voltage setting: Connect an external DC power supply capable of outputting 0V ~ 10V between pin 1 (Vol_Pro) and pin 3/4/5/6 (AGND) of the analog interface.
 - Positive current limit setting (I_Lim+): Connect an external DC power supply capable of outputting 0V ~ 10V between pin 17 (Cur/Vol_Pro) and pin 3/4/5/6 (AGND) of the analog interface.

- Negative current limit setting (I_Lim-): Connect an external DC power supply capable of outputting 0V ~ 10V between pin 15 (Cur_Pro) and pin 3/4/5/6 (AGND) of the analog interface.
- CC priority mode
 - Current setting: Connect an external DC power supply capable of outputting –10V ~ 10V between pin 15 (Cur_Pro) and pin 3/4/5/6 (AGND) of the analog interface.
 - High voltage limit (V_High): Connect an external DC power supply capable of outputting 0V ~ 10V between pin 17 (Cur/Vol_Pro) and pin 3/4/5/6 (AGND) of the analog interface.
 - Low voltage limit (V_Low): Connect an external DC power supply capable of outputting 0V ~ 10V between pin 1 (Vol_Pro) and pin 3/4/5/6 (AGND) of the analog interface.

The wiring method is as follows.

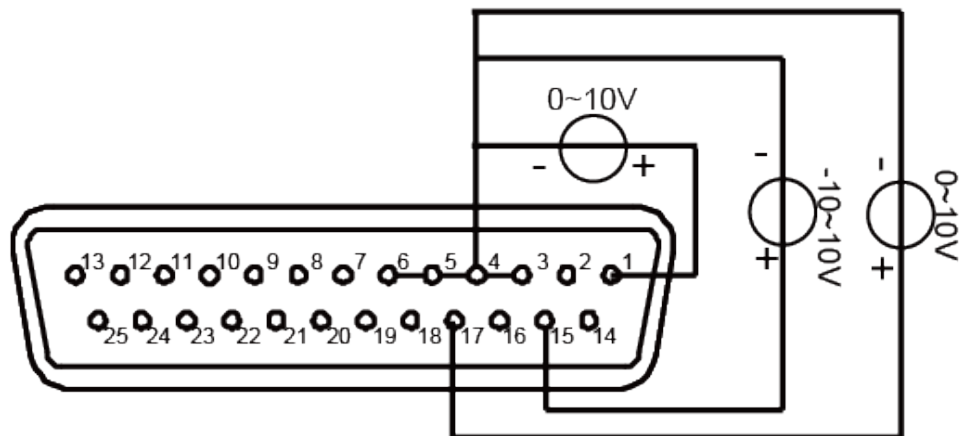

- Switch of On/Off state

The On/Off state can be switched remotely through the analog interface. Connect an external DC power supply capable of outputting 0V and 5V between pin 8 (On/Off_In) and 21 (GND) of the analog interface. Other analog input pins should also be connected correctly. The wiring method is shown in the figure below.

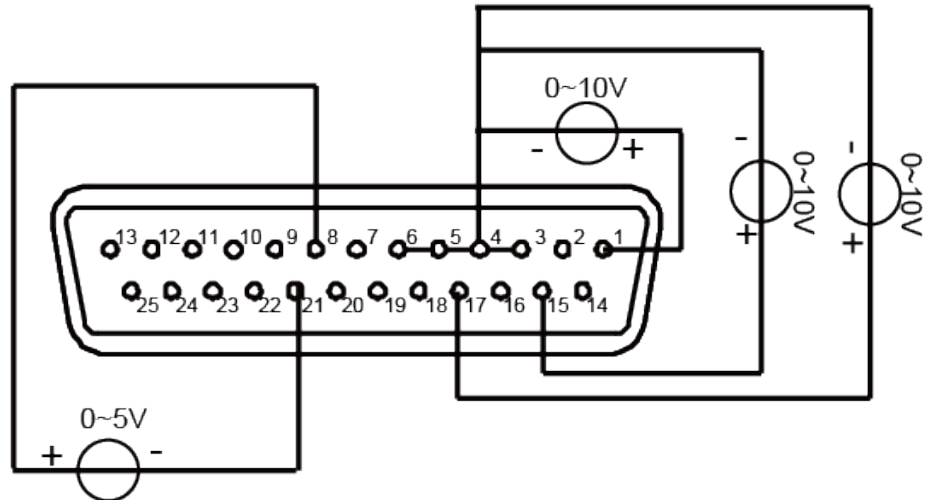

When 0V is input, the instrument's On/Off state is switched to Off state.
 When 5V is input, the instrument's On/Off state is switched to On state.

- Voltage and current monitoring

Through the analog interface, the existing output voltage/current or input voltage/current can be monitored. Connect a digital voltmeter between pin 14 (Vol_MON), pin 16 (Cur_MOM) and ground wire 3/4/5/6 (AGND) of the analog interface. Other analog input pins should also be connected correctly. The wiring method is shown in the figure below. The 0 ~ 10V voltage reading corresponds to the power/load voltage and current output/input between zero and full scale. The wiring diagram is shown in the figure below.

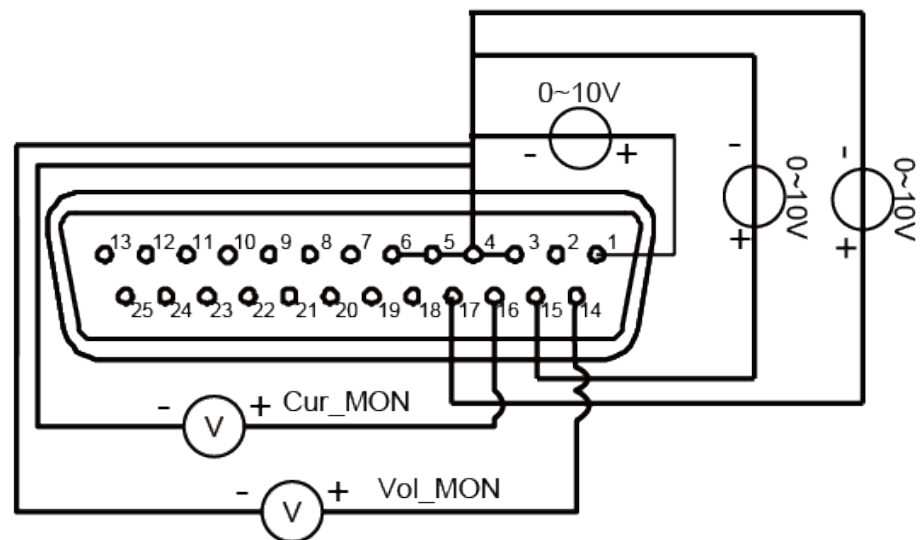

7.8 Anti-reverse connection module function (optional)

When the user connects the battery and executes the battery charge and discharge test, select the IT-E118 anti-reverse connection module to realize DC reverse connection protection, surge suppress, and sense reverse connection protection.

The output terminal on the rear panel of series instrument can be optionally configured with IT-E118 anti-reverse connection module, which can realize the following functions:

- Anti-reverse connection of the DC output terminal
- Isolated from the wiring of the energy-storage DUT
- Surge suppress
- Sense reverse connection protection

The dimension figure of the IT-E118 anti-reverse connection module is as follows:

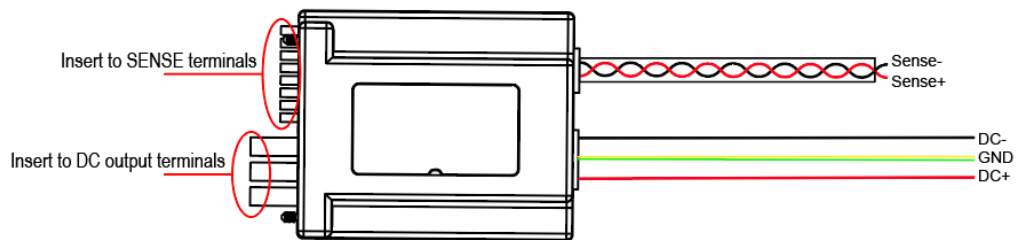

Wiring method:

Insert one end of the anti-reverse connection module to the DC output terminal and sense terminal of the instrument rear panel, and connect the other end to the test line of the DUT. Introduction of the wiring method:

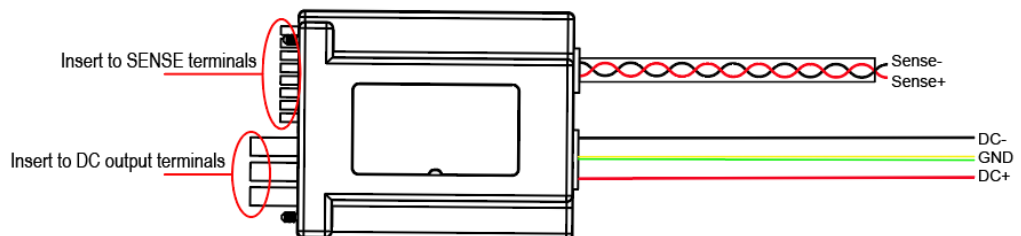

Note

By default, the DC+/DC- and Sense test lines are not of standard configuration during ex-factory. Please make selection based on the test line specifications. A set of Sense test line specifications: AWG22-600V; A set of DC+/DC- test line specifications: AWG12-600V

Usage method:

After the instrument is connected to the anti-reverse connection module, the instrument automatically detects the module connection state; if the connection is succeeded, the SDS module setting in the system menu is defaulted as Enable, and the anti-reverse connection module is under enabled state. Based on the user operating state, the module state requirements are as follows:

- When the user conducts common test instead of battery charge/discharge function, turn on the output, and the instrument panel prompts “SDS Enabled”. The user needs to set corresponding state of SDS in the system menu and set the SDS module to Disable state. Otherwise, the instrument output cannot be turned on.
- When the user enters the battery charge/discharge mode (Function > Battery), the instrument automatically sets the anti-reverse connection module SDS in the system menu to Enable state. Under this state, the anti-reverse connection module can be disabled through manual or command mode.

After the anti-reverse connection module is connected, the user needs to connect the remote measure terminal SENSE+/SENSE-; when the battery charge/discharge test function (Function > Battery) is executed, the instrument automatically sets Sense to On state in the system menu and detects the SENSE state; if the connection fails or there is any abnormality, report the protection prompt that SENSE fails to detect voltage. Press [Esc] to exit.

Prompt information for reverse connection protection. All prompt interfaces can be exited by pressing the [Esc] key.

- No SDS Module detected: Under the battery charge/discharge mode, if the prompt is given when the On/Off key on the front panel is pressed and SDS is not inserted, the user can select to continue the execution or detection of SDS module.
- DC Port No Voltage: The prompt is given in the case of reverse connection or abnormality at the DC terminal.
- Sense Port No Voltage: The prompt is given in the case of reverse connection or abnormality at the Sense terminal.
- Surge Suppressing: The prompt is given when the surge suppress is operated with command or when a battery with certain voltage is correctly connected for surge suppress under the battery test mode.
- Surge Suppress Done: The prompt is given when the surge suppress operation is succeeded.
- Surge Suppress Fail: The prompt is given when the surge suppress operation is failed.

- Error: Module conflict: When the user attempts to connect several machines in parallel, if any two machines are of not same models, the master unit would give prompt until all modules are consistent. During this period, the output and input cannot be turned on by the master unit, and the power and load modes cannot be switched. However, the user can enter the System menu to configure related parameters.

8 Multi-Machine Operation

- ◆ Multi-Channel Function
- ◆ Synchronized Function (Link)

WARNING

SHOCK HAZARD. All paralleled units must be connected to ground through a grounded power cord at all times. Any interruption of the protective (grounding) conductor or disconnection of the protective earth terminal on any unit will cause a potential shock hazard that could result in injury or death.

Type	Introduction	Maximum Quantity	Model Restriction
Multi-channel	The operation can be realized by the PC control software IT9000. By communicating one unit in the System Bus link with the PC, it is possible to independently control any other unit in the PC software.	A maximum of 16 units can be connected in each System Bus link.	Multi-channel systems can be composed of single units of the same series and different models.
Synchronization	By operating one unit in the System Bus link locally or remotely, it is possible to synchronously control the On/Off and equal-scale output of the other units.	A maximum of 16 units can be connected in each System Bus link.	Synchronization systems can be composed of single units of the same series and different models.

Function Introduction

The multi-machine operation refers to connecting multiple instruments according to a fixed wiring mode through the System Bus interface to realize multichannel, parallel, and synchronous control functions. Multi-channel systems can be composed of single units of the same series and different models. The following is a general introduction to these three functions:

- Multi-channel operation:

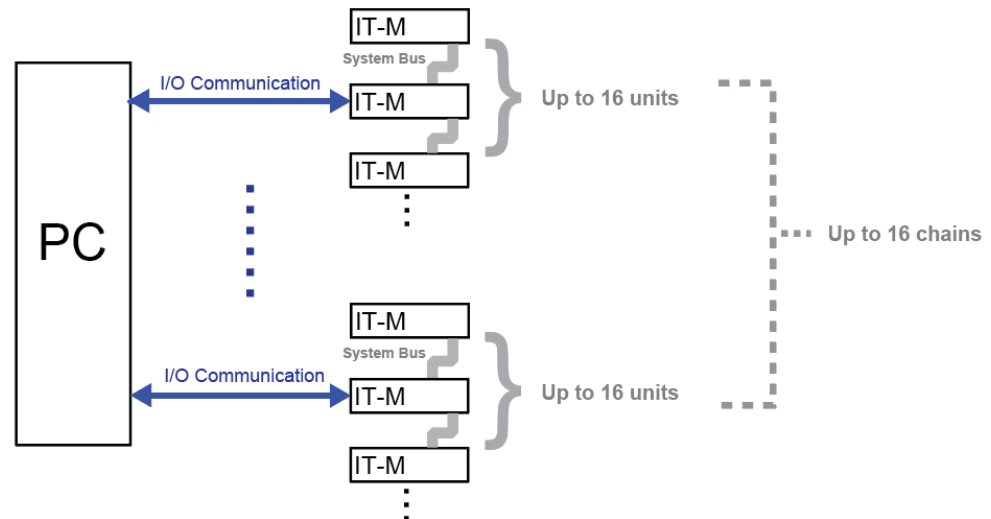

- Synchronization operation:

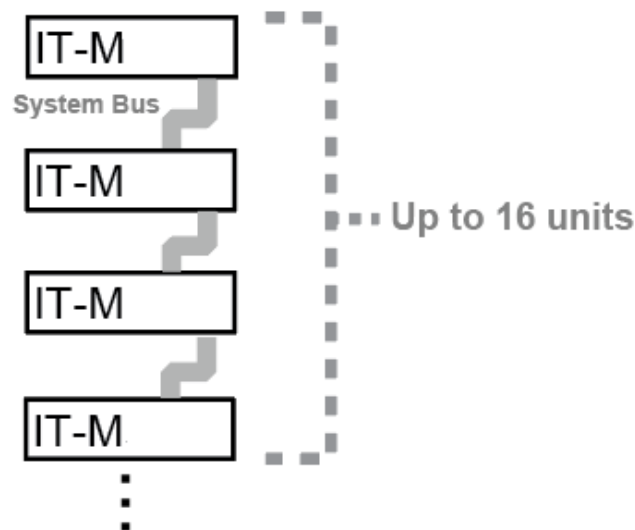

8.1 Multi-Channel Function

For multi-channel operation controlled by the PC software, the user will need to install one communication card only into one of the multiples units, and other instruments are connected with the PC through a multi-channel connection with system bus. The cost of the communication cards is saved, and the connection interface on the PC side is also reduced. When using the multi-channel function, the instruments in the channels do not require the same model, and all models in the same series can form a multi-channel power system. Up to 16 * 16 channels, each instrument in the control system can be controlled independently in software, and each channel can be operated completely independently.

When multiple power supplies are connected through the System Bus interface, each power supply must be set to a separate channel number ranging from 1 to 16. The power supply connected to the same system bus, the channel number can not be repeated, otherwise it will cause conflicts. All power interfaces will prompt “Chan Number Conflict”. In this case, rotate the knob to change the channel number directly, press **[Enter]** to confirm.

The following three instruments are taken as an example to describe the connection and operation steps of multiple channels.

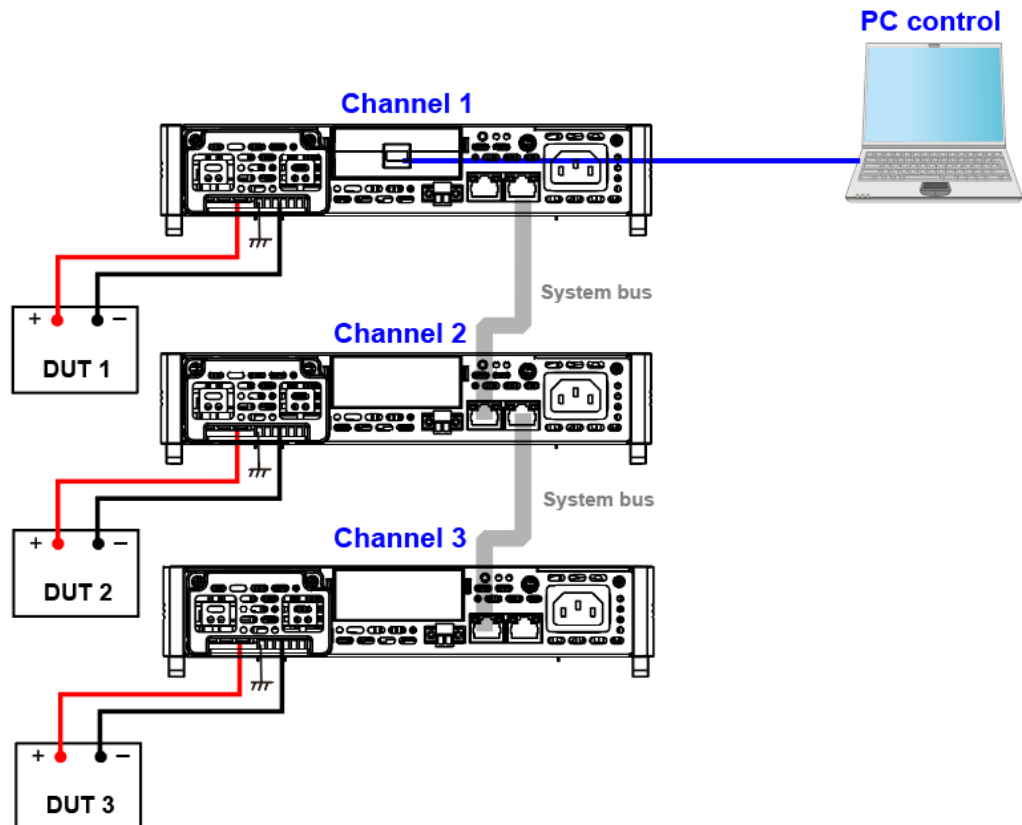

The procedures to set the multiple channels are as follows.

1. Set the channel number for each instrument.
 - a. Press the **[Shift]+[P-set]** (System) composite keys to enter the system menu interface.
 - b. Use left and right keys or rotate the knob to select **Channel Number** and press **[Enter]** key to make the parameter in modification.
 - c. Rotate the knob to adjust the value and set the channel number, the setting range is between 0–16. Press **[Enter]** to confirm.
 - d. Repeat steps a through c to set the channel number for other instrument.
2. Connect the instruments according to the above diagram. Please disconnect the power before wiring.

- a. Connect system bus interfaces.
 - b. Connect the DUTs. Refer to [2.5 Connecting the Device Under Test \(DUT\)](#) for more information about connection methods.
 - c. Connect the instrument to PC. refer to [2.6 Connect the Communication Interface](#).
3. After power-on, if the interface prompts “Chan Number Conflict”, rotate the knob to change the channel number directly.

8.2 Synchronized Function (Link)

By operating one unit in the System Bus link locally or remotely, it is possible to synchronously control the On/Off and equal-scale output of the other units. The synchronization function and On / Off Delay function can be used together to realize the application of timing output.



Note

Before configuring the synchronized function, each instrument must be set to a separate channel number ranging from 1 to 16. refer to [8.1 Multi-Channel Function](#) .

There are three synchronized modes as follows:

- **On/Off Only**: set multiple units to output on/off and Save/Recall synchronization.
- **Track**: besides output on/off and Save/Recall synchronization, you can set the voltage proportional relation **Reference** among multiple power supplies to make the voltage change proportionally. For example, set the voltage proportional relation for three power supplies to 3, 4 and 5. If the voltage of the first power supply is set to 30 V, the voltage of the other two power supplies will change to 40 V and 50 V automatically.



Note

This function requires multiple instruments to be in CV priority mode at the same time, otherwise the voltage setting proportionally is not effective. Before using this function set all units to CV priority mode.

- **Duplicate**: in this mode, the synchronized operations includes: output on/off synchronization, voltage/current setting value changing synchronization, Save/Recall synchronization, priority mode synchronization, voltage/current rising/falling synchronization and Protect menu function synchronization.

There are the following two synchronized status:

- **Online:** indicates the instrument is in the synchronized relationship. At this time, the front panel **[Link]** key light is lit.
- **Offline:** indicates the instrument is not in the synchronized relationship and the front panel **[Link]** key light is off.

You can enter into the system menu to set the status(Online/Offline) of the instrument, or you can short press (1 s or so) the front panel **[Link]** key to switch the synchronization status of the instrument. Long pressing (about 3 s) **[Link]** key can display the current synchronization status of the instrument. At this time, pressing **[Enter]** key can enter into the synchronization menu setting interface. You can set parameters such as synchronized mode or On/Off delay time.

Take the synchronized relationship among single instrument and multiple parallel groups for instance, the detailed connection method and procedures are as follows.

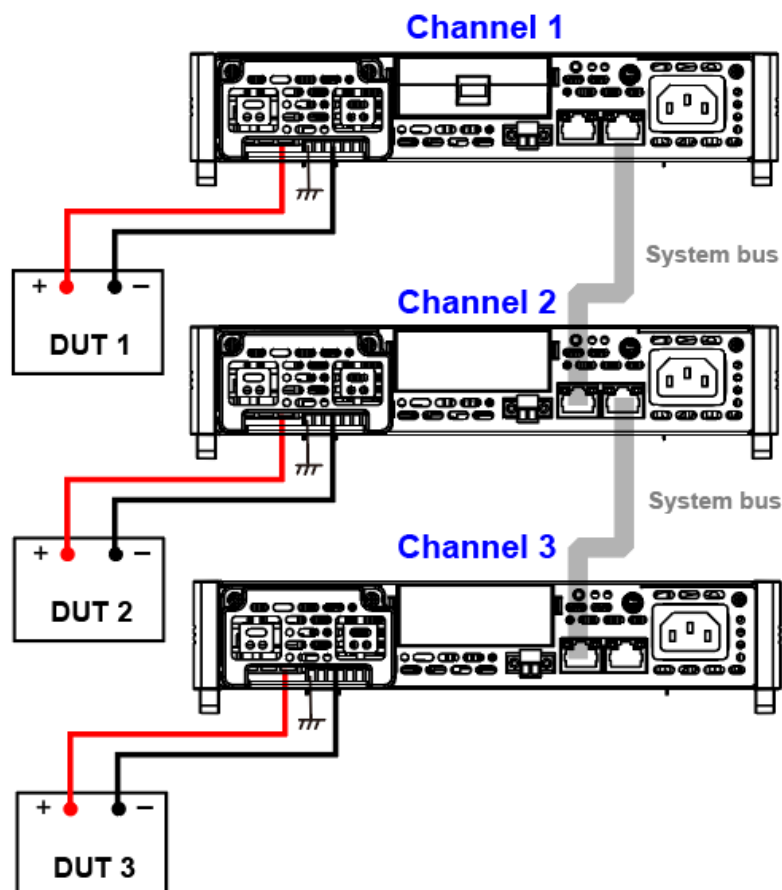

1. Configure the channel number of each instrument. Please refer to [8.1 Multi-Channel Function](#) for detailed introduction.
2. Connect the instruments according to the above diagram.
 - a. Connect system bus interfaces.

- b. Connect the DUTs. Refer to [2.5 Connecting the Device Under Test \(DUT\)](#) for more information about connection methods.
 3. Turn on the **Link** switch of each instrument in turns.
 - a. Press **[Shift]+[P-set]** (System) to enter into the system menu interface.
 - b. Use left and right keys or rotate the knob to select **Link** and press **[Enter]** key to make the parameter in modification.
 - c. Rotate the knob to set **Status** and press **[Enter]** key to confirm.
 - **Online**: indicates the instrument is in the synchronized relationship.
 - **Offline**: indicates the instrument is not in the synchronized relationship.
 - d. Rotate the knob to set **Mode** and press **[Enter]** key to confirm.
 - **OnOff Only**
 - **Track→Reference**
 - **Duplicate**

9 Parallel Function (Parallel)

Parallel operation allows the user to connect multiple power supplies simultaneously to create a system with higher total current and power. Each parallel system (group) supports up to 16 single units (1 master and 15 slaves) for parallel connection. Power and current expand 16 times.

In parallel connection system, the master instrument needs to be set group number, the group number range is between A to H, and the slave instrument needs to set the master group number that slave belongs to. In each group, one instrument must be the master unit and all other instruments connected in parallel are slave units. All features are set up from the master unit.

Each parallel system (group) supports up to four single units (1 master and 3 slaves) for parallel connection. Each system bus link can connect up to 16 single units and support up to 16 parallel systems (groups). The units models in each parallel system (group) must be the same. Multi-channel or synchronization systems can be composed of multiple parallel systems (-groups) on a System Bus link, and the units in Group A and Group B can be the same series but different models.

In parallel mode, the Sink power function is valid in CC mode.

Configure One Group

Take three power supplies for instance, set them to one master unit and two slave units. The detailed connection method and procedures are as follows.



Note

In the parallel system, the master unit executes all features, but you need to connect all units output terminals to DUT due to the output terminals of a single unit can not deliver higher rated current.

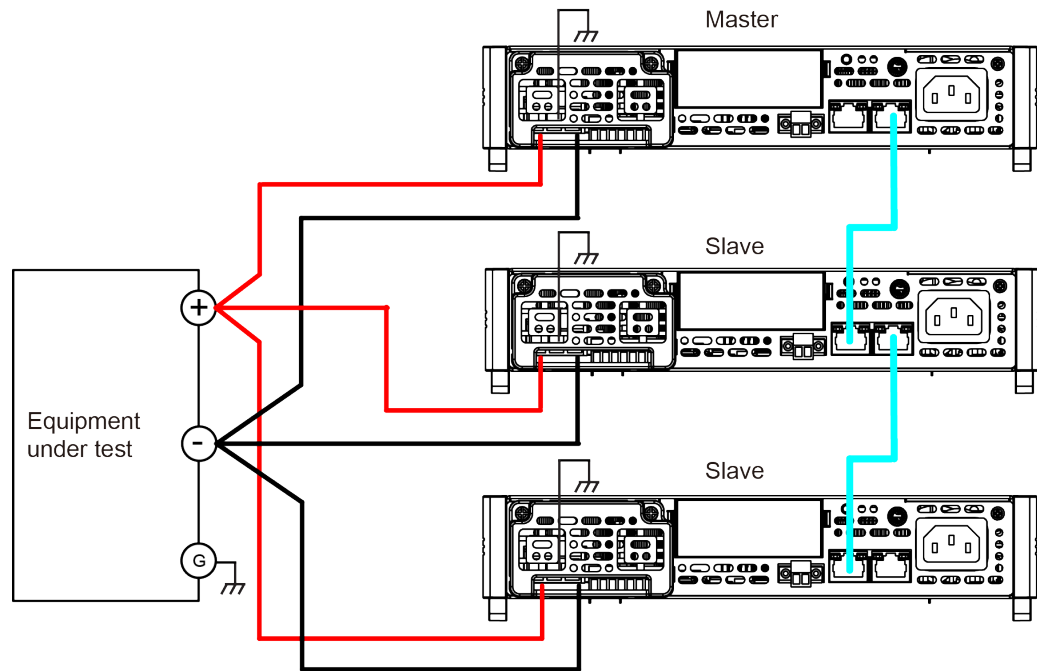

1. Configure the channel number of each instrument. Please refer to [8.1 Multi-Channel Function](#) for detailed introduction.
2. Connect the instruments according to the above diagram.
 - a. Connect system bus interfaces. Before connecting the system bus, be sure that the instrument is single mode.
 - b. Connect the DUTs. Refer to [2.5 Connecting the Device Under Test \(DUT\)](#) for more information about connection methods.
3. After finishing connection, configure one power supply as a master unit.
 - a. Press **[Shift]+[Save]** (System) composite keys to enter the system menu interface.
 - b. Use left and right keys or rotate the knob to select **Parallel** and press **[Enter]** key to make the parameter in modification.
 - c. Rotate the knob to select **Master** and press **[Enter]** key to confirm.
 - d. Set **Master group** to A and press **[Enter]** key to confirm.
 - e. Set **Master Total** to 3 and press **[Enter]** key to confirm.



Note

At this time the screen displays “Search Slave...”, it will return normally automatically after configuration.

4. Configure the remaining two units as slave units.
 - a. Press **[Shift]+[Save]** (System) composite keys to enter the system menu.
 - b. Use left and right keys or rotate the knob to select **Parallel** and press **[Enter]** key to make the parameter in modification.
 - c. Rotate the knob to select **Slave** and press **[Enter]** key to confirm.
 - d. Set **Slave group** to A and press **[Enter]** key to confirm.

5. After making the master-slave setting, the master unit will automatically restart to ensure normal operation, the current range will expand, the slave units display “Slave Mode Group-A” in screen.

To change Parallel Mode to Single Mode, follow the steps below:

1. Power off the instruments.
2. Remove System Bus among the instruments.
3. Power on the instruments.
4. Switch the instruments into single mode respectively.
 - a. Press **[Shift]+[P-set]** (System) composite keys to enter into the system menu interface.
 - b. Use left and right keys or rotate the knob to select **Parallel** and press **[Enter]** key to make the parameter in modification.
 - c. Rotate the knob to select **Single** and press **[Enter]** key to confirm.

Configure Three Groups

Take seven power supplies for instance, set them to three groups. Group A: one master unit and two slave units. Group B / C: one master unit and one slave unit. The detailed connection method and procedures are as follows.

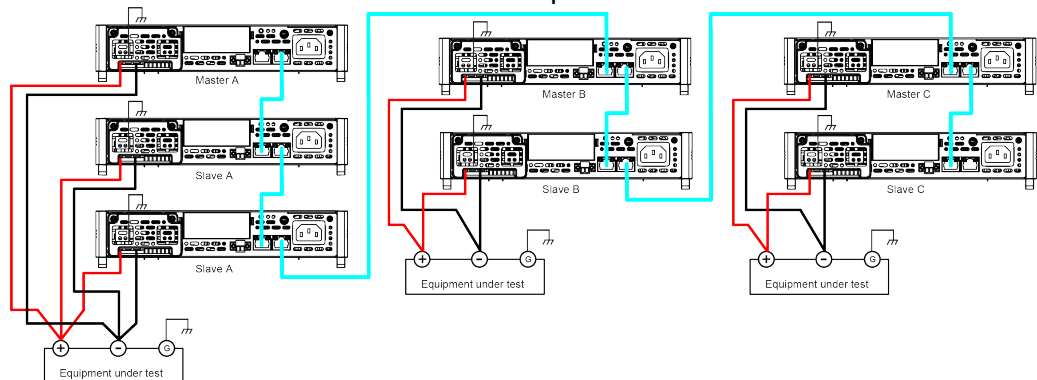

1. Configure the channel number of each instrument. Please refer to [8.1 Multi-Channel Function](#) for detailed introduction.
2. Connect the instruments according to the above diagram.
 - a. Connect system bus interfaces. Before connecting the system bus, be sure that the instrument is single mode.
 - b. Connect the DUTs. Refer to [2.5 Connecting the Device Under Test \(DUT\)](#) for more information about connection methods.
3. After finishing connection, configure one power supply as a master unit.
 - a. Press **[Shift]+[P-set]** (System) composite keys to enter into the system menu interface.
 - b. Use left and right keys or rotate the knob to select **Parallel** and press **[Enter]** key to make the parameter in modification.
 - c. Rotate the knob to select **Master** and press **[Enter]** key to confirm.
 - d. Set **Master group** to A and press **[Enter]** key to confirm.
 - e. Set **Master Total** to 3 and press **[Enter]** key to confirm.

- f. Repeat steps a through e for the other two master units. Set **Master group** to B and C. Set **Master Total** to 2 and 2.
4. Configure other units as slave units.
 - a. Press **[Shift]+[P-set]** (System) composite keys to enter into the system menu interface.
 - b. Use left and right keys or rotate the knob to select **Parallel** and press **[Enter]** key to make the parameter in modification.
 - c. Rotate the knob to select **Slave** and press **[Enter]** key to confirm.
 - d. Set **Slave group** to A and press **[Enter]** key to confirm.
 - e. Repeat steps a through d for the other slave units. Set **Slave group** to B and C.
5. After making the master-slave setting, the instrument will automatically restart to ensure normal operation.

Note

Multi-Master can compose Multi-Channel system. for detailed information refer to [8.1 Multi-Channel Function](#).

To change Parallel Mode to Single Mode, follow the steps below:

1. Power off the instruments.
2. Remove System Bus among the instruments.
3. Power on the instruments.
4. Switch the instruments into single mode respectively.
 - a. Press **[Shift]+[P-set]** (System) composite keys to enter into the system menu interface.
 - b. Use left and right keys or rotate the knob to select **Parallel** and press **[Enter]** key to make the parameter in modification.
 - c. Rotate the knob to select **Single** and press **[Enter]** key to confirm.

10 Routine Maintenance

This chapter describes the general maintenance items and maintenance methods of the IT-M series instrument.

- ◆ Instrument Self-Test
- ◆ Cleaning and Maintenance
- ◆ Information Reference
- ◆ Contact of ITECH Engineers
- ◆ Return for Repair

10.1 Instrument Self-Test

Self-test checks that the minimum set of logic and power mesh systems are functioning properly. Self-test does not enable the output or place any voltages on the output. Self-test can be achieved in two ways:

- Re-start the instrument. Each time the instrument is powered on, the self-test is performed. This test assumes that the instrument is running.
- SCPI command: *TST?. If the return value is 0, the self-test passes; if it is 1, the self-test fails. If the self-test fails, please send command **SYSTem:ERRor?** to view the self-test error. Please refer to *IT-M3400 Programming Guide* for the list of error codes.



Note

Ensure that all test cables connections are removed when self-test is performed. During self-test, errors may be induced by signals present on external wiring, such as long test leads that can act as antennae.

10.2 Cleaning and Maintenance

To ensure the safety function and performance of the instrument, please clean and maintain the instrument properly.

WARNING

- **To prevent electrical shock, disconnect the instrument from AC mains power and disconnect all test leads before cleaning.**
- **Do not use detergent or solvents.**
- **Do not disassemble the instrument and attempt to clean internally.**

Clean the outside and the front panel screen of the instrument using a soft, lint-free, cloth slightly dampened with water. Use a brush to clean the dust on the vent and cooling fans.

10.3 Information Reference

IT-M3400 has a detailed error and prompt information function, so as to help the user to easily carry out positioning and measurement during measurement and use.

Prompt Message List

Prompt information
Waiting for Trigger
The file is empty.
Over Current Protect
Over Power Protect
Over Voltage Protect
Under Current Protect
Under Voltage Protect
Sense Protect
Over Temp Protect
Line Drop Protect
Reverse Protect
Temp Sense Failure
Fan Failure
Power Down
Soft Wdog Protect
Undefine Prot
The Key Is Locked!
Remote Mode!
RWT Mode!
Save Successful
Save Failed

10.4 Contact of ITECH Engineers

This section describes operations to be carried out by the user in case of failure of the instrument.

Preparation before contact

When the instrument fails, you should make the following preparations before returning the instrument to ITECH for repair or contacting engineers.

- Check all the items listed in the [Self-inspection of equipment faults](#) and confirm whether there are still some problems.
- Collect the SN of the instrument.

If there are still some problems, carefully read the **Warranty** and **Limitation of Warranty** in the preface of the manual. Confirm that your instrument complies with warranty service conditions. If after your warranty expires, ITECH offers repair services at competitive prices.

Self-inspection of equipment faults

When the instrument fails, make the following checks to ensure that the failure is in the instrument rather than any external connections. If the instrument failure can be eliminated via simple inspection, the maintenance cost and time can be saved.

- Check whether the AC power cord is securely connected to the instrument and to a powered outlet.
- Check whether the front-panel Power On switch has been pushed.
- Check whether self-inspection of the instrument is successful and whether the specifications and performance are within the indicator ranges.
- Check whether the instrument displays error information.
- Use other instruments instead of this instrument for confirmation.

Collect the SN number

ITECH will constantly improve the product performance, availability and reliability. The service personnel of ITECH will record changes of each instrument. All relevant information is marked uniquely according to the serial number of each instrument. The equipment returned for repair must adopt the SN number as the tracking ID.

When you contact the engineer, the effective SN number of the instrument will be the effective guarantee for effective service and complete information. You can obtain the SN number of the instrument by the following ways:

1. Press **[Shift]+[P-Set]**(System) composite keys to enter into the system menu interface.
2. Use left and right keys or rotate the knob to select **System Info** and press **[Enter]** key.
3. Use left and right keys or knob to view the SN number.

Please record the SN number and provide SN information when doing maintenance service.

How to contact ITECH engineers

Access ITECH official website www.itechate.com or call the service number 4006-025-000 for technical support and services.

10.5 Return for Repair

If your instrument fails during the warranty period, ITECH will repair or replace it under the terms of your warranty. After your warranty expires, ITECH offers repair services at competitive prices. Also you can purchase an extended maintenance service contract that exceeds the standard warranty period.

Get Repair Service

To get the service for your instrument, choose the easiest way to contact the ITECH engineers. ITECH will arrange for repair or replacement of your instrument or provide warranty and repair cost information (if applicable).

Repackaging for Shipment

CAUTION

Never use styrene pellets in any shape as packaging materials. They do not adequately cushion the instrument or prevent it from shifting in the carton. Styrene pellets cause the instrument damage by generating static electricity and by lodging in the rear panel.

ITECH recommends that you retain the original shipping carton for return shipments and always insure shipments. To ship the unit to ITECH for service or repair:

1. Download the **ITECH maintenance service application** from our website, complete it and place it in the box with the instrument.
2. Place the unit in its original container with appropriate packaging material.

If the original shipping container is unavailable, use a container that will ensure at least 10 cm (4 in.) of compressible packaging material around the entire instrument. Use static-free packaging materials.

3. Secure the container with strong tape or metal bands.

11 Technical Specification

This chapter will introduce the main technical parameters of this instrument, such as rated voltage/current/power and so on. Besides, we will introduce the working environment and storage temperature.

- ◆ IT-M3412
- ◆ IT-M3422
- ◆ IT-M3432
- ◆ IT-M3413
- ◆ IT-M3423
- ◆ IT-M3433
- ◆ IT-M3414
- ◆ IT-M3424
- ◆ IT-M3434
- ◆ IT-M3415
- ◆ IT-M3425
- ◆ IT-M3435

11.1 IT-M3412

IT-M3412		
Source Parameter V2.2		
Rated value (0 °C~40 °C)	Output Voltage	0~60V
	Output Current	-30A~30A
	Output Power	-200W~200W
	Min. operating voltage	0.6V at -30A
CC	Range	-30A~30A
	Setup Resolution	10mA
	Accuracy	≤0.1%+0.1%FS
CV	Range	0~60V
	Setup Resolution	1mV
	Accuracy	0.02%+0.02%FS
Internal Resistance (CV Priority mode)	Range	0~1000mΩ
	Setup Resolution	0.1mΩ
	Accuracy	2%*Rmax
CP	Range	-200W~200W
	Setup Resolution	0.1W

	Accuracy	1%+1%FS
CR mode (CC Priority mode)	Range	0.6-1000 Ω
	Resolution	Min. 0.1 Ω
	Accuracy	Rmin : (Vreal-Vmax*0.1%)/Rset -Imax*0.2% Rmax : (Vreal+Vmax*0.1%)/Rset +Imax*0.2%
Output Read-back		
Read-back current	Range	-30A~30A
	Resolution	1mA
	Accuracy	≤0.1%+0.1%FS
Read-back Voltage	Range	0-60V
	Resolution	1mV
	Accuracy	0.02%+0.02%FS
Read-back Power	Range	-200W~200W
	Resolution	0.1W
	Accuracy	1%+1%FS
Temperature Coefficient		
Temperature Coefficient	Voltage Temperature Coefficient	30ppm/°C
	Current Temperature Coefficient	50ppm/°C
Battery Test		
AH Measurement	AH Range	0AH-300AH
	Accuracy	0.20%
	Resolution	0.001AH
Regulation		
Load Regulation	Voltage	≤0.02%+0.02%FS
	Current	≤0.03%+0.03%FS
Line Regulation	Voltage	≤0.01%+0.01%FS
	Current	≤0.02%+0.02%FS
Ripple		
Ripple	Voltage	≤100mVp-p
	Current	≤30mArms
value voltage rise/fall time		
Rise time	Voltage (No load)	5ms
Rise time	Voltage (Full load)	10ms
Fall time	Voltage (No load)	5ms
Fall time	Voltage (Full load)	5ms

Transient Response Time	Voltage	$\leq 2\text{mS}$
Output Protection range		
	OCP	-31A or 31A
	OVP	61V
	OPP	-210W or 210W
External analog (optional)		
	Voltage programming	External 0V~10V is 0~60V
	Voltage monitoring	External 0V~10V is 0~60V
	Current programming	External -10V~10V is -30A~30A
	Current monitoring	External -10V~10V is -30A~30A
AC parameters		
Voltage range	100VAC -240VAC	
OVP	264VAC	
UVP	90VAC	
Frequency	47Hz~63Hz	
Max. current (rms)	1Aac (AC220V)	
DC Offset	-0.1A~+0.1A	
Environment		
Working temperature	0- 40 ° C	
Storage temperature	-20- 70°C	
Noise	60dB	
External temperature measurement (IT-E1203)		
Measurement range	-20°C——120°C	
Measurement accuracy	$\pm 1^\circ\text{C}$	
Measurement resolution	0.1°C	
Efficiency		
Max. efficiency (Full-load)	86%	
Communication (Optional)		
Communication interfaces	RS232/USB/RS485/CAN/LAN/GPIB/Analog	
Mechanical parameters		
Size and weight	450mm*214mm*43.5mm	
Net weight	5kg	

11.2 IT-M3422

Parameter	IT-M3422 V2. 2	
Rated value (0 °C~40 °C)	Output Voltage	0~60V
	Output Current	-30A~30A
	Output Power	-400W~400W
	Min. operating voltage	0. 6V at -30A
CC	Range	-30A~30A
	Setup Resolution	10mA
	Accuracy	≤0. 1%+0. 1%FS
CV	Range	0~60V
	Setup Resolution	1mV
	Accuracy	0. 02%+0. 02%FS
Internal Resistance (CV Priority mode)	Range	0~1000m Ω
	Setup Resolution	0. 1m Ω
	Accuracy	2%*Rmax
CP	Range	-400W~400W
	Setup Resolution	0. 1W
	Accuracy	0. 5%+0. 5%FS
CR mode (CC Priority mode)	Range	0. 6~1000 Ω
	Resolution	Min. 0. 1 Ω
	Accuracy	Rmin : (Vreal-Vmax*0.1%)/Rset -Imax*0.2% Rmax : (Vreal+Vmax*0.1%)/Rset +Imax*0.2%
Output Read-back		
Read-back current	Range	-30A~30A
	Resolution	1mA
	Accuracy	≤0. 1%+0. 1%FS
Read-back Voltage	Range	0~60V
	Resolution	1mV
	Accuracy	0. 02%+0. 02%FS
Read-back Power	Range	-400W~400W
	Resolution	0. 1W
	Accuracy	0. 5%+0. 5%FS
Temperature Coefficient		
Temperature Coefficient	Voltage Temperature Coefficient	30ppm/°C

	Current Temperature Coefficient	50ppm/°C
Battery Test		
AH Measurement	AH Range	0AH-300AH
	Accuracy	0.20%
	Resolution	0.001AH
Regulation		
Load Regulation	Voltage	≤0.02%+0.02%FS
	Current	≤0.03%+0.03%FS
Line Regulation	Voltage	≤0.01%+0.01%FS
	Current	≤0.02%+0.02%FS
Ripple		
Ripple	Voltage	≤100mVp-p
	Current	≤30mArms
value voltage rise/fall time		
Rise time	Voltage (No load)	5ms
Rise time	Voltage (Full load)	10ms
Fall time	Voltage (No load)	5ms
Fall time	Voltage (Full load)	5ms
Transient Response Time	Voltage	≤2mS
Output Protection range		
	OCP	-31A or 31A
	OVP	61V
	OPP	-410W or 410W
External analog (optional)		
	Voltage programming	External 0V~10V is 0~60V
	Voltage monitoring	External 0V~10V is 0~60V
	Current programming	External -10V~10V is -30A~30A
	Current monitoring	External -10V~10V is -30A~30A
AC parameters		
Voltage range		100VAC -240VAC
OVP		264VAC
UVP		90VAC
Frequency		47Hz~63Hz
Max. current (rms)		2Aac (AC220V)

DC Offset	-0.1A~+0.1A
Environment	
Working temperature	0- 40 ° C
Storage temperature	-20- 70°C
Noise	60dB
External temperature measurement (IT-E1203)	
Measurement range	-20°C---120°C
Measurement accuracy	±1°C
Measurement resolution	0.1°C
Efficiency	
Max. efficiency (Full-load)	86%
Communication (Optional)	
Communication interfaces	RS232/USB/RS485/CAN/LAN/GPIB/Analog
Mechanical parameters	
Size and weight	450mm*214mm*43.5mm
Net weight	5kg

11.3 IT-M3432

Parameter	IT-M3432 V2. 2	
Rated value (0 °C-40 °C)	Output Voltage	0-60V
	Output Current	-30A~30A
	Output Power	-800W~800W
	Min. operating voltage	0.6V at -30A
CC	Range	-30A~30A
	Setup Resolution	10mA
	Accuracy	≤0.1%+0.1%FS
CV	Range	0-60V
	Setup Resolution	1mV
	Accuracy	0.02%+0.02%FS
Internal Resistance (CV Priority mode)	Range	0-1000mΩ
	Setup Resolution	0.1mΩ
	Accuracy	2%*Rmax

CP	Range	-800W~800W
	Setup Resolution	0.1W
	Accuracy	0.3%+0.3%FS
CR mode (CC Priority mode)	Range	0-1000 Ω
	Resolution	0.1 Ω
	Accuracy	Rmin : (Vreal-Vmax*0.1%)/Rset -Imax*0.2% Rmax : (Vreal +Vmax*0.1%)/Rset +Imax*0.2%
Output Read-back		
Read-back current	Range	-30A~30A
	Resolution	1mA
	Accuracy	≤0.1%+0.1%FS
Read-back Voltage	Range	0-60V
	Resolution	1mV
	Accuracy	0.02%+0.02%FS
Read-back Power	Range	-800W~800W
	Resolution	0.1W
	Accuracy	0.3%+0.3%FS
Temperature Coefficient		
Temperature Coefficient	Voltage Temperature Coefficient	30ppm/°C
	Current Temperature Coefficient	50ppm/°C
Battery Test		
AH Measurement	AH Range	0AH-300AH
	Accuracy	0.20%
	Resolution	0.001AH
Regulation		
Load Regulation	Voltage	≤0.02%+0.02%FS
	Current	≤0.03%+0.03%FS
Line Regulation	Voltage	≤0.01%+0.01%FS
	Current	≤0.02%+0.02%FS
Ripple		
Ripple	Voltage	≤100mVp-p
	Current	≤30mArms
value voltage rise/fall time		
Rise time	Voltage (No load)	5ms
Rise time	Voltage (Full load)	10ms

Fall time	Voltage (No load)	5ms
Fall time	Voltage (Full load)	5ms
Transient Response Time	Voltage	$\leq 2\text{mS}$
Output Protection range		
	OCP	-31A or 31A
	OVP	61V
	OPP	-810W or 810W
External analog (optional)		
	Voltage programming	External 0V~10V is 0~60V
	Voltage monitoring	External 0V~10V is 0~60V
	Current programming	External -10V~10V is -30A~30A
	Current monitoring	External -10V~10V is -30A~30A
AC parameters		
Voltage range		100VAC -240VAC
OVP		264VAC
UVP		90VAC
Frequency		47Hz~63Hz
Max. current (rms)		4Aac (AC220V)
Power factor PF		>0.98 (Lead or Lag)
DC Offset		-0.1A~+0.1A
Harmonic THDI		<5%
Environment		
Working temperature		0- 40 ° C
Storage temperature		-20- 70°C
Noise		60dB
External temperature measurement (IT-E1203)		
Measurement range		-20°C---120°C
Measurement accuracy		$\pm 1^{\circ}\text{C}$
Measurement resolution		0.1°C
Efficiency		
Max. efficiency (Full-load)		86%
Communication (Optional)		
Communication interfaces		RS232/USB/RS485/CAN/LAN/GPIB/Analog
Mechanical parameters		

Size and weight	450mm*214mm*43.5mm
Net weight	5kg

11.4 IT-M3413

Parameter	IT3413 V2.2	
Rated value (0 °C~40 °C)	Output Voltage	0~150V
	Output Current	-12A~12A
	Output Power	-200W~200W
	Min. operating voltage	1.5V at -12A
CC	Range	-12A~12A
	Setup Resolution	1mA
	Accuracy	$\leq 0.1\% + 0.1\%FS$
CV	Range	0~150V
	Setup Resolution	10mV
	Accuracy	$0.02\% + 0.02\%FS$
Internal Resistance (CV Priority mode)	Range	0~1000m Ω
	Setup Resolution	0.1m Ω
	Accuracy	$2\% * R_{max}$
CP	Range	-200W~200W
	Setup Resolution	0.1W
	Accuracy	$1\% + 1\%FS$
CR mode (CC Priority mode)	Range	1.5~1000 Ω
	Resolution	Min. 0.1 Ω
	Accuracy	$R_{min} : (V_{real} - V_{max} * 0.1\%) / R_{set} - I_{max} * 0.2\%$ $R_{max} : (V_{real} + V_{max} * 0.1\%) / R_{set} + I_{max} * 0.2\%$
Output Read-back		
Read-back current	Range	-12A~12A
	Resolution	1mA
	Accuracy	$\leq 0.1\% + 0.1\%FS$
Read-back Voltage	Range	0~150V
	Resolution	10mV
	Accuracy	$0.02\% + 0.02\%FS$
Read-back Power	Range	-200W~200W

	Resolution	0.1W
	Accuracy	1%+1%FS
Temperature Coefficient		
Temperature Coefficient	Voltage Temperature Coefficient	30ppm/°C
	Current Temperature Coefficient	50ppm/°C
Regulation		
Load Regulation	Voltage	≤0.02%+0.02%FS
	Current	≤0.03%+0.03%FS
Line Regulation	Voltage	≤0.01%+0.01%FS
	Current	≤0.02%+0.02%FS
Ripple		
Ripple	Voltage	≤300mVp-p
	Current	≤30mArms
value voltage rise/fall time		
Rise time	Voltage (No load)	20ms
Rise time	Voltage (Full load)	50ms
Fall time	Voltage (No load)	20ms
Fall time	Voltage (Full load)	20ms
Transient Response Time	Voltage	≤2mS
Output Protection range		
	OCP	-12.5A or 12.5A
	OVP	155V
	OPP	-210W or 210W
External analog (optional)		
	Voltage programming	External 0V~10V is 0~150V
	Voltage monitoring	External 0V~10V is 0~150V
	Current programming	External -10V~10V is -12A~12A
	Current monitoring	External -10V~10V is -12A~12A
AC parameters		
Voltage range		100VAC -240VAC
OVP		264VAC
UVP		90VAC
Frequency		47Hz~63Hz

Max. current (rms)	1Aac (AC220)
DC Offset	-0.1A~+0.1A
Environment	
Working temperature	0- 40 ° C
Storage temperature	-20- 70°C
Noise	60dB
External temperature measurement (IT-E1203)	
Measurement range	-20°C——120°C
Measurement accuracy	±1°C
Measurement resolution	0.1°C
Efficiency	
Max. efficiency (Full-load)	88%
Communication (Optional)	
Communication interfaces	RS232/USB/RS485/CAN/LAN/GPIB/Analog
Mechanical parameters	
Size and weight	450mm*214mm*43.5mm
Net weight	5kg

11.5 IT-M3423

Parameter	IT-M3423 V2. 2	
Source Parameter		
Rated value (0 °C-40 °C)	Output Voltage	0-150V
	Output Current	-12A~12A
	Output Power	-400W~400W
	Min. operating voltage	1.5V at -12A
CC	Range	-12A~12A
	Setup Resolution	1mA
	Accuracy	≤0.1%+0.1%FS
CV	Range	0-150V
	Setup Resolution	10mV
	Accuracy	0.02%+0.02%FS

Internal Resistance (CV Priority mode)	Range	0-1000mΩ
	Setup Resolution	0. 1mΩ
	Accuracy	2%*Rmax
CP	Range	-400W~400W
	Setup Resolution	0. 1W
	Accuracy	0. 5%+0. 5%FS
CR mode (CC Priority mode)	Range	1. 5-1000 Ω
	Resolution	Min. 0. 1 Ω
	Accuracy	Rmin : (Vreal-Vmax*0.1%)/Rset -Imax*0.2% Rmax : (Vreal+Vmax*0.1%)/Rset +Imax*0.2%
Output Read-back		
Read-back current	Range	-12A~12A
	Resolution	1mA
	Accuracy	≤0. 1%+0. 1%FS
Read-back Voltage	Range	0-150V
	Resolution	10mV
	Accuracy	0. 02%+0. 02%FS
Read-back Power	Range	-400W~400W
	Resolution	0. 1W
	Accuracy	0.5%+0.5%FS
Temperature Coefficient		
Temperature Coefficient	Voltage Temperature Coefficient	30ppm/°C
	Current Temperature Coefficient	50ppm/°C
Regulation		
Load Regulation	Voltage	≤0.02%+0.02%FS
	Current	≤0.03%+0.03%FS
Line Regulation	Voltage	≤0.01%+0.01%FS
	Current	≤0.02%+0.02%FS
Ripple		
Ripple	Voltage	≤300mVp-p
	Current	≤30mArms
value voltage rise/fall time		
Rise time	Voltage (No load)	20ms
Rise time	Voltage (Full load)	50ms
Fall time	Voltage (No load)	20ms

Fall time	Voltage(Full load)	20ms
Transient Response Time	Voltage	$\leq 2\text{ms}$
Output Protection range		
	OCP	-12. 5A or 12. 5A
	OVP	155V
	OPP	-410W or 410W
External analog (optional)		
	Voltage programming	External 0V~10V is 0~150V
	Voltage monitoring	External 0V~10V is 0~150V
	Current programming	External -10V~10V is -12A~12A
	Current monitoring	External -10V~10V is -12A~12A
AC parameters		
	Voltage range	100VAC -240VAC
	OVP	264VAC
	UVP	90VAC
	Frequency	47Hz~63Hz
	Max. current (rms)	2Aac (AC220)
	DC Offset	-0. 1A~+0. 1A
Environment		
	Working temperature	0- 40 ° C
	Storage temperature	-20- 70°C
	Noise	60dB
External temperature measurement (IT-E1203)		
	Measurement range	-20°C——120°C
	Measurement accuracy	$\pm 1^\circ\text{C}$
	Measurement resolution	0. 1°C
Efficiency		
	Max. efficiency (Full-load)	88%
Communication (Optional)		
	Communication interfaces	RS232/USB/RS485/CAN/LAN/GPIB/Analog
Mechanical parameters		
	Size and weight	450mm*214mm*43. 5mm
	Net weight	5kg

11.6 IT-M3433

Parameter	IT-M3433 V2. 2	
Source Parameter		
Rated value (0 °C~40 °C)	Output Voltage	0~150V
	Output Current	-12A~12A
	Output Power	-800W~800W
	Min. operating voltage	1. 5V at -12A
CC	Range	-12A~12A
	Setup Resolution	1mA
	Accuracy	≤0. 1%+0. 1%FS
CV	Range	0~150V
	Setup Resolution	10mV
	Accuracy	0. 02%+0. 02%FS
Internal Resistance (CV Priority mode)	Range	0~1000m Ω
	Setup Resolution	0. 1m Ω
	Accuracy	2%*Rmax
CP	Range	-800W~800W
	Setup Resolution	0. 1W
	Accuracy	0. 3%+0. 3%FS
CR mode (CC Priority mode)	Range	1. 5~1000 Ω
	Resolution	Min. 0. 1 Ω
	Accuracy	Rmin : (Vreal-Vmax*0.1%)/Rset -Imax*0.2% Rmax : (Vreal+Vmax*0.1%)/Rset +Imax*0.2%
Output Read-back		
Read-back current	Range	-12A~12A
	Resolution	1mA
	Accuracy	≤0. 1%+0. 1%FS
Read-back Voltage	Range	0~150V
	Resolution	10mV
	Accuracy	0. 02%+0. 02%FS
Read-back Power	Range	-800W~800W
	Resolution	0. 1W
	Accuracy	0. 3%+0. 3%FS

Temperature Coefficient		
Temperature Coefficient	Voltage Temperature Coefficient	30ppm/°C
	Current Temperature Coefficient	50ppm/°C
Regulation		
Load Regulation	Voltage	≤0.02%+0.02%FS
	Current	≤0.03%+0.03%FS
Line Regulation	Voltage	≤0.01%+0.01%FS
	Current	≤0.02%+0.02%FS
Ripple		
Ripple	Voltage	≤300mVp-p
	Current	≤30mArms
value voltage rise/fall time		
Rise time	Voltage (No load)	20ms
Rise time	Voltage (Full load)	50ms
Fall time	Voltage (No load)	20ms
Fall time	Voltage (Full load)	20ms
Transient Response Time	Voltage	≤2mS
Output Protection range		
	OCP	-12.5A or 12.5A
	OVP	155V
	OPP	-810W or 810W
External analog (optional)		
	Voltage programming	External 0V~10V is 0~150V
	Voltage monitoring	External 0V~10V is 0~150V
	Current programming	External -10V~10V is -12A~12A
	Current monitoring	External -10V~10V is -12A~12A
AC parameters		
Voltage range		100VAC -240VAC
OVP		264VAC
UVP		90VAC
Frequency		47Hz~63Hz
Max. current (rms)		4Aac (AC220)
Power factor PF		>0.98 (Lead or Lag)

DC Offset	-0.1A~+0.1A
Harmonic THDI	<5%
Environment	
Working temperature	0-40 °C
Storage temperature	-20-70°C
Noise	60dB
External temperature measurement (IT-E1203)	
Measurement range	-20°C—120°C
Measurement accuracy	±1°C
Measurement resolution	0.1°C
Efficiency	
Max. efficiency (Full-load)	88%
Communication (Optional)	
Communication interfaces	RS232/USB/RS485/CAN/LAN/GPIB/Analog
Mechanical parameters	
Size and weight	450mm*214mm*43.5mm
Net weight	5kg

11.7 IT-M3414

Parameter	IT-M3414 V2.2	
Source Parameter		
Rated value (0°C-40°C)	Output Voltage	0~300V
	Output Current	-6A~6A
	Output Power	-200W~200W
	Min. operating voltage	3V at -6A
CC	Range	-6A~6A
	Setup Resolution	1mA
	Accuracy	<0.1% +0.1%FS
CV	Range	0~300V
	Setup Resolution	10mV
	Accuracy	0.02%+0.02%FS
Internal Resistance	Range	0~1000mΩ

(CV Priority mode)	Setup Resolution	0.1mΩ
	Accuracy	2%*Rmax
CP	Range	-200W~200W
	Setup Resolution	0.1W
	Accuracy	1%+1%FS
CR mode (CC Priority mode)	Range	5~1000Ω
	Resolution	min 0.1Ω
	Accuracy	Rmin : (Vreal-Vmax*0.1%)/Rset -Imax*0.2% Rmax : (Vreal+Vmax*0.1%)/Rset +Imax*0.2%
Output Read-back		
Read-back current	Range	-6A~6A
	Resolution	0.1mA
	Accuracy	<0.1% +0.1%FS
Read-back Voltage	Range	0~300V
	Resolution	10mV
	Accuracy	0.02%+0.02%FS
Read-back Power	Range	-200W~200W
	Resolution	0.1W
	Accuracy	1%+1%FS
Temperature Coefficient		
Temperature Coefficient	Voltage Temperature Coefficient	30ppm/°C
	Current Temperature Coefficient	50ppm/°C
Regulation		
Load Regulation	Voltage	≤0.01%+0.01%FS
	Current	≤0.03%+0.03%FS
Line Regulation	Voltage	≤0.01%+0.01%FS
	Current	≤0.02%+0.02%FS
Ripple		
Ripple	Voltage	≤600mVp-p
	Current	≤30mArms
value voltage rise/fall time		
Rise time	Voltage (No load)	20ms
Rise time	Voltage (Full load)	50ms
Fall time	Voltage (No load)	20ms

Fall time	Voltage(Full load)	20ms
Transient Response Time	Voltage	$\leq 2\text{ms}$
Output Protection range		
	OCP	-6.2A or 6.2A
	OVP	305V
	OPP	-210W or 210W
External analog (optional)		
	Voltage programming	External 0V~10V is 0~300V
	Voltage monitoring	External 0V~10V is 0~300V
	Current programming	External -10V~10V is -6A~6A
	Current monitoring	External -10V~10V is -10V~10V
AC parameters		
	Voltage range	100VAC -240VAC
	OVP	264VAC
	UVP	90VAC
	Frequency	47Hz~63Hz
	Max. current (rms)	1Aac (AC220V)
	DC Offset	-0.1A~+0.1A
Environment		
	Working temperature	0- 40°C
	Storage temperature	-20- 70°C
	Noise	60dB
External temperature measurement (IT-E1203)		
	Measurement range	-20°C——120°C
	Measurement accuracy	$\pm 1^\circ\text{C}$
	Measurement resolution	0.1°C
Efficiency		
	Max. efficiency (Full-load)	88%
Communication (Optional)		
	Communication interfaces	RS232/USB/RS485/CAN/LAN/GPIB/Analog
Mechanical parameters		
	Size and weight	450mm*214mm*43.5mm
	Net weight	5kg

11.8 IT-M3424

Parameter		IT3424 V2.2
Source Parameter		
Rated value (0 °C~40 °C)	Output Voltage	0~300V
	Output Current	-6A~6A
	Output Power	-400W~400W
	Min. operating voltage	3V at -6A
CC	Range	-6A~6A
	Setup Resolution	1mA
	Accuracy	≤0.1%+0.1%FS
CV	Range	0~300V
	Setup Resolution	10mV
	Accuracy	0.02%+0.02%FS
Output Resistance	Range	0~1000mΩ
Internal Resistance (CV Priority mode)	Setup Resolution	0.1mΩ
	Accuracy	2%*Rmax
CP	Range	-400W~400W
	Setup Resolution	0.1W
	Accuracy	0.5%+0.5%FS
CR mode (CC Priority mode)	Range	5~1000Ω
	Resolution	Min. 0.1Ω
	Accuracy	Rmin : (Vreal-Vmax*0.1%)/Rset -Imax*0.2% Rmax : (Vreal+Vmax*0.1%)/Rset +Imax*0.2%
Output Read-back		
Read-back current	Range	-6A~6A
	Resolution	0.1mA
	Accuracy	≤0.1%+0.1%FS
Read-back Voltage	Range	0~300V
	Resolution	10mV
	Accuracy	0.02%+0.02%FS
Read-back Power	Range	-400W~400W
	Resolution	0.1W
	Accuracy	0.5%+0.5%FS

Temperature Coefficient		
Temperature Coefficient	Voltage Temperature Coefficient	30ppm/°C
	Current Temperature Coefficient	50ppm/°C
Regulation		
Load Regulation	Voltage	≤0.01%+0.01%FS
	Current	≤0.03%+0.03%FS
Line Regulation	Voltage	≤0.01%+0.01%FS
	Current	≤0.02%+0.02%FS
Ripple		
Ripple	Voltage	≤600mVp-p
	Current	≤30mArms
value voltage rise/fall time		
Rise time	Voltage (No load)	20ms
Rise time	Voltage (Full load)	50ms
Fall time	Voltage (No load)	20ms
Fall time	Voltage (Full load)	20ms
Transient Response Time	Voltage	≤2mS
Output Protection range		
	OCP	-6. 2A or 6. 2A
	OVP	305V
	OPP	-410W or 410W
External analog (optional)		
	Voltage programming	External 0V~10V is 0~300V
	Voltage monitoring	External 0V~10V is 0~300V
	Current programming	External -10V~10V is -6A~6A
	Current monitoring	External -10V~10V is -6A~6A
AC parameters		
Voltage range		100VAC -240VAC
OVP		264VAC
UVP		90VAC
Frequency		47Hz~63Hz
Max. current (rms)		2Aac (AC220V)
DC Offset		-0. 1A~+0. 1A

Environment	
Working temperature	0- 40 ° C
Storage temperature	-20- 70°C
Noise	60dB
External temperature measurement (IT-E1203)	
Measurement range	-20°C——120°C
Measurement accuracy	±1°C
Measurement resolution	0.1°C
Efficiency	
Max. efficiency (Full-load)	88%
Communication (Optional)	
Communication interfaces	RS232/USB/RS485/CAN/LAN/GPIB/Analog
Mechanical parameters	
Size and weight	450mm*214mm*43.5mm
Net weight	5kg

11.9 IT-M3434

Parameter	IT-M3434 V2. 2	
Source Parameter		
Rated value (0 °C-40 °C)	Output Voltage	0-300V
	Output Current	-6A~6A
	Output Power	-800W~800W
	Min. operating voltage	3V at -6A
CC	Range	-6A~6A
	Setup Resolution	1mA
	Accuracy	≤0.1%+0.1%FS
CV	Range	0-300V
	Setup Resolution	10mV
	Accuracy	0.02%+0.02%FS
Internal Resistance (CV Priority mode)	Range	0-1000mΩ
	Setup Resolution	0.1mΩ
	Accuracy	2%*Rmax

CP	Range	-800W~800W
	Setup Resolution	0.1W
	Accuracy	0.3%+0.3%FS
CR mode (CC Priority mode)	Range	5-1000 Ω
	Resolution	Min. 0.1 Ω
	Accuracy	Rmin : $(V_{real}-V_{max}*0.1\%)/R_{set} -I_{max}*0.2\%$ Rmax : $(V_{real}+V_{max}*0.1\%)/R_{set} +I_{max}*0.2\%$
Output Read-back		
Read-back current	Range	-6A~6A
	Resolution	0.1mA
	Accuracy	$\leq 0.1\%+0.1\%FS$
Read-back Voltage	Range	0-300V
	Resolution	10mV
	Accuracy	0.02%+0.02%FS
Read-back Power	Range	-800W~800W
	Resolution	0.1W
	Accuracy	0.3%+0.3%FS
Temperature Coefficient		
Temperature Coefficient	Voltage Temperature Coefficient	30ppm/°C
	Current Temperature Coefficient	50ppm/°C
Regulation		
Load Regulation	Voltage	$\leq 0.01\%+0.01\%FS$
	Current	$\leq 0.03\%+0.03\%FS$
Line Regulation	Voltage	$\leq 0.01\%+0.01\%FS$
	Current	$\leq 0.02\%+0.02\%FS$
Ripple		
Ripple	Voltage	$\leq 600mV_{p-p}$
	Current	$\leq 30mA_{rms}$
value voltage rise/fall time		
Rise time	Voltage (No load)	20ms
Rise time	Voltage (Full load)	50ms
Fall time	Voltage (No load)	20ms
Fall time	Voltage (Full load)	20ms
Transient Response Time	Voltage	$\leq 2mS$

Output Protection range	
OCP	-6.2A or 6.2A
OVP	305V
OPP	-810W or 810W
External analog (optional)	
Voltage programming	External 0V~10V is 0~300V
Voltage monitoring	External 0V~10V is 0~300V
Current programming	External -10V~10V is -6A~6A
Current monitoring	External -10V~10V is -6A~6A
AC parameters	
Voltage range	100VAC -240VAC
OVP	264VAC
UVP	90VAC
Frequency	47Hz~63Hz
Max. current (rms)	4Aac (AC220V)
Power factor PF	>0.98 (Lead or Lag)
DC Offset	-0.1A~+0.1A
Harmonic THDI	<5%
Environment	
Working temperature	0- 40 ° C
Storage temperature	-20- 70°C
Noise	60dB
External temperature measurement	
Measurement range	-20°C——120°C
Measurement accuracy	±1°C
Measurement resolution	0.1°C
Efficiency	
Max. efficiency (Full-load)	88%
Communication (Optional)	
Communication interfaces	RS232/USB/RS485/CAN/LAN/GPIB/Analog
Mechanical parameters	
Size and weight	450mm*214mm*43.5mm
Net weight	5kg

11.10 IT-M3415

Parameter	IT-M3415 V2. 2	
Source Parameter		
Rated value (0 °C~40 °C)	Output Voltage	0~600V
	Output Current	-3A~3A
	Output Power	-200W~200W
	Min. operating voltage	3V at -3A
CC	Range	-3A~3A
	Setup Resolution	1mA
	Accuracy	≤0.1%+0.1%FS
CV	Range	0~600V
	Setup Resolution	10mV
	Accuracy	0.02%+0.02%FS
Internal Resistance (CV Priority mode)	Range	0~1000mΩ
	Setup Resolution	0.1mΩ
	Accuracy	2%*Rmax
CP	Range	-200W~200W
	Setup Resolution	0.1W
	Accuracy	1%+1%FS
CR mode (CC Priority mode)	Range	20~1000 Ω
	Resolution	Min. 0.1 Ω
	Accuracy	Rmin : (Vreal-Vmax*0.1%)/Rset -Imax*0.2% Rmax : (Vreal+Vmax*0.1%)/Rset +Imax*0.2%
Output Read-back		
Read-back current	Range	-3A~3A
	Resolution	0.1mA
	Accuracy	≤0.1%+0.1%FS
Read-back Voltage	Range	0~600V
	Resolution	10mV
	Accuracy	0.02%+0.02%FS
Read-back Power	Range	-200W~200W
	Resolution	0.1W
	Accuracy	1%+1%FS
Temperature Coefficient		
Temperature Coefficient	Voltage Temperature Coefficient	30ppm/°C

	Current Temperature Coefficient	50ppm/°C
Regulation		
Load Regulation	Voltage	≤0.01%+0.01%FS
	Current	≤0.03%+0.03%FS
Line Regulation	Voltage	≤0.01%+0.01%FS
	Current	≤0.02%+0.02%FS
Ripple		
Ripple	Voltage	≤1200mVp-p
	Current	≤30mArms
value voltage rise/fall time		
Rise time	Voltage (No load)	30ms
Rise time	Voltage (Full load)	60ms
Fall time	Voltage (No load)	30ms
Fall time	Voltage (Full load)	30ms
Transient Response Time	Voltage	≤2mS
Output Protection range		
	OCP	-3.1A or 3.1A
	OVP	610V
	OPP	-210W or 210W
External analog (optional)		
	Voltage programming	External 0V~10V is 0~600V
	Voltage monitoring	External 0V~10V is 0~600V
	Current programming	External -10V~10V is -3A~3A
	Current monitoring	External -10V~10V is -3A~3A
AC parameters		
Voltage range		100VAC -240VAC
OVP		264VAC
UVP		90VAC
Frequency		47Hz~63Hz
Max. current (rms)		1Aac (AC220V)
DC Offset		-0.1A~+0.1A
Environment		
Working temperature		0- 40°C
Storage temperature		-20- 70°C

Noise	60dB
External temperature measurement	
Measurement range	-20℃——120℃
Measurement accuracy	±1℃
Measurement resolution	0.1℃
Efficiency	
Max. efficiency (Full-load)	88%
Communication (Optional)	
Communication interfaces	RS232/USB/RS485/CAN/LAN/GPIB/Analog
Mechanical parameters	
Size and weight	450mm*214mm*43.5mm
Net weight	5kg

11.11 IT-M3425

Parameter	IT-M3425 V2. 2	
Source Parameter		
Rated value (0℃-40℃)	Output Voltage	0-600V
	Output Current	-3A~3A
	Output Power	-400W~400W
	Min. operating voltage	3V at -3A
CC	Range	-3A~3A
	Setup Resolution	1mA
	Accuracy	≤0.1%+0.1%FS
CV	Range	0-600V
	Setup Resolution	10mV
	Accuracy	0.02%+0.02%FS
Internal Resistance (CV Priority mode)	Range	0-1000mΩ
	Setup Resolution	0.1mΩ
	Accuracy	2%*Rmax
CP	Range	-400W~400W
	Setup Resolution	0.1W
	Accuracy	0.5%+0.5%FS

CR mode (CC Priority mode)	Range	20-1000 Ω
	Resolution	Min. 0.1 Ω
	Accuracy	Rmin : $(V_{real}-V_{max}*0.1\%)/R_{set} -I_{max}*0.2\%$ Rmax : $(V_{real}+V_{max}*0.1\%)/R_{set} +I_{max}*0.2\%$
Output Read-back		
Read-back current	Range	-3A~3A
	Resolution	0.1mA
	Accuracy	$\leq 0.1\%+0.1\%FS$
Read-back Voltage	Range	0-600V
	Resolution	10mV
	Accuracy	0.02%+0.02%FS
Read-back Power	Range	-400W~400W
	Resolution	0.1W
	Accuracy	0.5%+0.5%FS
Temperature Coefficient		
Temperature Coefficient	Voltage Temperature Coefficient	30ppm/ $^{\circ}C$
	Current Temperature Coefficient	50ppm/ $^{\circ}C$
Regulation		
Load Regulation	Voltage	$\leq 0.01\%+0.01\%FS$
	Current	$\leq 0.03\%+0.03\%FS$
Line Regulation	Voltage	$\leq 0.01\%+0.01\%FS$
	Current	$\leq 0.02\%+0.02\%FS$
Ripple		
Ripple	Voltage	$\leq 1200mVp-p$
	Current	$\leq 30mArms$
value voltage rise/fall time		
Rise time	Voltage (No load)	30ms
Rise time	Voltage (Full load)	60ms
Fall time	Voltage (No load)	30ms
Fall time	Voltage (Full load)	30ms
Transient Response Time	Voltage	$\leq 2mS$
Output Protection range		
OCP		-3.1A or 3.1A

OVP	610V
OPP	-410W or 410W
External analog (optional)	
Voltage programming	External 0V~10V is 0~600V
Voltage monitoring	External 0V~10V is 0~600V
Current programming	External -10V~10V is -3A~3A
Current monitoring	External -10V~10V is -3A~3A
AC parameters	
Voltage range	100VAC -240VAC
OVP	264VAC
UVP	90VAC
Frequency	47Hz~63Hz
Max. current (rms)	2Aac (AC220V)
DC Offset	-0.1A~+0.1A
Environment	
Working temperature	0- 40 ° C
Storage temperature	-20- 70°C
Noise	60dB
External temperature measurement	
Measurement range	-20°C——120°C
Measurement accuracy	±1°C
Measurement resolution	0.1°C
Efficiency	
Max. efficiency (Full-load)	88%
Communication (Optional)	
Communication interfaces	RS232/USB/RS485/CAN/LAN/GPIB/Analog
Mechanical parameters	
Size and weight	450mm*214mm*43.5mm
Net weight	5kg

11.12 IT-M3435

Parameter	IT-M3435 V2. 2	
Source Parameter		
Rated value (0 °C~40 °C)	Output Voltage	0~600V
	Output Current	-3A~3A
	Output Power	-800W~800W
	Min. operating voltage	3V at -3A
CC	Range	-3A~3A
	Setup Resolution	1mA
	Accuracy	≤0.1%+0.1%FS
CV	Range	0~600V
	Setup Resolution	10mV
	Accuracy	0.02%+0.02%FS
Internal Resistance (CV Priority mode)	Range	0~1000mΩ
	Setup Resolution	0.1mΩ
	Accuracy	2%*Rmax
CP	Range	-800W~800W
	Setup Resolution	0.1W
	Accuracy	0.3%+0.3%FS
CR mode (CC Priority mode)	Range	20~1000 Ω
	Resolution	Min. 0.1 Ω
	Accuracy	Rmin : (Vreal-Vmax*0.1%)/Rset -Imax*0.2% Rmax : (Vreal+Vmax*0.1%)/Rset +Imax*0.2%
Output Read-back		
Read-back current	Range	-3A~3A
	Resolution	0.1mA
	Accuracy	≤0.1%+0.1%FS
Read-back Voltage	Range	0~600V
	Resolution	10mV
	Accuracy	0.02%+0.02%FS
Read-back Power	Range	-800W~800W
	Resolution	0.1W
	Accuracy	0.3%+0.3%FS
Temperature Coefficient		
Temperature Coefficient	Voltage Temperature Coefficient	30ppm/°C

	Current Temperature Coefficient	50ppm/°C
Regulation		
Load Regulation	Voltage	≤0.01%+0.01%FS
	Current	≤0.03%+0.03%FS
Line Regulation	Voltage	≤0.01%+0.01%FS
	Current	≤0.02%+0.02%FS
Ripple		
Ripple	Voltage	≤1200mVp-p
	Current	≤30mArms
value voltage rise/fall time		
Rise time	Voltage (No load)	30ms
Rise time	Voltage (Full load)	60ms
Fall time	Voltage (No load)	30ms
Fall time	Voltage (Full load)	30ms
Transient Response Time	Voltage	≤2mS
Output Protection range		
	OCP	-3.1A or 3.1A
	OVP	610V
	OPP	-810W or 810W
External analog (optional)		
	Voltage programming	External 0V~10V is 0~600V
	Voltage monitoring	External 0V~10V is 0~600V
	Current programming	External -10V~10V is -3A~3A
	Current monitoring	External -10V~10V is -3A~3A
AC parameters		
Voltage range		100VAC -240VAC
OVP		264VAC
UVP		90VAC
Frequency		47Hz~63Hz
Max. current (rms)		4Aac (AC220V)
Power factor PF		>0.98 (Lead or Lag)
DC Offset		-0.1A~+0.1A
Harmonic THDI		<5%
Environment		

Working temperature	0- 40 ° C
Storage temperature	-20- 70°C
Noise	60dB
External temperature measurement (IT-E1203)	
Measurement range	-20°C——120°C
Measurement accuracy	±1°C
Measurement resolution	0.1°C
Efficiency	
Max. efficiency (Full-load)	88%
Communication (Optional)	
Communication interfaces	RS232/USB/RS485/CAN/LAN/GPIB/Analog
Mechanical parameters	
Size and weight	450mm*214mm*43.5mm
Net weight	5kg

12 Supplemental Characteristics

Recommended calibration frequency: once a year

Cooling style: fans

A Appendix

◆ Specifications of Red and Black Test Cables

A.1 Specifications of Red and Black Test Cables

ITECH provides you with optional red and black test cables, which are sold individually and you can select for test. For specifications of ITECH test cables and maximum current values, refer to the table below.

Model	Specification
IT-E30110-AB	1kV/10A/1m*2pcs Alligator clips-Banana plugs
IT-E30110-BB	1kV/10A/1m*2pcs Banana plugs-Banana plugs
IT-E30110-BY	1kV/10A/1m*2pcs Banana plugs-Y-type terminals
IT-E30312-YY	500V/30A/1.2m*2pcs Y-type terminals-Y-type terminals
IT-E30320-YY	500V/30A/2m*2pcs Y-type terminals-Y-type terminals
IT-E30615-OO	500V/60A/1.5m*2pcs Ring terminals-Ring terminals
IT-E31005LIC-OO	600V/100A/0.5m*2pcs Ring terminal low inductance
IT-E31010LIC-OO	600V/100A/1m*2pcs Ring terminal low inductance
IT-E31020LIC-OO	600V/100A/2m*2pcs Ring terminal low inductance
IT-E31040LIC-OO	600V/100A/2m*2pcs Ring terminal low inductance
IT-E31220-OO	500V/120A/2m*2pcs Ring terminals-Ring terminals
IT-E31250-OO	500V/120A/5m*2pcs Ring terminals-Ring terminals
IT-E32410-OO	500V/240A/1m*2pcs Ring terminals-Ring terminals
IT-E32420-OO	500V/240A/2m*2pcs Ring terminals-Ring terminals
IT-E32450-OO	500V/240A/5m*2pcs Ring terminals-Ring terminals
IT-E3301020-OO	3kV/100A/2m*2pcs Ring terminals-Ring terminals
IT-E3301050-OO	3kV/100A/5m*2pcs Ring terminals-Ring terminals
IT-E3302420-OO	3kV/240A/2m*2pcs Ring terminals-Ring terminals

IT-E3302450-OO	3kV/240A/5m*2pcs Ring terminals-Ring terminals
IT-E3303620-OO	3kV/360A/2m*2pcs Ring terminals-Ring terminals
IT-E3304020-OO	3kV/400A/2m*2pcs Ring terminals-Ring terminals
IT-E33620-OO	500V/360A/2m*2pcs Ring terminals-Ring terminals
IT-E33650-OO	500V/360A/5m*2pcs Ring terminals-Ring terminals
IT-E34020-OO	500V/400A/2m*2pcs Ring terminals-Ring terminals
IT-E34520-OO	500V/450A/2m*2pcs Ring terminals-Ring terminals
IT-E35030-OO	500V/360A/3m*2pcs Ring terminals-Ring terminals
IT-E36530-OO	500V/650A/3m*2pcs Ring terminals-Ring terminals

For maximum current of AWG copper wire, refer to table below.

AWG	8	10	12	14	16	18	20	22	24	26	28
The Maximum Current Value (A)	60	40	30	20	13	10	7	5	3.5	2.5	1.7



Note

- AWG (American Wire Gage), it means X wire (marked on the wire). The table above lists current capacity of single wire at working temperature of 30°C. For reference only.
- Along with temperature, you must also consider voltage drop when selecting wire sizes.

Although the instrument will compensate for the voltage in the wires, it is recommended to minimize the voltage drop as much as possible to prevent excessive power consumption from the instrument and poor dynamic response to load changes. Larger diameter wire sizes will help minimize wire voltage drops. Twisting or bundling wires will help reduce transient voltage drops.

Connect with us

Thank you for purchasing ITECH products. Any questions, pls. feel free to let us know.

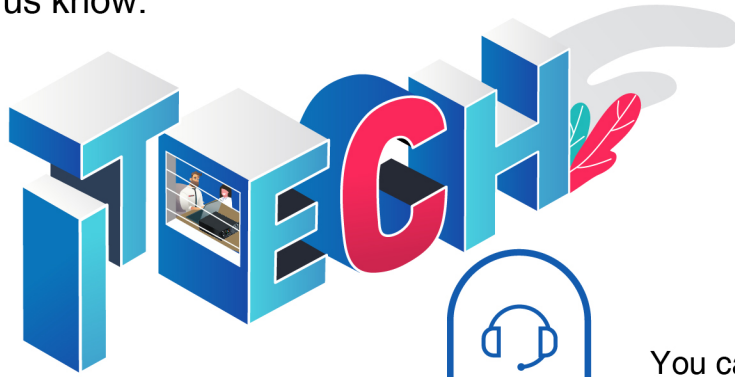

You can chat with us on ITECH website



For more information, pls. visit www.itechate.com



Click and follow ITECH Electronics

