



UK  
CA  
CE

# PQA924

User manual



**TABLE OF CONTENTS**

|           |   |           |
|-----------|---|-----------|
| <b>1.</b> | <b>PRECAUTIONS AND SAFETY MEASURES .....</b>                          | <b>3</b>  |
| 1.1.      | General information .....   | 3         |
| 1.2.      | Preliminary instructions .....  | 4         |
| 1.3.      | During use.....   | 5         |
| 1.4.      | After use.....  | 5         |
| <b>2.</b> | <b>GENERAL DESCRIPTION .....</b>                                      | <b>6</b>  |
| 2.1.      | Foreword.....   | 6         |
| 2.2.      | Instrument functions .....  | 6         |
| 2.3.      | Initial Screen .....  | 6         |
| <b>3.</b> | <b>PREPARATION FOR USE .....</b>                                      | <b>7</b>  |
| 3.1.      | Initial checks.....   | 7         |
| 3.2.      | Instrument power supply .....   | 7         |
| 3.3.      | Storage .....   | 7         |
| <b>4.</b> | <b>DESCRIPTION OF PARTS.....</b>                                      | <b>8</b>  |
| 4.1.      | Instrument description .....  | 8         |
| 4.2.      | Description of function keys.....                                     | 9         |
| 4.3.      | Display description .....   | 10        |
| <b>5.</b> | <b>GENERAL MENU .....</b>   | <b>11</b> |
| 5.1.      | General instrument settings.....                                      | 12        |
| 5.1.1.    | Setting the language of the system .....                              | 12        |
| 5.1.2.    | Definition of measuring cable colors and internal parameters .....    | 13        |
| 5.1.3.    | Adjusting the display brightness .....                                | 14        |
| 5.1.4.    | Setting the key tone.....   | 14        |
| 5.1.5.    | Auto Power Off setting.....   | 14        |
| 5.1.6.    | Setting the security password.....                                    | 14        |
| 5.1.7.    | Setting the WiFi Hotspot.....   | 15        |
| 5.1.8.    | Touch screen display calibration .....                                | 15        |
| 5.1.9.    | Setting the operator's name .....                                     | 16        |
| 5.1.10.   | Date/Time Setting .....   | 16        |
| 5.1.11.   | Setting up communication via the Ethernet network .....               | 17        |
| 5.2.      | Analyser configuration .....  | 20        |
| 5.2.1.    | Setting the type of system, the frequency and the rated voltage ..... | 20        |
| 5.2.2.    | Setting the type of clamp-on transducers.....                         | 21        |
| 5.2.3.    | Setting the parameters for current measurement on external CTs .....  | 23        |
| 5.3.      | Recorder configuration .....  | 26        |
| 5.3.1.    | Setting the recording parameters .....                                | 27        |
| 5.3.2.    | Setting predefined configurations .....                               | 31        |
| 5.4.      | Multimeter Function.....  | 32        |
| 5.1.1.    | Display of numerical values.....                                      | 32        |
| 5.1.2.    | Signal waveform display.....  | 36        |
| 5.1.3.    | Display of harmonic analysis .....                                    | 39        |
| 5.1.4.    | Vectorial diagram display .....                                       | 44        |
| <b>6.</b> | <b>OPERATING INSTRUCTIONS .....</b>                                   | <b>47</b> |
| 6.1.      | Instrument connections to the system .....                            | 47        |
| 6.1.1.    | Single-Phase 2 Wires system.....                                      | 47        |
| 6.1.2.    | Three-Phase 4 Wires system .....                                      | 48        |
| 6.1.3.    | Three-Phases 3 Wires system .....                                     | 49        |
| 6.1.4.    | Three-Phase 3 Wires Aron system .....                                 | 50        |
| 6.1.5.    | Three-Phase 4 Wires system and 3P HL central socket.....              | 51        |
| 6.1.6.    | Three-Phase 3 Wires system 3P 2E .....                                | 52        |
| 6.1.7.    | Split Phase 3 Wires 1P PC system .....                                | 53        |
| 6.2.      | Autoset function.....   | 54        |
| 6.3.      | Starting and stopping a recording.....                                | 57        |
| 6.4.      | Stored data.....  | 59        |
| 6.5.      | Instrument Info .....   | 60        |
| <b>7.</b> | <b>CONNECTING THE INSTRUMENT TO A PC .....</b>                        | <b>61</b> |
| <b>8.</b> | <b>MAINTENANCE.....</b>   | <b>64</b> |

|            |  |           |
|------------|--|-----------|
| 8.1.       | General information .....  | 64        |
| 8.2.       | Replacing or recharging internal batteries .....                         | 64        |
| 8.3.       | Instrument cleaning .....  | 65        |
| <b>9.</b>  | <b>TECHNICAL SPECIFICATIONS.....</b>                                     | <b>66</b> |
| 9.1.       | Technical specifications.....  | 66        |
| 9.2.       | General characteristics.....   | 70        |
| 9.3.       | Environmental conditions for use.....                                    | 71        |
| 9.4.       | Accessories.....   | 71        |
| <b>10.</b> | <b>APPENDIX – THEORETICAL OUTLINES .....</b>                             | <b>72</b> |
| 10.1.      | Voltage anomalies .....  | 72        |
| 10.2.      | Voltage and current harmonics .....                                      | 73        |
| 10.2.1.    | Theory.....  | 73        |
| 10.2.2.    | Limit values for voltage harmonics .....                                 | 74        |
| 10.2.3.    | Causes of the presence of harmonics .....                                | 75        |
| 10.2.4.    | Consequence of the presence of harmonics .....                           | 76        |
| 10.2.5.    | Parameters for the selection of electrical transformers - K factor ..... | 76        |
| 10.2.6.    | Interharmonics .....   | 77        |
| 10.3.      | Inrush currents.....   | 78        |
| 10.4.      | Voltage Flicker .....  | 80        |
| 10.5.      | Voltage dissymmetry .....  | 81        |
| 10.6.      | Fast voltage transients.....   | 82        |
| 10.7.      | Calculated network parameter definitions .....                           | 83        |
| 10.7.1.    | Conventions on powers and power factors .....                            | 85        |
| 10.7.2.    | ARON INSERTION.....  | 87        |
| 10.8.      | Connecting the instrument with external CTs.....                         | 88        |
| 10.9.      | Measurement Method.....  | 89        |
| <b>11.</b> | <b>SERVICE .....</b>   | <b>90</b> |
| 11.1.      | Warranty Conditions .....  | 90        |
| 11.2.      | Service .....  | 90        |

## 1. PRECAUTIONS AND SAFETY MEASURES

### 1.1. GENERAL INFORMATION

This instrument has been designed to comply with the IEC/EN61010-1 Directive on electronic measuring equipment. For your safety and to avoid damage to the instrument, please follow the procedures described in this manual and read carefully all instructions preceded by the symbol .

Comply with the following instructions before and during measurements:

- Do not take voltage or current measurements in humid environments.
- Do not take measurements near explosive gases or materials and fuels, or in dusty environments.
- Avoid contact with the circuit under test when no measurement is being made.
- Avoid contact with exposed metal parts, unused measuring terminals, circuits, etc.
- Do not take any measurements if you notice any abnormalities in the instrument, such as deformation, breakage, leakage of substances, no reading on the display, etc.

The following symbols are used in this manual and on the instrument:



CAUTION: follow the instructions given in this manual; improper use may cause damage to the instrument, its components or dangerous situations for the operator.



High voltage hazard: risk of electric shock



Double insulation



AC Voltage or Current



Earth reference



WARNING: The symbol on the instrument indicates that it and its accessories must be collected separately and disposed of correctly

## 1.2. PRELIMINARY INSTRUCTIONS

- The instrument has been designed to be used in the environmental conditions specified in § 9.3. The presence of significantly different environmental conditions can compromise the safety of the instrument and the operator. In any case, before using the instrument, wait until the conditions inside the instrument are comparable to the environment in which it will be used.
- It can be used for **VOLTAGE** and **CURRENT** measurements on installations with overvoltage category CAT IV 600VAC, CAT III 1000VAC to earth with a maximum voltage of 1000V between the inputs.
- We advise you to follow the normal safety procedures for working on live equipment and to use the PPE provided to protect against dangerous currents and to protect the instrument from misuse
- If the absence of an indication of the presence of voltage could pose a risk to the operator, a continuity measurement must always be carried out before the voltage measurement to confirm the correct connection and status of the terminals
- Only the accessories supplied with the instrument guarantee compliance with the safety standards. They must be in good condition and must be replaced, if necessary, with identical models.
- Do not measure circuits that exceed the specified current and voltage limits.
- Before connecting the cables, crocodile clips and clamps to the circuit under consideration, check that the desired function is selected.



### CAUTION

When using the instrument for the first time after purchase, carry out a full charge of the internal batteries and leave them to charge for a minimum of 14 hours.

### 1.3. DURING USE

Read the following recommendations and instructions carefully:



#### CAUTION

Failure to comply with the Warnings and/or Instructions may result in damage to the instrument and/or its components or personal injury to the operator.

- When the instrument is connected to the circuit under consideration, never touch any unused terminal.
- When measuring currents, any other current in the vicinity of the clamps can affect the accuracy of the measurement.
- When measuring currents, always place the conductor as close to the centre of the toroidal sensor as possible in order to obtain a more accurate reading.
- If the value or sign of the quantity in question remains constant during a measurement, check whether the "**HOLD**" function is activated.

### 1.4. AFTER USE

- When the measurements have been completed, switch off the instrument by pressing the **ON/OFF** key.
- If the instrument is not to be used for a long period of time, follow the storage instructions in § 3.3

## 2. GENERAL DESCRIPTION

### 2.1. FOREWORD

The **PQA924** is designed to provide the quickest and easiest way to perform power quality studies in accordance with the **IEC/EN61000-4-30** standard, offering a touch-screen user interface, advanced auto-configuration features and intuitive software for analysing results and generating printed reports. PQA924 also offers high accuracy (**S-class**). This is often required for advanced power quality studies.

### 2.2. INSTRUMENT FUNCTIONS

PQA924 is able to capture any critical event related to the quality of electrical energy: fast voltage transients, harmonics and **interharmonics** of voltage and current, power harmonics, voltage drops, Flicker analysis, i.e. all the possible parameters that allow to characterise the electrical system in question. In particular, the instrument can record up to **3180 channels**, voltage-current events, all simultaneously:

- **Up to 386 channels** between network parameters (130 categories: frequency, voltages, currents, powers, etc.)
- **Up to 2228** harmonic values (amplitudes and phases of voltage and current harmonics up to the 63rd order, amplitude of power harmonics up to the 63rd order, THD%, k factors)
- **Up to 536** interharmonic values (up to the 63rd interharmonic groups for voltages and currents, THD%)
- **Up to 24 channels** on energy data (active and reactive energies)
- **Up to 6 channels** for Flicker data (Pst, Plt voltages)
- Events associated with voltage drops, voltage variations and voltage interruptions
- Events associated with fast voltage transients (**max Voltage 8kV, minimum duration 1µs**)
- Events associated with inrush current

### 2.3. INITIAL SCREEN

When the instrument is switched on using the **ON/OFF** key, the following screen will appear for a few seconds during initialisation:

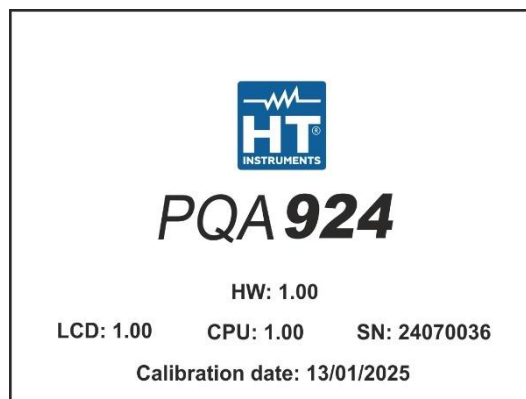

In addition to the manufacturer details and the model of the instrument, it also displays:

- The serial number of the instrument (SN).
- The Firmware and Hardware versions of the instrument (LCD, CPU, HW).
- The date of the last calibration performed (Calibration Date:).

### 3. PREPARATION FOR USE

#### 3.1. INITIAL CHECKS

The instrument has been electrically and mechanically checked. All possible precautions have been taken so that it could be delivered without damage. However, it is advisable to check it briefly to see if it has been damaged during transport. If anomalies are found, contact your freight forwarder immediately. It is also advisable to check the standard equipment on the enclosed packing list. In case of discrepancies, contact your dealer. Should it be necessary to return the instrument, please follow the instructions given in § 11.

#### 3.2. INSTRUMENT POWER SUPPLY

The instrument can be powered by 6x1.5V AA alkaline batteries or 6x1.2V AA NiMH batteries, which can be recharged via the supplied external power pack. For instructions on replacing or recharging the batteries, see § 8.2.



#### CAUTION

- If you intend to make a recording, it is **recommended** that you use the external power pack supplied
- **When using the instrument for the first time after purchase, carry out a full charge of the internal batteries and leave them to charge for a minimum of 14 hours**
- **The instrument retains data even without batteries**
- **The instrument does not recharge NiMH batteries at temperatures outside the range allowed by the same (0 °C ÷ 40 °C)**
- **Use only batteries of the same type (so either only alkaline or only rechargeable NiMH)**
- **The instrument will not charge the batteries if it cannot recognize the type of battery used (i.e. if NiMH and alkaline batteries are mistakenly present)**

To maximize battery life, the instrument has an Auto-off function that activates **approximately 5 minutes** after a button or touch screen contact is pressed (see § 5.1.5).

#### 3.3. STORAGE

The instrument has been designed to be used in the environmental conditions specified in § 9.3. The presence of significantly different environmental conditions can compromise the safety of the instrument and the operator and/or not guarantee precise measurements. **Remove the batteries if the instrument is not to be used for an extended period of time.** After long period of storage and/or in extreme environmental conditions, wait until the conditions inside the instrument are comparable to those in the environment in which it will be used.



## 4. DESCRIPTION OF PARTS

### 4.1. INSTRUMENT DESCRIPTION

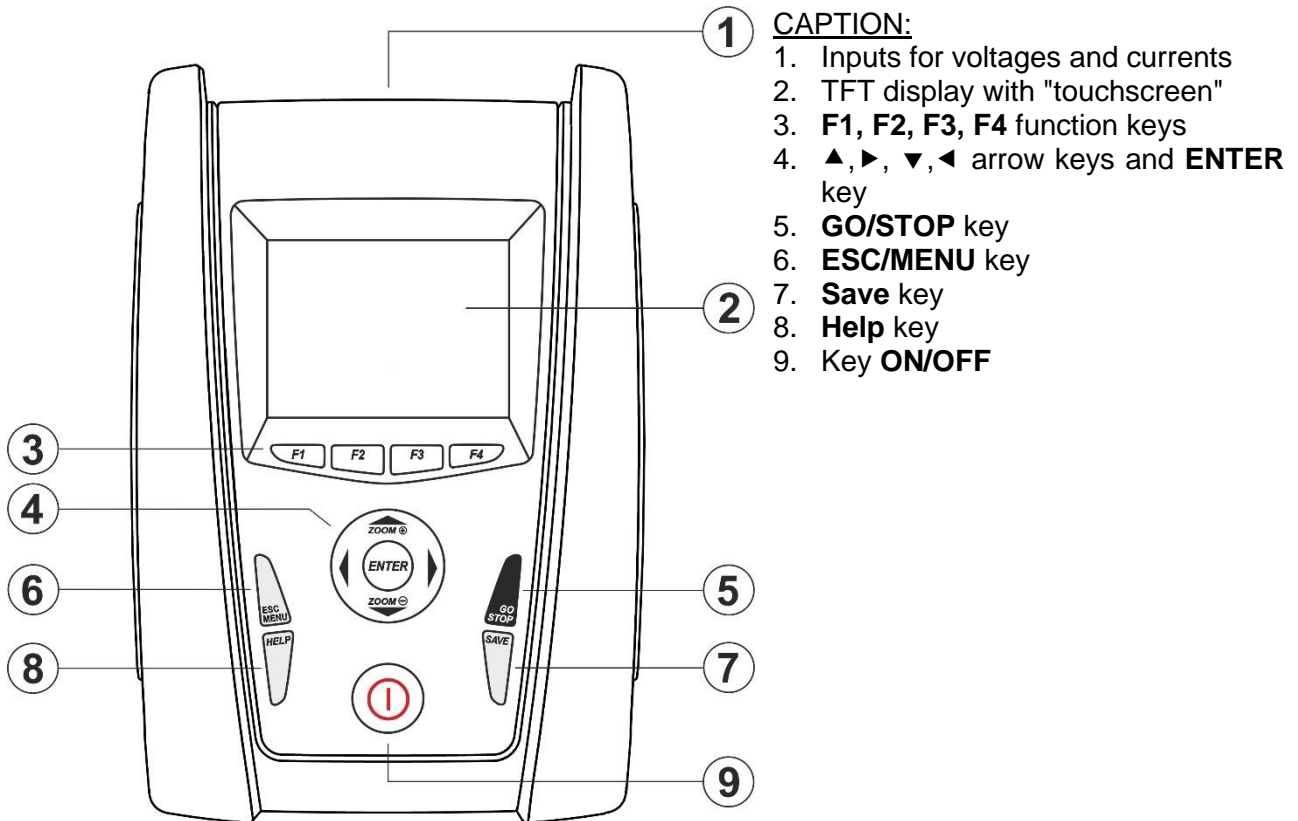

Fig. 1: Description of the front part of the instrument

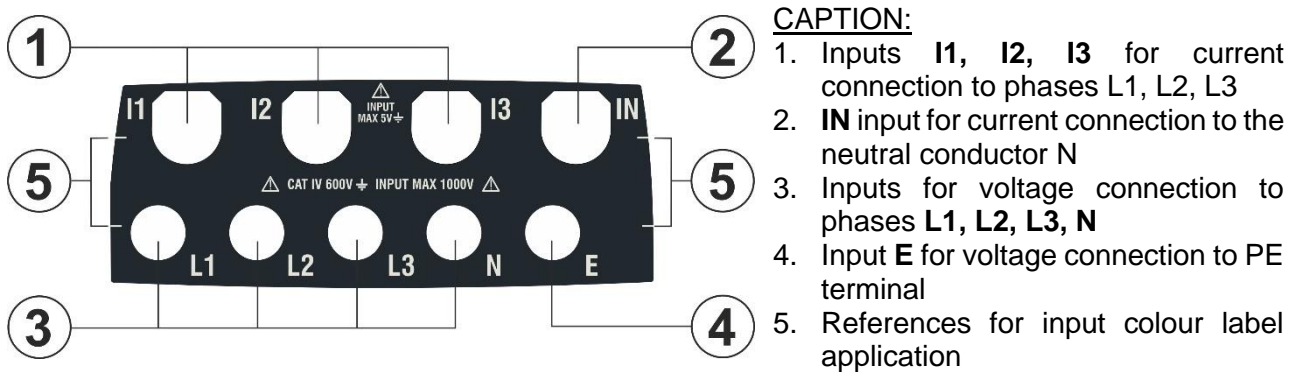

Fig. 2: Description of instrument input terminals

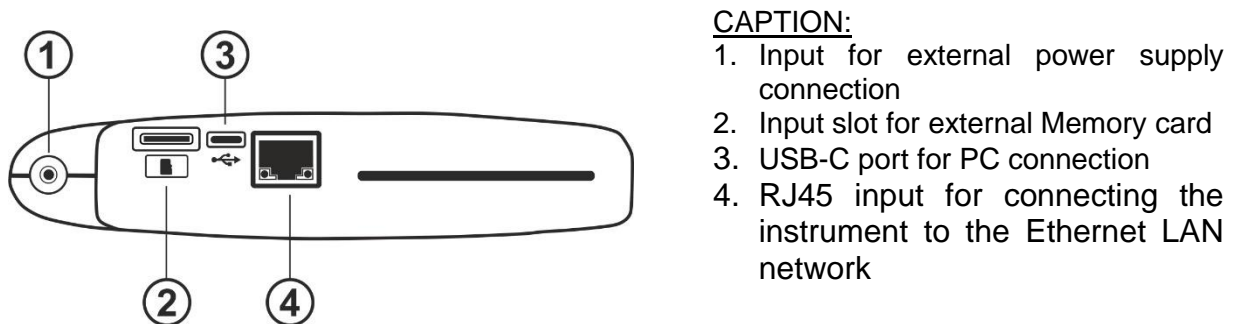

Fig. 3: Description of instrument side connectors

## 4.2. DESCRIPTION OF FUNCTION KEYS

The description of the function keys on the instrument is given below.

| Function key   | Description  |
|----------------|--|
| ON/OFF         | Press <b>ON/OFF</b> key and release it <b>after approx 1s</b> to turn on the instrument. To turn off the instrument keep the key pressed for <b>approx 2s</b> . If the instrument locks, <b>keep the ON/OFF button pressed</b> for a time between <b>3s</b> and <b>10s</b> to force it off   |
| F1, F2, F3, F4 | Multifunction keys. The function of these keys in the various functions of the instrument is summarised <b>by the symbol displayed at the bottom of the display</b> , next to the key itself   |
| ESC            | Key for exiting the various menus and sub-modes. The "X" icon inside the screens performs the same function interactively.   |
| ENTER          | Button with dual function: <ul style="list-style-type: none"> <li>➤ Confirmation of the settings made within the menus</li> <li>➤ Activation/deactivation of the "HOLD" function, which allows the value of the parameters measured by the instrument to be set on the display even during recording. The "H" symbol appears/disappears on the display with each press, as shown in the following Fig. 4:</li> </ul> |

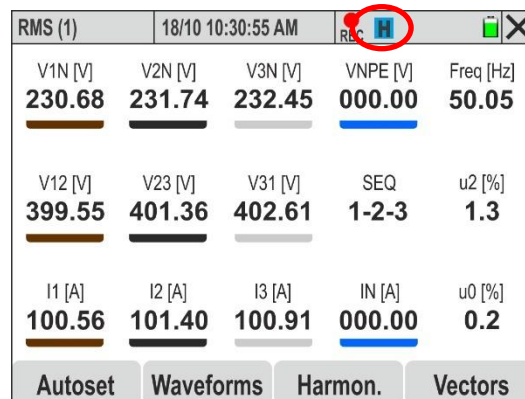
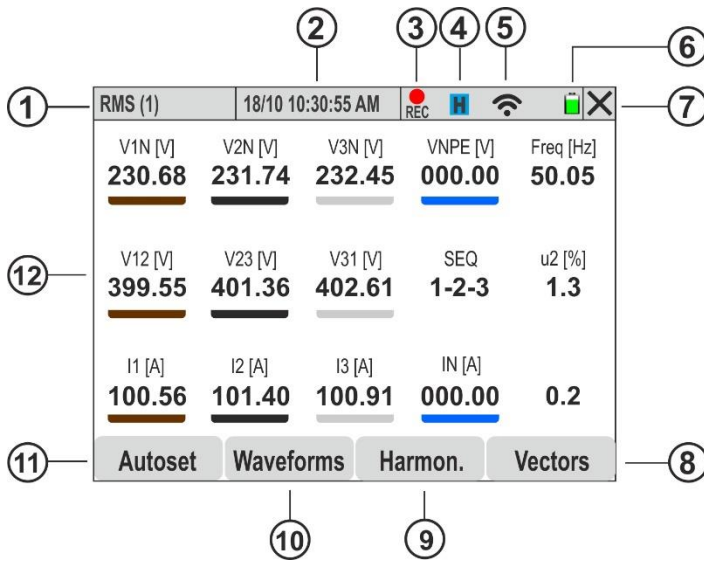

Fig. 4: Activation of the HOLD function

|            |  |
|------------|--|
| ◀, ▲, ▶, ▼ | Use the arrow keys to move the cursor within the various screens in order to select the desired programming parameters. The same keys can also be used to change the scale of the graphs displayed in the multimeter function in Manual mode, in order to improve the resolution of the signal waveform display (see § 5.1.2). <b>The ◀ and ▶ arrow keys can also be used to scroll through the internal pages in the screens where they are available</b> |
| SAVE       | Use this key to save the parameter settings within the menus   |
| GO/STOP    | Manual start/stop of recording (see § 6.3)   |
| HELP       | Activates a contextual help window that provides help on the meaning of the screen currently on the display. The key is active for each function   |

### 4.3. DISPLAY DESCRIPTION

The display is a 73x57mm (320x240pxl) colour TFT graphic module with resistive "touch-screen" technology, which allows direct interaction using the PT400 pen pointer supplied, inserted into the side of the instrument, or with the fingers (the use of gloves does not affect operation). The reference colours associated with the parameters may vary according to the country selected in the general settings, depending on the colour of the test leads used (see § 5.1.2)



**CAPTION:**

1. Parameters displayed in the screen and type of system selected
2. System date/time set
3. Measurement in progress indication
4. HOLD function active
5. WiFi connection active
6. Battery charge level indication
7. Close active window icon
8. Icon to open the screens dedicated to vector diagrams
9. Icon to open the screens dedicated to harmonic analysis
10. Icon to open the screen dedicated to signal waveforms
11. Icon to open the screen dedicated to the control of the Auto-set function
12. Real-time parameter values display area

Fig. 5: Display description

## 5. GENERAL MENU

Each time the instrument is switched on, it automatically displays the "General Menu" screen shown in Fig. 6 below, where the icons can be selected directly by touch or by using the arrow and **ENTER** keys. A blue frame always surrounds the selected icon.

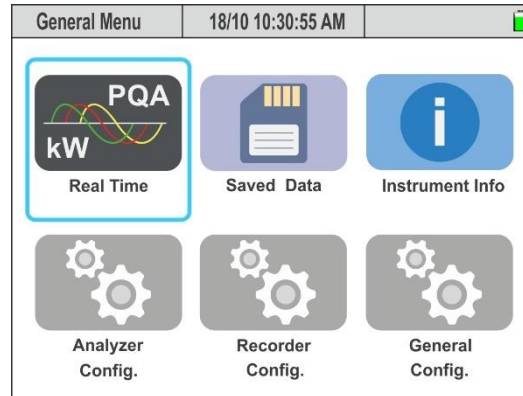

Fig. 6: General Menu Screen

The following icons are present

- **Multimeter** → section showing the results of the measurements in real time (see § 5.4)
- **Saved Data** → section listing all recordings saved in the instrument memory (see § 6.4)
- **Instrument Info** → section with general information about the instrument (see § 6.5)
- **Analyser Config.** → section where you can set the electrical parameters of the instrument and the electrical system in question (see § 5.2)
- **Recorder Config.** → section where you can set the recording parameters (see § 5.3)
- **General Config.** → section where you can set the general parameters of the instrument (see § 5.1)

## 5.1. GENERAL INSTRUMENT SETTINGS

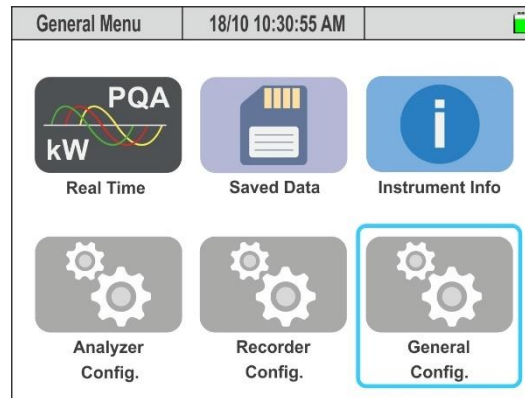

Fig. 7: General Menu Screen – General Settings Section

In this section you can set the following parameters:

- System Language
- System Date/Time
- Display brightness
- Password protection for recordings.
- Sound associated with the keys.
- Auto-off activation/deactivation
- Touch screen display calibration
- Operator name
- Colours associated with the parameters (depending on the selected country)
- Activation/deactivation of the WiFi connection
- Configuration of local Ethernet LAN connection parameters

Press **ENTER** (or touch the relative icon on the display) to enter the "General Settings" menu. The instrument displays the following screens, which can be selected by sliding your finger vertically on the touch-screen

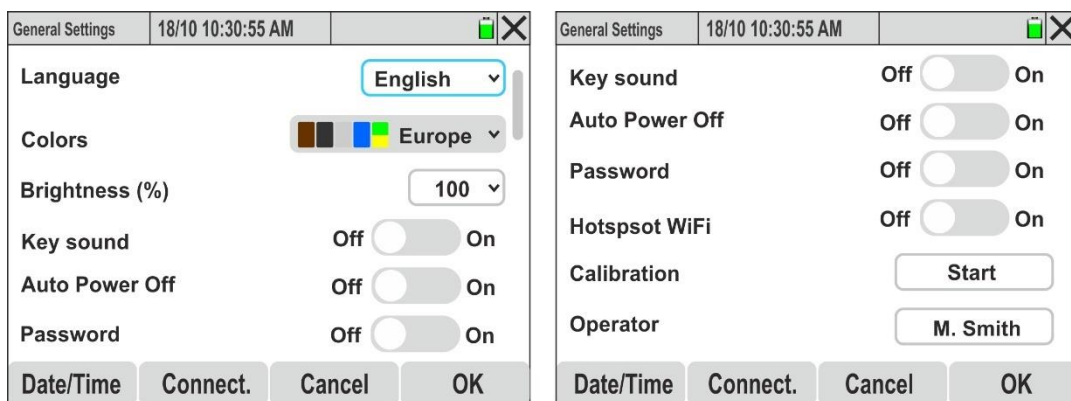

Fig. 8: General Settings Screens

### 5.1.1. Setting the language of the system

1. Open the drop-down menu "∨" corresponding to the "Language" field
2. Select the desired language by choosing from the available options
3. Press **SAVE** or the "OK" virtual key, or the **F4** function key to save the selected setting which will be retained even after the instrument is switched off
4. Touch the "✕" icon, **ESC** key or **F3** key to exit without saving

### 5.1.2. Definition of measuring cable colors and internal parameters

The instrument allows the “color” customization of the connection cables (voltages and current transducers) by mounting the supplied **colored rings** on them, as shown in Fig. 9

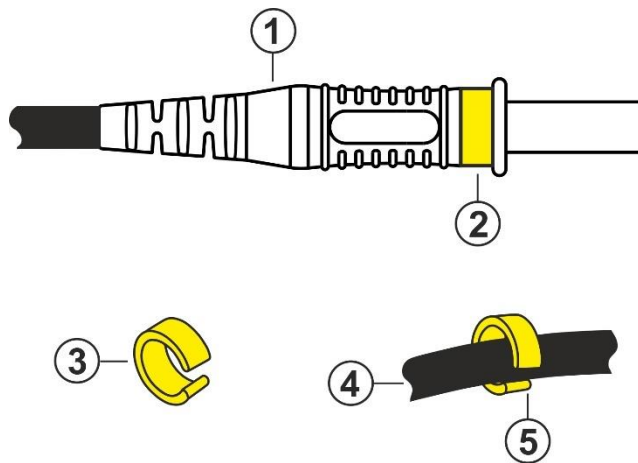

**CAPTION:**

1. Termination of the test cable for voltage measurement
2. Mounting colored ring on the voltage measurement termination
3. Coloured ring with snap-on opening
4. Cable of transducer clamp
5. Mounting the colored ring on cable of clamp transducer

Fig. 9: Mounting colored rings on measuring terminals

Similarly, it is possible to customise the input connector plate (see Fig. 2) by applying a label showing the colours of the cables. An example of the "standard" colours commonly used in various countries is given in the following Table 1. The instrument also allows a similar customisation of the colours used for the electrical quantities displayed in the various measurement screens.

|    | EU, new UK | Old UK, India | AUS, NZL | USA   | Canada | CHN, RUS | JAP   |
|----|------------|---------------|----------|-------|--------|----------|-------|
| L1 | Black      | Red           | Red      | Black | Red    | Yellow   | Black |
| L2 | Black      | Yellow        | White    | Red   | Black  | Green    | Red   |
| L3 | Grey       | Blue          | Blue     | Blue  | Blue   | Red      | Blue  |
| N  | Blue       | Black         | Black    | White | White  | Black    | White |
| E  | Green      | Green         | Green    | Green | Green  | Green    | Green |

Table 1: List of background colours on internal screens

1. Open the drop-down menu "▼" corresponding to the "Colours" field
2. Select the desired country by choosing from the available options. The indication of the colours corresponding to Table 1 is present in the corresponding field
3. Press **SAVE** or the "OK" virtual key, or the **F4** function key to save the selected setting which will be retained even after the instrument is switched off
4. Touch the "✕" icon or the **ESC** key to exit without saving



**CAUTION**

- Use the rings in **KIT802**, supplied as standard, to colour code the cables as required.
- The instrument is supplied with a **neutral** connector side label (see Fig. 2). Apply the label with the desired colour of the cables (according to the country selected) among those available in the **YMETK0042HT0** kit supplied, following the indications given on the neutral one (see Fig. 2 - Part 5)

### 5.1.3. Adjusting the display brightness

1. Open the drop-down menu "▼" corresponding to the field "Brightness (%)"
2. Set the percentage value of the brightness in the field: **0% ÷ 100%**
3. Press **SAVE** or the "OK" virtual key, or the **F4** function key to save the selected setting which will be retained even after the instrument is switched off
4. Touch the "☒" icon or the **ESC** key to exit without saving

### 5.1.4. Setting the key tone

The instrument allows you to associate a short tone with the press of any key on the front panel.

1. Move the virtual selector of the "Key sound" field to "On" to activate or "Off" to deactivate the function
2. Press **SAVE** or the "OK" virtual key, or the **F4** function key to save the selected setting which will be retained even after the instrument is switched off
3. Touch the "☒" icon, **ESC** key or **F3** key to exit without saving

### 5.1.5. Auto Power Off setting

The instrument allows the activation or deactivation of the auto power off function in order to preserve the charge of the internal batteries. If selected, this function is activated when all of the following conditions occur:

- No action is taken (keys, touch, WiFi/Ethernet controls) for about **5 minutes**.
- Instrument not connected to external power pack
- Instrument not measuring

1. Move the virtual selector of the "Auto Power Off" field to "On" to activate or "Off" to deactivate the function
2. Press **SAVE** or the "OK" virtual key, or the **F4** function key to save the selected setting which will be retained even after the instrument is switched off
3. Touch the "☒" icon, **ESC** key or **F3** key to exit without saving

### 5.1.6. Setting the security password

The instrument is equipped with a fixed (**non-changeable**) security password to prevent accidental interruption of a recording in progress.

1. Move the virtual selector of the "Password" field to "On" to activate or "Off" to deactivate the function
2. If this option is selected, when the **GO/STOP** button is pressed, the unit will not stop measuring, but will require the following buttons on the instruments to be pressed in sequence:

|                       |
|-----------------------|
| <b>F1, F4, F3, F2</b> |
|-----------------------|

3. If an incorrect password is entered, the instrument will display the message "Error: Incorrect password" and the operation must be repeated
4. Press **SAVE** or the "OK" virtual key, or the **F4** function key to save the selected setting which will be retained even after the instrument is switched off
5. Touch the "☒" icon, **ESC** key or **F3** key to exit without saving

### 5.1.7. Setting the WiFi Hotspot

The instrument can manage a connection with a PC to download data stored in the memory via a WiFi connection, which can be activated in this section.

1. Move the virtual selector of the "WiFi Hotspot" field to "On" to activate or "Off" to deactivate the function
2. Press **SAVE** or the "OK" virtual key, or the **F4** function key to save the selected setting which will be retained even after the instrument is switched off
3. Touch the "X" icon, **ESC** key or **F3** key to exit without saving
4. Note the presence of the "WiFi" symbol at the top of the window (see Fig. 5 – part 5) to indicate that the WiFi connection is active

### 5.1.8. Touch screen display calibration

This operation may be necessary if some functions within the "touch screen" display are not correctly positioned or cannot be selected with the PT400 pointer

1. Select the "Start" item in the "Calibration" field. The message "Tap top left" appears on the instrument. Touch the top of the screen near the light blue indicator in the left corner (see Fig. 10 – left side)
2. The message " Tap top right" appears on the instrument. Touch the top of the screen near the light blue indicator in the right corner (see Fig. 10 – right side)

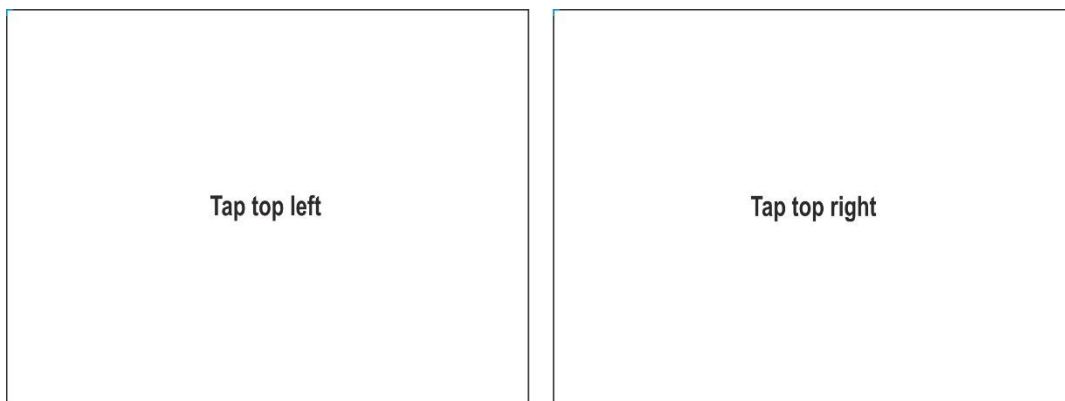

Fig. 10: Touch Screen Calibration Screens – Top part

3. The message "Tap bottom right" appears on the instrument. Touch the bottom of the screen near the light blue indicator on the right corner (see Fig. 11 – left part)

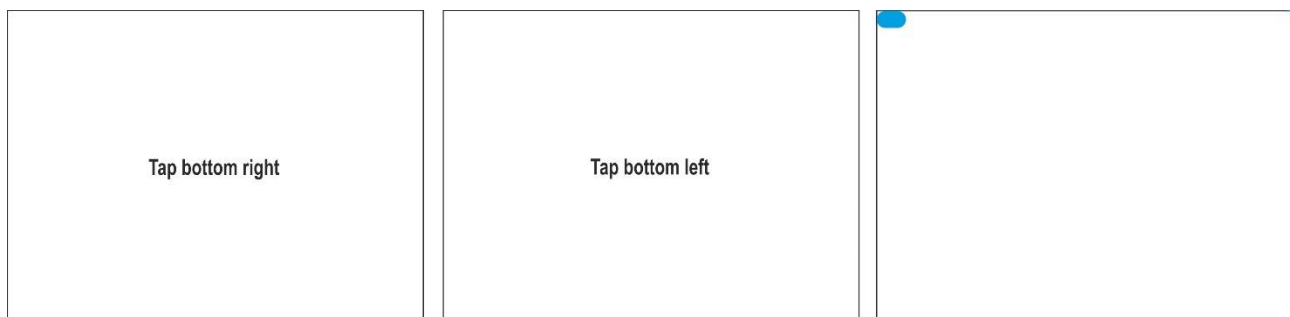

Fig. 11: Touch screen calibration screens – Bottom part

4. The message "Tap bottom left" appears on the instrument. Touch the bottom of the screen near the light blue indicator in the left corner (see Fig. 11 – middle part)
5. When the operations are finished, the instrument displays the screen in Fig. 11- right side
6. Touch the light blue indicator in the top left corner to complete the operation and return to the general menu screen



### 5.1.9. Setting the operator's name

This option allows entering the name of the operator who performs the measurements with the instrument. This name will be included in the reports created using the management software.

1. Touch the corresponding field in the "Operator" section. The following screen will be displayed



Fig. 12: Setting the operator's name

2. Use the internal virtual alphanumeric keyboard to set the operator's name (**max 23 characters**) and confirm the operation by touching the "✓" symbol
3. Press **SAVE** or the "OK" virtual key, or the **F4** function key to save the selected setting which will be retained even after the instrument is switched off
4. Touch the "✕" icon or the **ESC** key to exit without saving

### 5.1.10. Date/Time Setting

1. Press the **F1** key or touch **Date/Time** on the display. The following screen appears on the display:

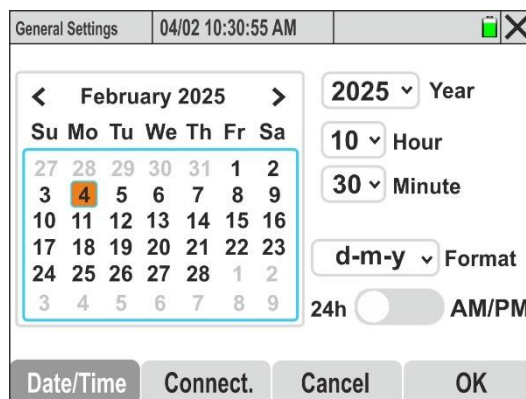

Fig. 13: Date/Time Setting

2. Open the drop-down menu "▼" of the "Year" field and select the appropriate year
3. In the calendar, use the < or > menus to select the reference month and tap the required day, which will be highlighted in orange
4. Open the drop-down menu "▼" to select the "Hours" and the "Minutes" fields and set the system time
5. Open the "▼" drop-down menu to select the "Format" field and select the desired time format from the following options: **d-m-y** (day-month-year), **y-m-d** (year-month-day), **y-d-m** (year-day-month)

6. Move the virtual format selector to the "**24h**" position (24 hour format) or to the "**AM/PM**" position by touching it
7. Press **SAVE** or the "**OK**" virtual key, or the **F4** function key to save the selected setting which will be retained even after the instrument is switched off
8. Touch the "✕" icon, **ESC** key or **F3** key to exit without saving

### 5.1.11. Setting up communication via the Ethernet network

The instrument can be connected to a **local Ethernet LAN network** and consulted by a **PC connected to the same network**.

1. Press the **F2** key or touch **Connect** on the display. The screen of Fig. 14 – left part is shown on the display

#### DHCP mode (recommended)

2. Select the "DHCP" option in the "IP" field if **you do not know in advance the IP address** associated with the internal LAN network
3. Connect the company network cable to the RJ45 input of the instrument (see Fig. 3- part 4) and confirm with "**OK**" or press **F4**
4. **Switch the instrument off and on again.** The IP address assigned to the instrument by the network router will be displayed when returning to the connection section (see Fig. 14 – right side)

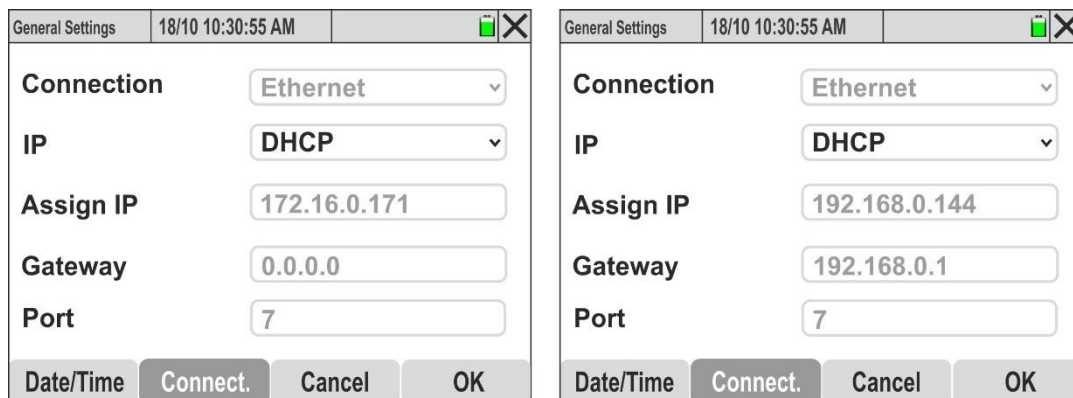

Fig. 14: Setting the Ethernet network communication – DHCP Mode

5. Write down the IP address and return to the general menu by touching "**Cancel**"



### CAUTION

The "Ethernet", "Assign IP", "Gateway" and "Port" fields of the IP address **cannot be edited** in DHCP mode

6. Install the **HTAgorà** software on your PC
7. Click on the "**Preferences**" icon. The following window appears on the display
8. Select the "**Network**" option, enter the IP address of the previously defined device (see Fig. 14 – right side) and press "**OK**" to confirm
9. Carry out the instrument detection and connection procedure as indicated in § 7

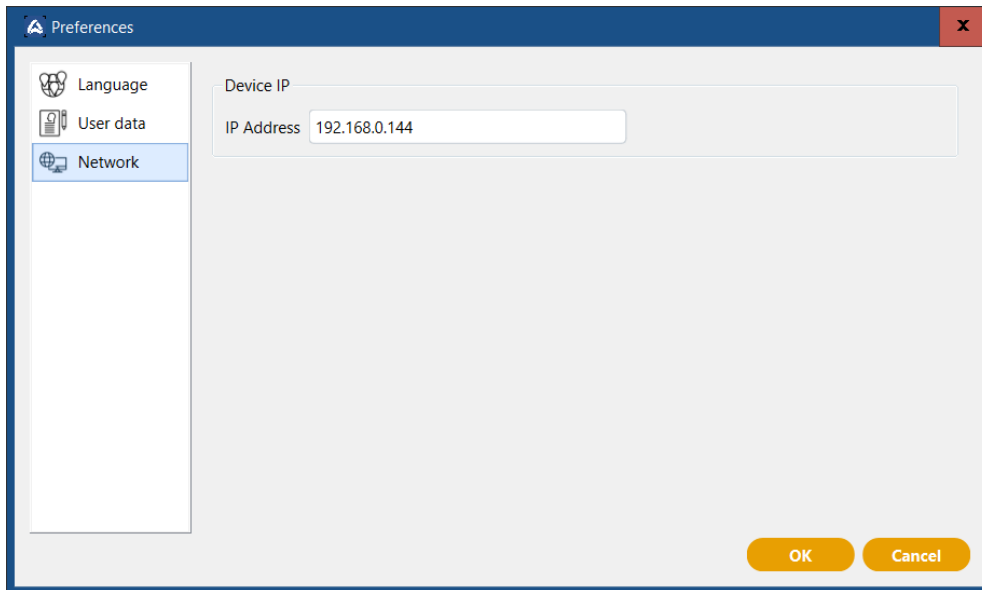

Fig. 15: Setting the IP Address in the HTagorà Software – DHCP Mode

**Static IP Mode**

10. To manually define the LAN network connection parameters, select the "**User defined**" option in the IP field, as shown in

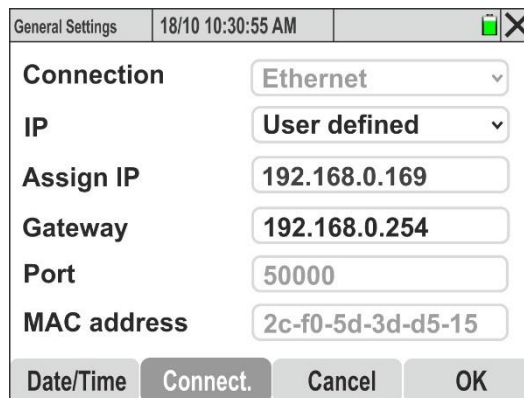

Fig. 16: Setting the communication via Ethernet network – Def. by user Mode

**CAUTION**



- The MAC address is unique to the instrument and clearly cannot be changed
- The number of the port that is used for communication **cannot be changed** and is **50000**
- Instrument - PC communication is possible under the following conditions:
  - Set IP address **not used** by other devices connected to the network
  - The network firewall does not block the communication port and/or IP address set
  - The instrument and the PC **are connected to the same subnet** or to two subnets that can communicate with each other

11. Touch the value associated with the "Assign IP" field. The screen of Fig. 17 – left part is shown on the display

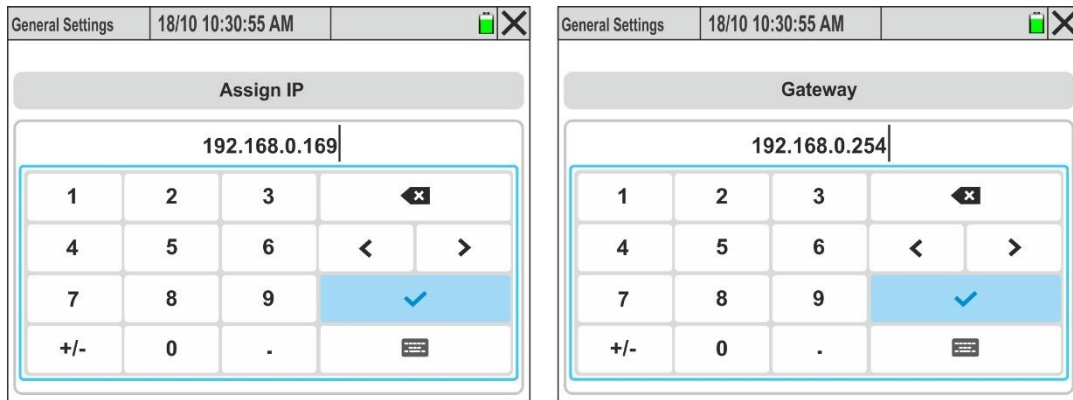

Fig. 17: Setting Ethernet network parameters – User defined Mode

12. Use the virtual keyboard to set the IP address value and confirm the operation by touching the "✓" symbol
13. Touch the value associated with the "Gateway" field. The screen in Fig. 17 – right side is shown on the display
14. Use the virtual keyboard to set the value of the "Gateway" and confirm the operation by touching the "✓" symbol
15. Install the **HTAgorà** software on your PC
16. Click on the "**Preferences**" icon. The following window appears on the display
17. Select the "**Network**" option, enter the IP address of the previously defined device (see Fig. 16) and press "**OK**" to confirm
18. Carry out the instrument detection and connection procedure as indicated in § 7

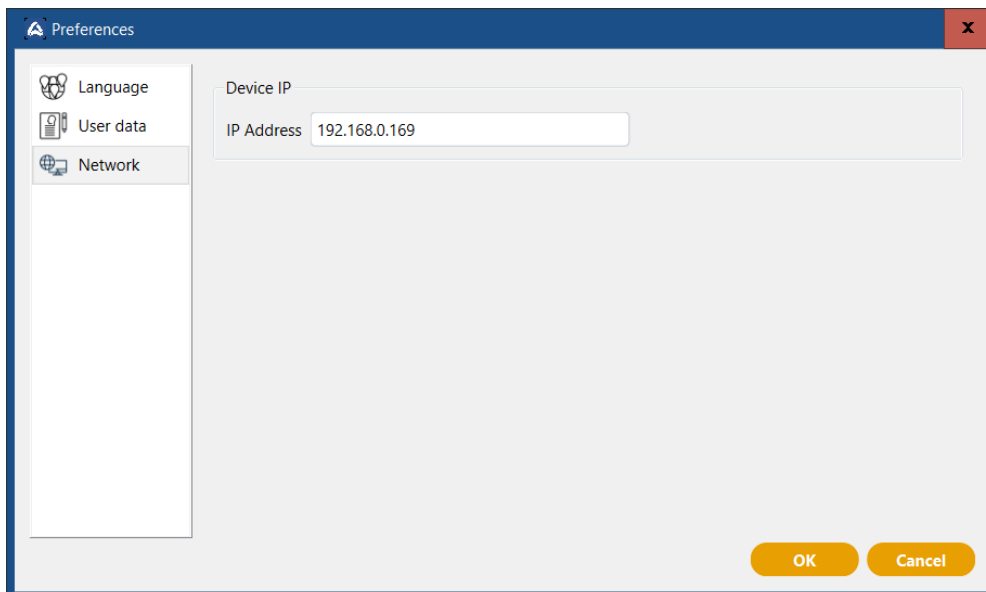

Fig. 18: Setting the IP address in the HTAgorà software – User defined Mode

## 5.2. ANALYSER CONFIGURATION

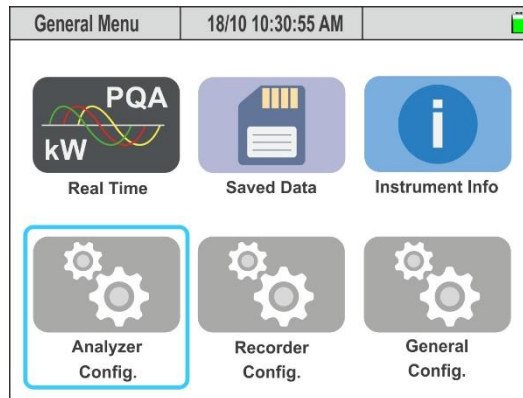

Fig. 19: Analyser Configuration

In this section, the instrument allows making basic and advanced selections in relation to the type of system being tested and the transducers used. In particular, it is possible to select/set:

- The type of system, rated voltage and frequency
- The type of clamp-on transducers for measuring the phase current
- The type of clamp-on transducer for measuring the neutral current
- The full scale of the clamps used for measuring the phase currents
- The full scale of the clamps used for measuring the neutral current
- **In case of connection with external CTs**, the full scale of the primary and secondary TAs present on the phase and neutral conductors
- The transformation ratio in case of connection with external VTs



### CAUTION

The instrument also allows the setting of transducers of different types for phase currents and neutral current

Press **ENTER** (or touch the relative icon on the display) to enter the "Analyser Config." menu. The instrument displays the following screens, which can be selected by sliding your finger vertically on the touch-screen if necessary

### 5.2.1. Setting the type of system, the frequency and the rated voltage

1. Select the "Analyser Config." mode. The instrument displays the following screen (when "Europe" is selected – see § 5.1.2)

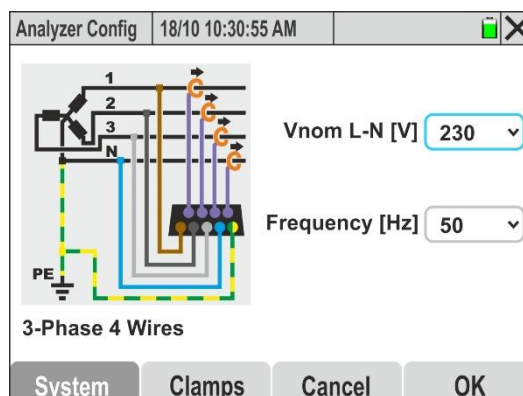

Fig. 20: Setting the type of system, the frequency and the rated voltage

2. **Touch the figure on the screen** to change the type of electrical system to be tested. The instrument cyclically shows the following options:
  - **Single-phase 2 Wires** system (see § 6.1.1)
  - **3-Phase 4 Wires** system (see § 6.1.2)
  - **3-Phase 3 Wires** system (see § 6.1.3)
  - **3-Phase 3 Wires Aron** system (see § 6.1.4)
  - **3-Phase 4 Wires High Leg** system (see § 6.1.5)
  - **3-Phase 3 Wires Open Y** system (see § 6.1.6)
  - **Split Phase 3 Wires** system (see § 6.1.7)
3. Open the drop-down menu "▼" corresponding to the field "Vnom L-N or L-L"
4. Select the system rated voltage value from the options: **100V,105V,110V,115V,120V,125V,127V,150V,190V,200V,208V,216V,220V,230V,240V,250V,277V,346V,380V,400V,415V,433V,440V,480V,575V,690V**. The values available also depend on the type of system selected
5. Open the drop-down menu "▼" corresponding to the "Frequency" field
6. Select the system frequency value from the options: **50Hz, 60Hz**
7. Press **SAVE** or the **"OK"** virtual key, or the **F4** function key to save the selected setting which will be retained even after the instrument is switched off
8. Touch the "✕" icon or the **ESC** key to exit without saving

### 5.2.2. Setting the type of clamp-on transducers

The instrument measures the currents in the following ways:

- Direct measurement with rigid or flexible toroid clamp-on transducers, with a **choice of models** for Phase and Neutral currents
- Measurement on the secondary circuit of current transformers (CTs) **present on the system** with rigid toroid clamp-on transducers (typical application in MV/LV systems)

1. Select the **"Clamps"** item. The display of the instrument shows the following screen, whose entries **may vary** according to the type of system selected

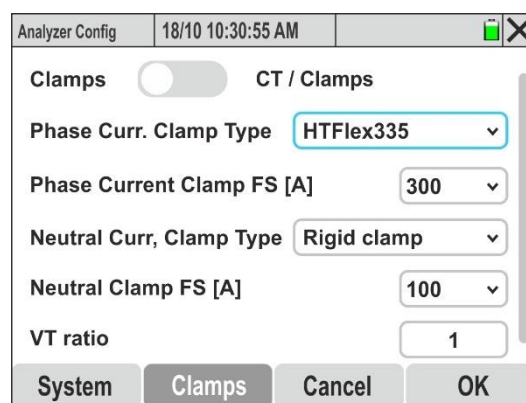

Fig. 21: Current transducer settings and related FS

2. **Move the virtual selector to "Clamps" by touching it** to define the type of clamp to be used for measuring the Phase currents, the (possible) Neutral current and the relative full scale (FS)
3. Open the drop-down menu "▼" corresponding to the "Phase Curr. Clamp Type" and "Neutral Curr. Clamp Type" fields by selecting the type of clamp from the following options:

- **Rigid clamp** standard clamp-on → transducer with rigid toroid (see models in the packing list attached to the instrument) connectable via **ACON3F5M** adapter
  - **HTFlex315** → flexible clamp-on transducer for AC current up to **6000A**, max inner diameter of the toroid **50mm**
  - **HTFlex335** → flexible clamp-on transducer for AC current up to **6000A**, max inner diameter of the toroid **174mm**
  - **HTFlex355** → flexible clamp-on transducer for AC current up to **10000A**, max inner diameter of the toroid **280mm**
4. Open the drop-down menu "▼" corresponding to the "Phase Current Clamp FS" field or the "Neutral Current Clamp FS" field by selecting the full scale value (FS) according to the type of clamp selected in the previous field for measuring the Phase currents and Neutral current. The following values are available:
- **1A, 5A, 10A, 30A, 40A, 100A, 200A, 300A, 400A, 1000A, 2000A, 3000A** → Clamps with rigid toroid
  - **300A, 3000A, 6000A** → HTFlex315, HTFlex335 Flexible clamps
  - **300A, 3000A, 10000A** → HTFlex355 Flexible clamp



**CAUTION**

- If the clamps are equipped with a Full Scale (FS) selector, **to obtain correct measurement results** it is necessary that the FS set on the instrument is **always** the same as that selected on the clamps
- Flexible transducers do not have a physically selectable FS, but the instrument still allows you to set intermediate flow rates to optimise the measurement resolution
- In general, **0.5%FS** should be considered as the **minimum measurable value** for clamp-on transducers, unless otherwise stated in the technical specifications of the instrument

5. Touch the "VT Ratio" field to set the transformation ratio of any voltage transformers (VT) present in the system in question in order to obtain correct readings associated with the primary circuit of the transformers themselves. The following screen will appear on the display:

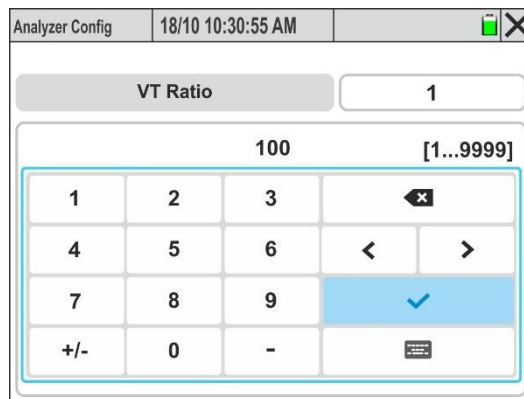

Fig. 22: Setting the external VT transformation ratio

6. Use the virtual keyboard to set the value of the VT transformation ratio and confirm the operation by touching the "✓" symbol. The value must be in the range: **1 ÷ 9999**. The indication **[1...9999]** is shown if you try to set a value outside the range



**CAUTION**

Always leave the default value "1" if there are no VTs in the system to obtain a correct direct measurement of the voltage

7. Press the **SAVE** key or the "OK" virtual key, or the **F4** function key to save the selected settings that remain even after the instrument is switched off
8. Touch the "✕" icon, **ESC** key or **F3** key to exit without saving

**5.2.3. Setting the parameters for current measurement on external CTs**

1. Select the "**Clamps**" item. The display of the instrument shows the following screen, whose entries **may vary** according to the type of system selected. The example of a three-phase four-wire system is shown in Fig. 23

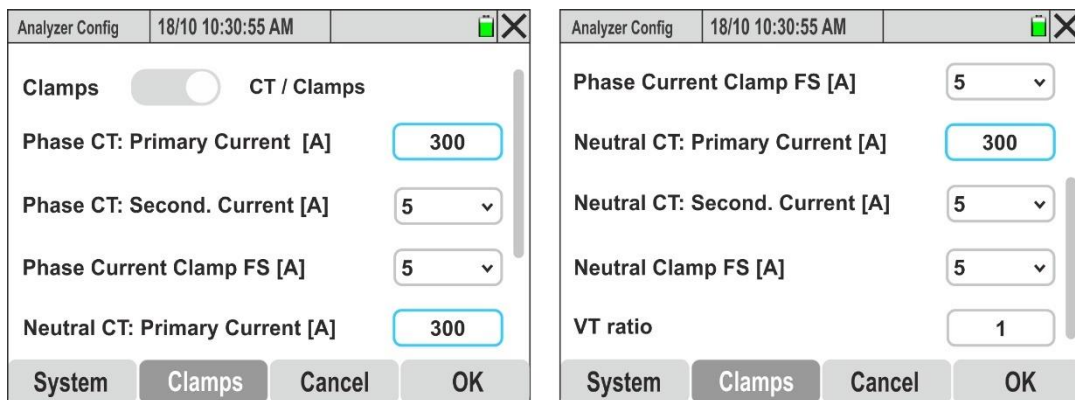

Fig. 23: External CTs current parameter settings (3-phase 4-wire system)

2. Move the virtual selector to the "CT / Clamps" position by touching it to define the currents of the primary and secondary circuits of the CT current transformers, the type of clamp for measuring the Phase and Neutral currents on the secondary CTs and the transformation ratio of any external VTs. For information on connections, see § 10.8
3. Touch the "**Phase CT: Primary Current [A]**" for setting the primary current of the CTs. The following screen will appear on the display:

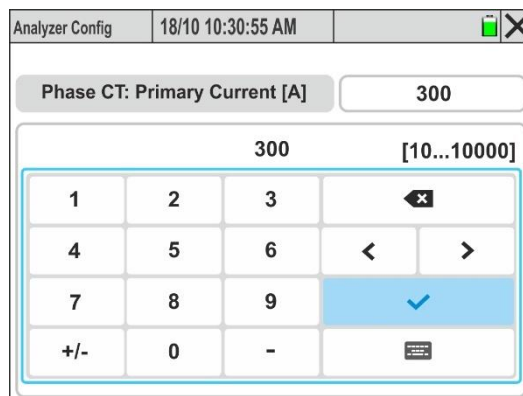

Fig. 24: External CT primary current setting on Phase conductor

4. Use the virtual keypad to set the value of the primary current of the CT and confirm the operation by touching the "✓" symbol. It must be within the range: **10A ÷ 10000A**. The indication **[10...10000]** is shown if you try to set a value outside the range
5. Open the drop-down menu "∨" corresponding to the "**Phase CT: Second. Current [A]**" by selecting from the options: **1A** or **5A** (in the case shown in Fig. 23, a CT with a 300A/5A ratio was set)



6. Open the drop-down menu "✓" corresponding to the "**Phase Current Clamp FS [A]**" field by selecting the FS of the clamp-on transducer with rigid toroid inserted in the secondary circuit of the CT from the options: **1A, 5A, 10A**
7. Touch the "**Neutral CT: Primary Current [A]**" for setting the primary current of the CT on the Neutral conductor. The following screen appears on the display:

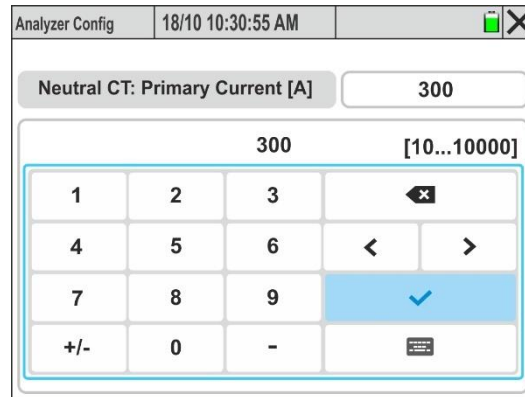

Fig. 25: External CT primary current setting on Neutral conductor

8. Use the virtual keypad to set the value of the primary current of the Neutral CT and confirm the operation by touching the "✓" symbol. It must be within the range: **10A ÷ 10000A**. The indication **[10...10000]** is shown if you try to set a value outside the range
9. Open the drop-down menu "✓" corresponding to the "**Neutral CT: Second. Current [A]**" field by selecting from the options: **1A** or **5A** (in the case shown in Fig. 23, a CT with a 300A/5A ratio was set)
10. Open the drop-down menu "✓" corresponding to the "**Neutral Clamp FS [A]**" by selecting the FS of the clamp-on transducer with rigid toroid inserted in the secondary circuit of the Neutral Current CT from the options: **1A, 5A, 10A**
11. Touch the "**VT ratio**" field to set the transformation ratio of any voltage transformers (VT) present in the system in question in order to obtain correct readings associated with the primary circuit of the transformers themselves. The following screen will appear on the display:

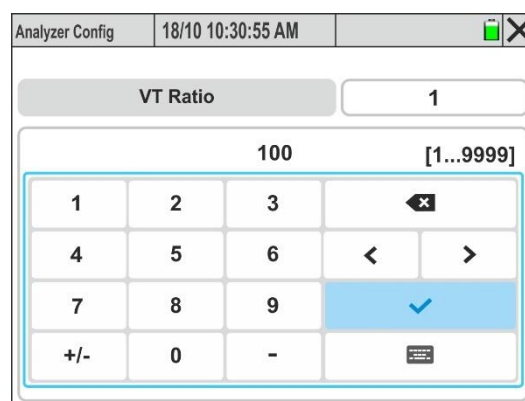

Fig. 26: Setting the external VT transformation ratio

12. Use the virtual keyboard to set the value of the VT transformation ratio and confirm the operation by touching the "✓" symbol. The value must be in the range: **1 ÷ 9999**. The indication **[1...9999]** is shown if you try to set a value outside the range

**CAUTION**

Always leave the default value "1" if there are no VTs in the system to obtain a correct direct measurement of the voltage

13. Press the **SAVE** key or the "**OK**" virtual key, or the **F4** function key to save the selected settings that remain even after the instrument is switched off
14. Touch the "❌" icon, **ESC** key or **F3** key to exit without saving

### 5.3. RECORDER CONFIGURATION

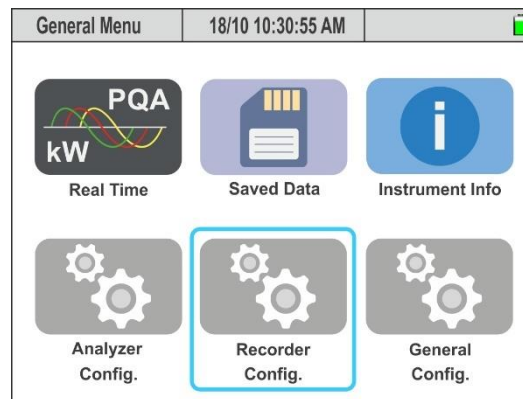

Fig. 27: Recorder configuration

In this section, the instrument allows defining the following operations:

- Insertion of any comments on the recording that will be present in the print report
- Setting of **the main aggregation interval** (time frame between two consecutive saves of the main network parameters within the measuring process)
- Setting of **the Frequency aggregation interval** (time frame between two consecutive saves of the Frequency parameter within the measuring campaign)
- Setting of the **Harmonics parameter aggregation interval** (time frame between two consecutive saves of the Voltages/Currents harmonic analysis parameter within the measuring campaign)
- Measurement start and stop settings
- Activation/deactivation of advanced analyses (Harmonics, Interharmonics, Voltage anomalies, Fast transients, Inrush and Flicker currents)
- Use of predefined configurations that allow selecting only some parameters in order to increase the measuring autonomy

#### CAUTION



- The instrument **always** records **all** the system parameters (**max 3180**) **without the possibility of de-selecting them individually**
- Recording autonomy is automatically calculated by the instrument and **shown on the display in the top left hand corner** according to the aggregation intervals set and the advanced analysis selections. This value **varies dynamically according** to the programming of the aggregation intervals or the use of predefined configurations
- The main parameter, Frequency and Harmonic analysis recordings **use separate and independent aggregation intervals**
- Use predefined configurations and disable advanced analyses to increase measuring autonomy
- It is not possible to change the recording parameters if a recording is already in progress

Press **ENTER** (or touch the relative icon on the display) to enter the "Recorder Settings" menu. The instrument displays the following screens, which can be selected by sliding your finger vertically on the touch-screen if necessary.

### 5.3.1. Setting the recording parameters

1. Select the "Recording Config." mode. The instrument will show the screen in Fig. 28 – left part

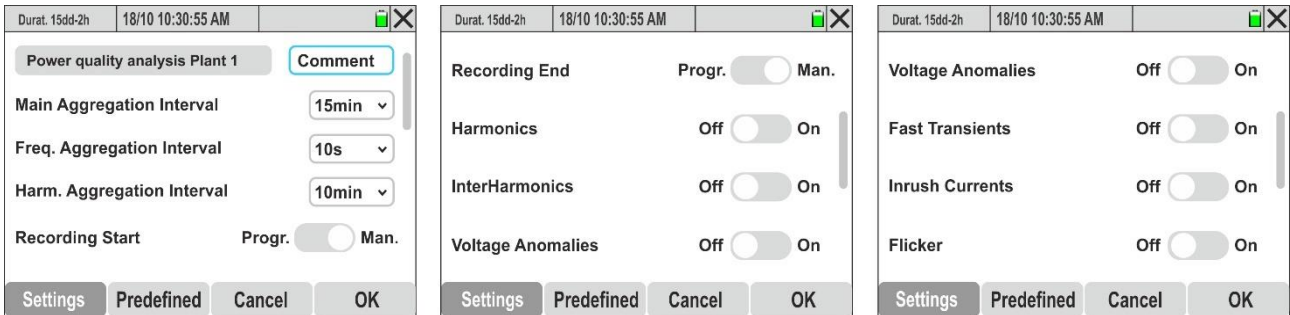

Fig. 28: Recording unit settings screen

2. Touch the "Settings" menu to access the screens for setting the recording parameters
3. Touch the "Comment" field to enter a custom comment that will also appear in the print report downloaded to the PC by the instrument. The following screen will be displayed:

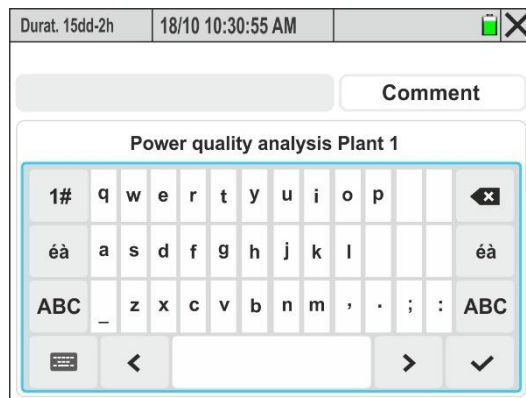

Fig. 29: Setting comment on recording

4. Use the internal virtual alphanumeric keyboard to define the comment (**max 60 characters**) and confirm the operation by touching the "✓" symbol
5. Open the drop-down menu "✓" corresponding to the field "Main Aggregation Interval"
6. Select the main aggregation range (relative to the quantities (voltages, currents, powers, power factors, energies) from the following values: **0.2s, 3s, 10s, 15s, 18s, 30s, 1min, 5min, 10min, 15 min, 30min, 60min,120min**



#### CAUTION

If the **value 0.2s** is selected, only the Average RMS values will be available, while for any value >0.2s the Average, Max and Min values will be available.

7. Open the drop-down menu "✓" corresponding to the field "Freq. Aggregation Interval"
8. Select the Aggregation range between the following values: **1s ÷ 30s** in steps of **1s**
9. Open the drop-down menu "✓" corresponding to the field "Harmonics Aggregation Interval"
10. Select the aggregation range relating to the recording of the values of voltage and current Harmonics between the following values: **0.2s, 3s, 6s, 10s, 12s, 15s, 18s, 30s, 1min, 5min, 10min, 15 min, 30min, 60min,120min**

11. Touch and move the virtual selector of the "Recording Start" field to one of the following positions:

- **Man.** → Manual start of recording with the **GO/STOP** key at the next "00" instant after the key is pressed
- **Progr.** → Programmed start of recording **by pressing the GO/STOP key** to stop the instrument at the date/time set on the instrument. In this state, the screen in Fig. 30-left part of the display is shown



**CAUTION**

- Check that the recording start date/time is **always after** the current date/time
- To set the instrument to wait for the set start date/time, it is still necessary to press **GO/STOP**
- After pressing the **GO/STOP** key, the instrument will display the waiting icon "REC" at the top of the display and then start recording when the set date/time is reached

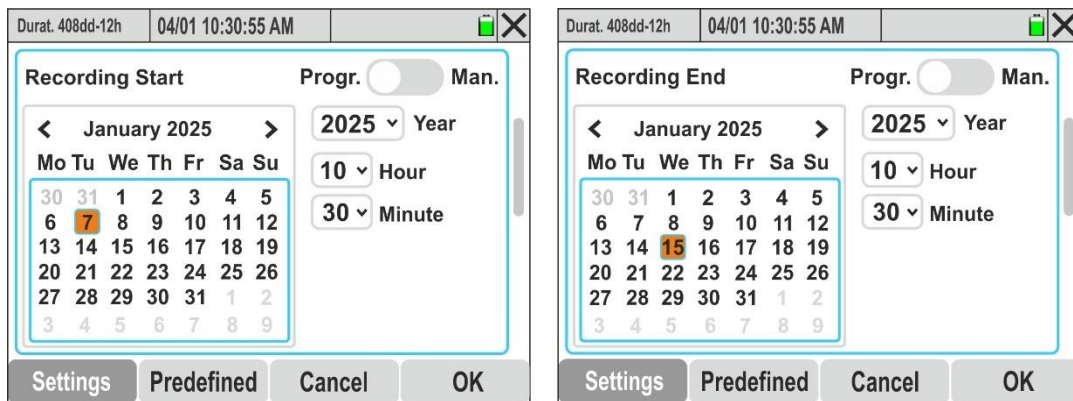

Fig. 30: Setting the programmed recording Start/End date

12. Open the drop-down menu "▼" of the "Year" field and select the appropriate year
13. In the calendar, use the < or > menus to select the reference month and tap the required day, which will be highlighted in orange
14. Open the "Hour" and "Minute" drop down menu "▼" and set the time to start measuring
15. Press **SAVE** or the "OK" virtual key, or the **F4** function key to save the selected setting which will be retained even after the instrument is switched off
16. Touch and move the virtual selector of the "Recording End" field to one of the following positions:

- **Man.** → Manual stop of the recording with the **GO/STOP** key
- **Progr.** → Programmed stop of the recording at the date/time set on the instrument. In this state, the screen in Fig. 30- right part of the display is shown

17. Open the drop-down menu "▼" of the "Year" field and select the appropriate year
18. In the calendar, use the < or > menus to select the reference month and tap the required day, which will be highlighted in orange
19. Open the "Hours" and "Minutes" drop down menu "▼" and the time to stop measuring



**CAUTION**

Check that the recording stop date/time is **always after** the recording start date/time. If not, the instrument will display an error message

20. Touch and move the "**Harmonics**" field virtual selector to "**On**" (activation of harmonic analysis recording) or to "**Off**" (deactivation of harmonic analysis recording). The following screen will appear:

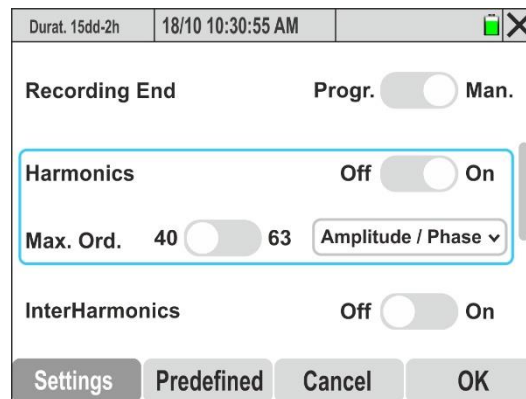

Fig. 31: Activation/deactivation of harmonic analysis parameters recording

21. The following parameters can be selected:

- **Max. Ord.** → Maximum order of voltage and current harmonics (THD%, including DC) recorded by the instrument between the options: **40** or **63**
- Open the drop-down menu "∨" in the field and select the type of parameters recorded by the instrument from the options: "**Amplitude**" (only amplitude of the harmonics in absolute value) and "**Amplitude/Phase**" (complete recording of amplitude and phase of the harmonics)

22. Touch and move the virtual selector in the "**InterHarmonics**" field (harmonics of voltage and current that are **NOT integer multiples** of the fundamental frequency – see §) to 10.2.6 "**On**" (interharmonic recording activation) or to "**Off**" (interharmonic recording deactivation)

23. Touch and move the virtual selector in the "**Voltage Anomalies**" field (see § 10.1) to "**On**" (activation of voltage anomalies recording) or to "**Off**" (deactivation of voltage anomalies recording). The following screen will appear:

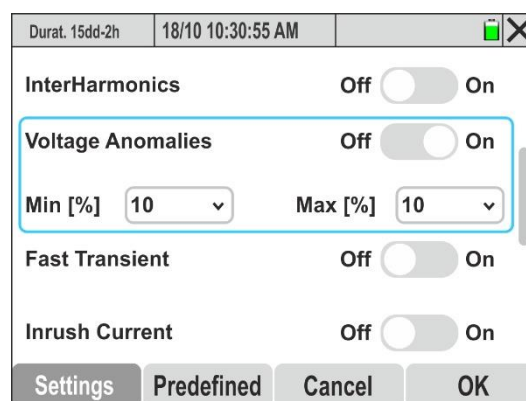

Fig. 32: Activation/deactivation of voltage anomaly recording

- Open the drop-down menu "∨" in the **Min [%]** field to select the **Minimum** percentage value of the voltage with respect to the nominal value of the system (see § 5.2.1) for detecting of sags, voltage interruptions in the field: **1% ÷ 30%** in steps from **1%**
- Open the drop-down menu "∨" in the **Max [%]** field to select the **Maximum** percentage value of the voltage with respect to the nominal value of the system (see § 5.2.1) for detecting voltage peaks in the field: **1% ÷ 30%** in steps from **1%**



**CAUTION**

**The Min and Max values are expressed in % of the Vnom value of § 5.2.1**

24. Touch and move the virtual selector of the "Fast Transient" field (see § 10.6) to "On" (activation of fast voltage transients recording with **minimum resolution 1µs**) or to "Off" (deactivation of fast voltage transients recording). The screen in Fig. 33 is shown on the display

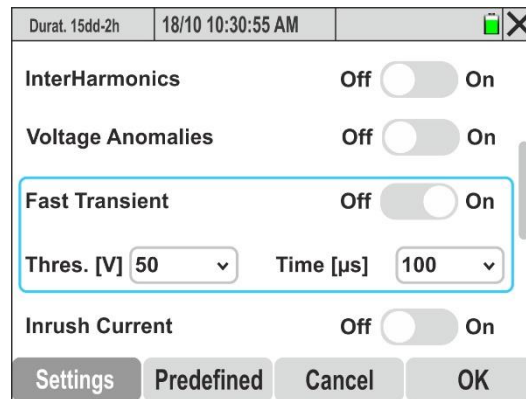

Fig. 33: Activation/deactivation of fast voltage transients recording (spikes)

25. Open the drop-down menu "∨" in the "Thres. [V]" field to set the voltage threshold above which the event is detected and recorded by the instrument within the range: **200V ÷ 8000V** in steps of **50V**

26. Open the drop-down menu "∨" in the "Time [µs]" field to set time detection interval of the event within the range: **100µs ÷ 1000µs** in steps of **100µs**

27. Touch and move the virtual selector of the "Inrush Currents" field (see § 10.3) to "On" (activation of event recording of events related to the inrush currents of the electric machines) or to "Off" (deactivation of inrush current recording). The screen of Fig. 34 – left part is shown on the display

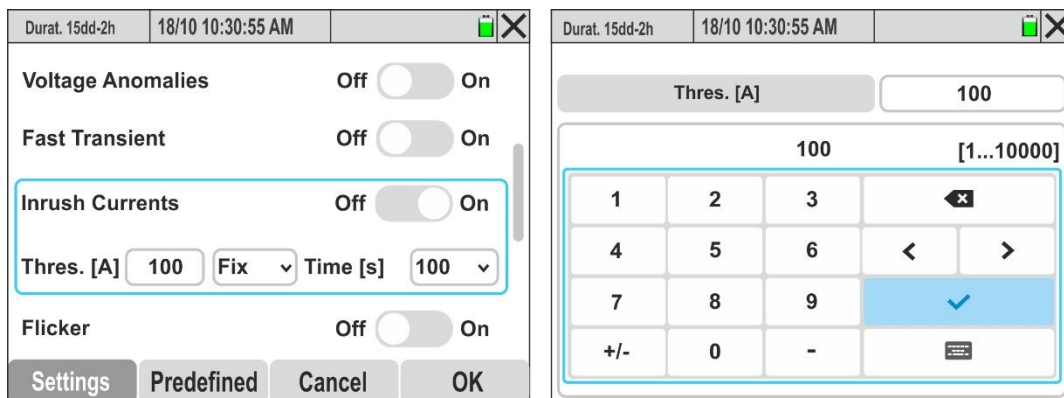

Fig. 34: Activation/deactivation of inrush current recording

28. Touch the "Thres. [A]" field to set the current threshold above which the inrush current event is detected and recorded by the instrument. The screen in Fig. 34 – right side is shown on the display

29. Use the virtual keyboard to set the threshold, which must always be within the range **5% ÷ 95% of the FS value** of the currently selected amperometric transducer.

30. Open the "∨" drop-down menu in the centre field to select the type of inrush current detection. The following options are available: **Fix** (the event is detected when the current threshold is exceeded) or **Var** (the event is detected when the difference between two RMS values calculated over 2 consecutive half-cycles is greater than the threshold)

31. Open the drop-down menu "▼" in the "Time [s]" field to set time detection interval of the event within the range: **0.2s ÷ 10.0s** in steps of **0.2s**
32. Touch and move the virtual selector in the "Flicker" field (recording of the Flicker phenomenon on the input voltages of the instrument in relation to the requirements of the IEC/EN 61000-4-15 standard - see § 10.4) to "On" (Flicker recording activation) or to "Off" (Flicker recording deactivation)"
33. Press **SAVE** or the "OK" virtual key, or the **F4** function key to save the selected setting which will be retained even after the instrument is switched off
34. Touch the "✕" icon or the **ESC** key to exit without saving

### 5.3.2. Setting predefined configurations

In order to provide assistance before starting a recording, the instrument allows the selection of predefined configurations corresponding to typical situations found in industrial electrical systems. The instrument allows to define **2 predefined configurations**, which can be saved and retrieved by the user at any time. By selecting these configurations, **only** the parameters required to perform the recording, or those selected by the user, are automatically set on the instrument. The default configurations are:

1. **Default**: parameters set when the instrument leaves the factory. This configuration **involves measuring ALL the parameters measurable by the instrument**
2. **EN50160**: setting the network quality parameters according to EN50160 for voltage anomalies, voltage harmonic analysis, Flicker and fast voltage transient detection (see § 10.2.2).

1. Select the "Predefined" menu. The instrument will show the followed screen

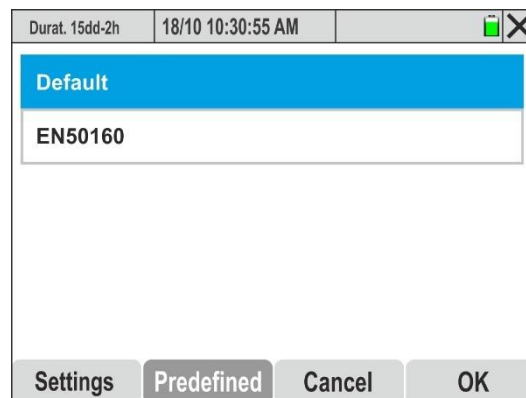

Fig. 35: Default configurations screen

2. Tap on one of the configurations on the display and press "OK" to confirm. The instrument automatically selects only the parameters necessary for the execution of the desired recording and the measuring autonomy.



### 5.4. MULTIMETER FUNCTION

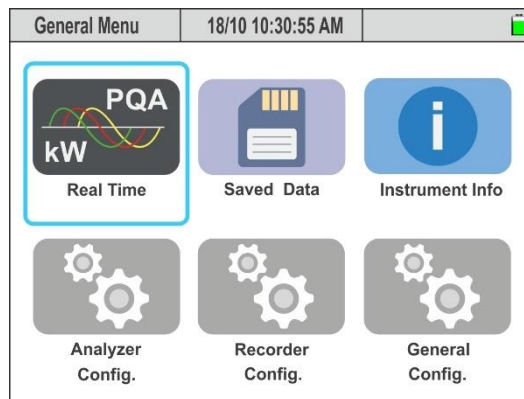

Fig. 36: Multimeter Function

In this section, the instrument displays the values of the measurements made in real time on the input channels and calculated internally with regard to voltages, AC TRMS currents, the set of electrical parameters for each phase and totals, Flicker values, voltage unbalance, display of voltage and current harmonics/interharmonics up to the 63rd order for each phase and totals, display of the vector diagram in which the voltages and currents are shown with their respective offset angles to identify the nature of the loads.

#### 5.1.1. Display of numerical values

The following is a sample screen for a **3-phase 4-wire** system with country = **Europe**. Similar considerations apply to any other recording system and country selected. The type and number of the currently displayed screen is indicated in the top left corner. **The user can view the different screens available by swiping horizontally. The screens are displayed in rotation by swiping the touch screen horizontally (or by using the arrow keys ◀ and ▶).** The number of screens available depends on the type of system considered.

| RMS (1) |           | 18/10 10:30:55 AM |          |           |  |
|---------|-----------|-------------------|----------|-----------|--|
| V1N [V] | V2N [V]   | V3N [V]           | VNPE [V] | Freq [Hz] |  |
| 232.56  | 230.43    | 233.12            | 3.87     | 50.05     |  |
| V12 [V] | V23 [V]   | V31 [V]           | SEQ      | u2% [%]   |  |
| 399.55  | 401.36    | 402.61            | 1-2-3    | 1.3       |  |
| I1 [A]  | I2 [A]    | I3 [A]            | IN [A]   |           |  |
| 100.56  | 101.40    | 100.91            | 15.72    |           |  |
| Autoset | Waveforms | Harmon.           | Vectors  |           |  |

#### PARAMETER KEY

- V1N → Phase-Neutral Voltage Phase L1
- V2N → Phase-Neutral Voltage Phase L2
- V3N → Phase-Neutral Voltage L3
- VNPE → Neutral-PE Voltage
- V12 → Phase L1 - Phase L2 Voltage
- V23 → Phase L2 - Phase L3 Voltage
- V31 → Phase L3 - Phase L1 Voltage
- u2% → % value of voltage dissymmetry
- SEQ → Cyclic phase direction indication:
  - "1-2-3" => Correct
  - "1-3-2" => Incorrect
  - "\*-2-3" => Zero voltage on Phase L1
  - "1-\*-3" => Zero voltage on Phase L2
  - "1-2-\*" => Zero voltage on Phase L3
  - "1-\*-\*" => Zero voltage on Phases L2 and L3
  - "\*-2-\*" => Zero voltage on Phases L1 and L3
  - "\*-\*-3" => Zero voltage on Phases L1 and L2
- Freq → Voltage frequency
- I1 → Current on Phase L1
- I2 → Current on Phase L2
- I3 → Current on Phase L3
- IN → Current on the Neutral conductor

Fig. 37: Page 1/9: Voltage and current numerical values

| RMS (2)                    |                            | 18/10 10:30:55 AM           |                           |
|----------------------------|----------------------------|-----------------------------|---------------------------|
| P1 [kW]                    | P2 [kW]                    | P3 [kW]                     | PT [kW]                   |
| <b>20.35</b>               | <b>20.80</b>               | <b>17.64</b>                | <b>58.79</b>              |
| Q1 [kVAr]                  | Q2 [kVAr]                  | Q3 [kVAr]                   | QT [kVAr]                 |
| <b>11.33</b> $\mathcal{M}$ | <b>10.65</b> $\mathcal{M}$ | <b>-15.56</b> $\mathcal{H}$ | <b>6.42</b> $\mathcal{M}$ |
| S1 [kVA]                   | S2 [kVA]                   | S3 [kVA]                    | ST [kVA]                  |
| <b>23.39</b>               | <b>23.37</b>               | <b>23.52</b>                | <b>59.14</b>              |
| cos $\phi$ 1               | cos $\phi$ 2               | cos $\phi$ 3                | cos $\phi$ T              |
| <b>0.87</b>                | <b>0.89</b>                | <b>0.75</b>                 | <b>0.99</b>               |
| Pf1                        | Pf2                        | Pf3                         | PFT                       |
| <b>0.87</b> $\mathcal{M}$  | <b>0.89</b> $\mathcal{M}$  | <b>0.75</b> $\mathcal{H}$   | <b>0.99</b>               |
| Autoset                    | Waveforms                  | Harmon.                     | Vectors                   |

Fig. 38: Page 2/9: Power values and power factors

**PARAMETER KEY**

P1, P2, P3 → Active power on phases L1, L2, L3  
 PT → Total system active power  
 Q1, Q2, Q3 → Reactive power on phases L1, L2, L3  
 QT → Total system reactive power  
 S1, S2, S3 → Apparent power on phases L1, L2, L3  
 ST → Total apparent system power  
 cos $\phi$ 1, cos $\phi$ 2, cos $\phi$ 3, cos $\phi$ T → Power factor between **voltage and current fundamentals** Phases L1, L2, L3 and total ( $\mathcal{M}$ = inductive load;  $\mathcal{H}$ = capacitive load)  
 Pf1, Pf2, Pf3, PFT → Power factor of Phases L1, L2, L3 and total ( $\mathcal{M}$ = inductive load;  $\mathcal{H}$ = capacitive load)

| RMS (3)                    |                            | 18/10 10:30:55 AM           |                           |
|----------------------------|----------------------------|-----------------------------|---------------------------|
| P1fnd [kW]                 | P2fnd [kW]                 | P3fnd [kW]                  | PTfnd [kW]                |
| <b>19.73</b>               | <b>20.53</b>               | <b>17.30</b>                | <b>57.56</b>              |
| Q1fnd [kVAr]               | Q2fnd [kVAr]               | Q3fnd [kVAr]                | QTfnd [kVAr]              |
| <b>11.18</b> $\mathcal{M}$ | <b>10.52</b> $\mathcal{M}$ | <b>-15.26</b> $\mathcal{H}$ | <b>6.44</b> $\mathcal{M}$ |
| S1fnd [kVA]                | S2fnd [kVA]                | S3fnd [kVA]                 | STfnd [kVA]               |
| <b>22.68</b>               | <b>23.07</b>               | <b>23.07</b>                | <b>57.92</b>              |
| cos $\phi$ 1               | cos $\phi$ 2               | cos $\phi$ 3                | cos $\phi$ T              |
| <b>0.87</b> $\mathcal{M}$  | <b>0.89</b> $\mathcal{M}$  | <b>0.75</b> $\mathcal{H}$   | <b>0.99</b>               |
| Autoset                    | Waveforms                  | Harmon.                     | Vectors                   |

Fig. 39: Page 3/9: Power Values and power factors of U and I fundamentals

**PARAMETER KEY**

P1fnd, P2fnd, P3fnd → Fund. Active **power**. L1, L2, L3 →  
 PTfnd **Total system fund. active power**  
 Q1fnd, Q2fnd, Q3fnd Fund. reactive power → . L1, L2, L3  
 QTfnd → Total system **fund.** reactive power  
 S1fnd, S2fnd, S3fnd → **fund.** apparent power. L1, L2, L3  
 STfnd → Total system **fund.** apparent power  
 cos $\phi$ 1, cos $\phi$ 2, cos $\phi$ 3, cos $\phi$ T → Power Factors between the **voltage and current fundamentals** Phases L1, L2, L3 and total ( $\mathcal{M}$  = inductive load;  $\mathcal{H}$  = capacitive load)

| RMS (4)       |                            | 18/10 10:30:55 AM |                           |
|---------------|----------------------------|-------------------|---------------------------|
| V1N [V]       | THDV1N [%]                 | Pk V1N [V]        | VNPE [V]                  |
| <b>232.56</b> | <b>4.57</b>                | <b>328.89</b>     | <b>3.87</b>               |
| I1 [A]        | THDI1 [%]                  | Pk I1 [A]         | Freq [Hz]                 |
| <b>100.56</b> | <b>45.68</b>               | <b>142.21</b>     | <b>50.05</b>              |
| P1 [kW]       | Q1 [kVAr]                  | S1 [kVA]          | Pf 1                      |
| <b>20.35</b>  | <b>11.33</b> $\mathcal{M}$ | <b>23.39</b>      | <b>0.87</b> $\mathcal{M}$ |
| P1fnd [kW]    | Q1fnd [kVAr]               | S1fnd [kVA]       | cos $\phi$ 1              |
| <b>19.73</b>  | <b>11.18</b> $\mathcal{M}$ | <b>22.68</b>      | <b>0.87</b> $\mathcal{M}$ |
| Autoset       | Waveforms                  | Harmon.           | Vectors                   |

Fig. 40: Page 4/9: Global Values Phase 1

**PARAMETER KEY**

V1N → Phase L1 - Neutral voltage  
 THDV1N → Voltage total harmonic distortion V1N  
 PkV1N → Voltage peak value V1N  
 VNPE → N-PE voltage  
 I1 → Phase L1 current  
 THDI1 → Current total harmonic distortion I1  
 PkI1 → Peak current I1  
 Freq → Voltage frequency  
 P1/Q1/S1 → Active/reactive/apparent power phase L1  
 Pf1 → Phase L1 Power Factor  
 P1fnd → Phase L1 fundamental active power  
 Q1fnd → Phase L1 fundamental reactive power  
 S1fnd → Phase L1 fundamental apparent power  
 cos $\phi$ 1 → Fund.power factor. U and I Phase L1

| RMS (5)       |                            | 18/10 10:30:55 AM |                           |
|---------------|----------------------------|-------------------|---------------------------|
| V2N [V]       | THDV2N [%]                 | Pk V2N [V]        | VNPE [V]                  |
| <b>230.43</b> | <b>3.54</b>                | <b>325.88</b>     | <b>3.87</b>               |
| I2 [A]        | THDI2 [%]                  | Pk I2 [A]         | Freq [Hz]                 |
| <b>101.40</b> | <b>35.67</b>               | <b>143.40</b>     | <b>50.05</b>              |
| P2 [kW]       | Q2 [kVAr]                  | S2 [kVA]          | Pf 2                      |
| <b>20.80</b>  | <b>10.65</b> $\mathcal{M}$ | <b>23.37</b>      | <b>0.89</b> $\mathcal{M}$ |
| P2fnd [kW]    | Q2fnd [kVAr]               | S2fnd [kVA]       | cos $\phi$ 2              |
| <b>20.53</b>  | <b>10.52</b> $\mathcal{M}$ | <b>23.07</b>      | <b>0.89</b> $\mathcal{M}$ |
| Autoset       | Waveforms                  | Harmon.           | Vectors                   |

Fig. 41: Page 5/9: Global Values Phase 2

**PARAMETER KEY:**

V2N → Phase L2 - Neutral voltage  
 THDV2N → Voltage total harmonic distortion V2N  
 PkV2N → Voltage peak value V2N  
 VNPE → N-PE voltage  
 I2 → Phase L2 current  
 THDI2 → Current total harmonic distortion I2  
 PkI2 → Peak current I2  
 Freq → Voltage frequency  
 P2/Q2/S2 → Active/reactive/apparent power phase L2  
 Pf2 → Phase L2 Power Factor  
 P2fnd → Phase L2 fundamental active power  
 Q2fnd → Phase L2 fundamental reactive power  
 S2fnd → Phase L2 fundamental apparent power  
 cos $\phi$ 2 → Fund.power factor. U and I Phase L2

| RMS (6)       |                 | 18/10 10:30:55 AM |               |         |  |         |  |
|---------------|-----------------|-------------------|---------------|---------|--|---------|--|
| V3N [V]       | THDV3N [%]      | Pk V3N [V]        | VNPE [V]      |         |  |         |  |
| <b>233.12</b> | <b>2.56</b>     | <b>329.68</b>     | <b>3.87</b>   |         |  |         |  |
| I3 [A]        | THDI3 [%]       | Pk I3 [A]         | Freq [Hz]     |         |  |         |  |
| <b>100.91</b> | <b>40.23</b>    | <b>142.70</b>     | <b>50.05</b>  |         |  |         |  |
| P3 [kW]       | Q3 [kVAr]       | S3 [kVA]          | Pf3           |         |  |         |  |
| <b>17.64</b>  | <b>-15.56</b> † | <b>23.52</b>      | <b>0.75</b> † |         |  |         |  |
| P3 fnd [kW]   | Q3 fnd [kVAr]   | S3 fnd [kVA]      | cosφ3         |         |  |         |  |
| <b>17.30</b>  | <b>15.26</b> †  | <b>23.07</b>      | <b>0.75</b> † |         |  |         |  |
| Autoset       |                 | Waveforms         |               | Harmon. |  | Vectors |  |

**PARAMETER KEY:**

V3N → Phase L3 - Neutral voltage  
 THDV3N → Voltage total harmonic distortion V3N  
 PkV3N → Voltage peak value V3N  
 VNPE → N-PE voltage  
 I3 → Phase I3 current  
 THDI3 → Current total harmonic distortion I3  
 Freq → Voltage frequency  
 P3/Q3/S3 → Active/reactive/apparent power phase L3  
 Pf3 → Phase L3 Power Factor  
 P3fnd → Phase L3 fundamental active power  
 Q3fnd → Phase L3 fundamental reactive power  
 S3fnd → Phase L3 fundamental apparent power  
 cosφ3 → Fund.power factor. U and I Phase L3

Fig. 42: Page 6/9: Global Values Phase 3

| RMS (7)      |              | 18/10 10:30:55 AM |  |         |  |         |  |
|--------------|--------------|-------------------|--|---------|--|---------|--|
| Pinst V1N    | Pinst V2N    | Pinst V3N         |  |         |  |         |  |
| <b>0.764</b> | <b>0.964</b> | <b>0.456</b>      |  |         |  |         |  |
| Pst V1N      | Pst V2N      | Pst V3N           |  |         |  |         |  |
| <b>0.863</b> | <b>0.967</b> | <b>0.564</b>      |  |         |  |         |  |
| Plt V1N      | Plt V2N      | Plt V3N           |  |         |  |         |  |
| <b>0.000</b> | <b>0.000</b> | <b>0.000</b>      |  |         |  |         |  |
| Autoset      |              | Waveforms         |  | Harmon. |  | Vectors |  |

**PARAMETER KEY:**

Pinst V1N → Instantaneous Flicker value voltage V1N  
 Pinst V2N → Instantaneous Flicker value voltage V2N  
 Pinst V3N → Instantaneous Flicker value voltage V3N  
 Pst V1N → Short Term Flicker Perceptibility voltage V1N  
 Pst V2N → Short Term Flicker Perceptibility voltage V2N  
 Pst V3N → Short Term Flicker Perceptibility voltage V3N  
 Plt V1N → Long Term Flicker Perceptibility voltage V1N  
 Plt V2N → Long Term Flicker Perceptibility voltage V2N  
 Plt V3N → Long Term Flicker Perceptibility voltage V3N

Fig. 43: Page 7/9: Flicker values on input voltages

| RMS (8)      |              | 18/10 10:30:55 AM |              | REC     |  |         |  |  |  |
|--------------|--------------|-------------------|--------------|---------|--|---------|--|--|--|
| Ea1 [kWh]    | Ea2 [kWh]    | Ea3 [kWh]         | EaT [kWh]    |         |  |         |  |  |  |
| <b>5.088</b> | <b>5.200</b> | <b>4.410</b>      | <b>14.70</b> |         |  |         |  |  |  |
| Eri1 [kVArh] | Eri2 [kVArh] | Eri3 [kVArh]      | EriT [kVArh] |         |  |         |  |  |  |
| <b>2.833</b> | <b>2.663</b> | <b>0.000</b>      | <b>5.496</b> |         |  |         |  |  |  |
| Erc1 [kVArh] | Erc2 [kVArh] | Erc3 [kVArh]      | ErcT [kVArh] |         |  |         |  |  |  |
| <b>0.000</b> | <b>0.000</b> | <b>3.890</b>      | <b>3.890</b> |         |  |         |  |  |  |
| PkD1 [kW]    | PkD2 [kW]    | PkD3 [kW]         | PkDT [kW]    |         |  |         |  |  |  |
| <b>22.69</b> | <b>23.57</b> | <b>19.54</b>      | <b>65.80</b> |         |  |         |  |  |  |
| Autoset      |              | Waveforms         |              | Harmon. |  | Vectors |  |  |  |

**PARAMETER KEY:**

Ea1,Ea2,Ea3 → Active energy absorbed L1,L2,L3  
 EaT → Total active energy absorbed  
 Eri1,Eri2,Eri3 → Inductive reactive energy absorbed L1,L2,L3  
 EriT → Total inductive reactive energy absorbed  
 Erc1,Erc2,Erc3 → Capacitive reactive energy absorbed L1,L2,L3  
 ErcT → Total capacitive reactive energy absorbed  
 PkD1 → Absorbed energy peak value phase L1  
 PkD2 → Absorbed energy peak value phase L2  
 PkD3 → Absorbed energy peak value phase L3  
 PkDT → Total absorbed energy peak value

Fig. 44: Page 8/9: Absorbed Energy Values



**CAUTION**

- The values of the energy absorbed by the system are only shown during a recording or at the end of it
- The absorbed energy values are reset when a new recording is started or the instrument is switched off

|                              |                              |                              |                              |  |
|------------------------------|------------------------------|------------------------------|------------------------------|--|
| RMS (9)                      | 18/10 10:30:55 AM            | REC                          |                              |  |
| Ea1 [kWh]<br><b>1.309</b>    | Ea2 [kWh]<br><b>0.867</b>    | Ea3 [kWh]<br><b>0.558</b>    | EaT [kWh]<br><b>2.734</b>    |  |
| Eri1 [kVArh]<br><b>0.000</b> | Eri2 [kVArh]<br><b>0.240</b> | Eri3 [kVArh]<br><b>0.000</b> | EriT [kVArh]<br><b>0.240</b> |  |
| Erc1 [kVArh]<br><b>0.392</b> | Erc2 [kVArh]<br><b>0.000</b> | Erc3 [kVArh]<br><b>0.181</b> | ErcT [kVArh]<br><b>0.573</b> |  |
| PkD1 [kW]<br><b>22.69</b>    | PkD2 [kW]<br><b>23.57</b>    | PkD3 [kW]<br><b>19.54</b>    | PkDT [kW]<br><b>65.80</b>    |  |
| Autoset                      | Waveforms                    | Harmon.                      | Vectors                      |  |

**PARAMETER KEY:**

- Ea1,Ea2,Ea3 → Active energy produced L1,L2,L3
- EaT → Total active energy produced
- Eri1,Eri2,Eri3 → Inductive reactive energy produced L1,L2,L3
- EriT → Total inductive reactive energy produced
- Erc1,Erc2,Erc3 → Capacitive reactive energy produced L1,L2,L3
- ErcT → Total capacitive reactive energy produced
- PkD1 → Produced energy peak value phase L1
- PkD2 → Produced energy peak value phase L2
- PkD3 → Produced energy peak value phase L3
- PkDT → Total produced energy peak value Total

Fig. 45: Page 9/9: Produced energy values



**CAUTION**

- The values of the energy produced by the system **are only shown during a recording or at the end of it**
- The produced energy values **are reset when a new recording is started or the instrument is switched off**

### 5.1.2. Signal waveform display

The following is a sample screen for a **three-phase four-wire** system with country = **Europe**. Similar considerations apply to any other recording system and country selected. The number of screens available depends on the type of system considered.

**In the presence of a page relating to numerical values**, it is possible at any time to select the display of the waveforms of the input voltage and current quantities by pressing the **F2** key or by touching the "**Waveforms**" virtual key. The meaning of the symbols is shown in the figure Fig. 46 below. We **recommend** using the PT400 pen to operate on the waveforms window.

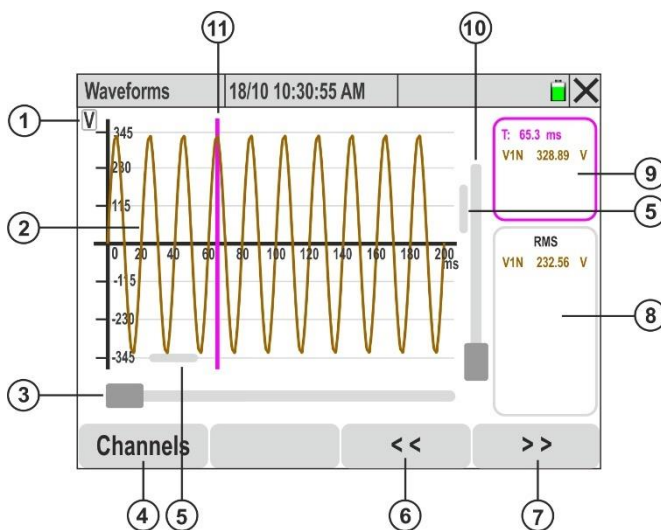

CAPTION:

1. Indication of the quantity shown (**V** = voltage, **A** = current)
2. Waveform of the selected quantity within the "**Channels**" section
3. **Horizontal Zoom** cursor
4. "**Channels**" key for selecting quantities that can be displayed
5. Waveform translation sliders on horizontal and vertical axes
6. Waveform left translation key on the horizontal axis (**only with Zoom active**)
7. Waveform right translation key on the horizontal axis (**only with Zoom active**)
8. Section that displays the TRMS values of the selected quantities
9. Section that displays the instantaneous values of quantities and times axis
10. **Vertical Zoom** cursor
11. Cursor to display the instantaneous values on the chart

Fig. 46: Description of symbols on the waveform screen

**CAUTION**



- The instrument always displays 1024 points for each quantity corresponding to **10 consecutive waveforms** (max 200ms @ 50Hz and (167ms @ 60Hz) (see Fig. 46)
- The default ordinate axis is the one on the left where the FS of the selected voltage or current is shown. The axis of the right ordinate is that of the current when voltage and current are present simultaneously
- The FS shown is automatically adapted by the zoom and/or translation operations performed by the user
- **Touch anywhere on the chart** to show the instant values display fuchsia cursor (see Fig. 46 – part 11). Touch Fig. 46 – part 9 to hide the cursor

**CAUTION**



- **Touch points on the waveform** to move the fuchsia cursor to the desired points by reading the value in Fig. 46 – part 9 . Use the ◀ and ▶ arrow keys to move the cursor along the time axis in 0.1ms increments
- You can select **up to 4 channels simultaneously of the same quantity** (voltage or current) or the **voltage and current of a single phase (V1N&I1, V2N&I2 or V3N&I3)**
- The maximum value of the horizontal Zoom allows the display of **a period** of the waveform of the selected signal
- Use the pen to move the translation sliders (see Fig. 46 – parts 5) to focus on the exact points of the waveform to be examined

1. Touch the "**Channels**" button (see Fig. 46 – part 4). The following screen appears on the display:

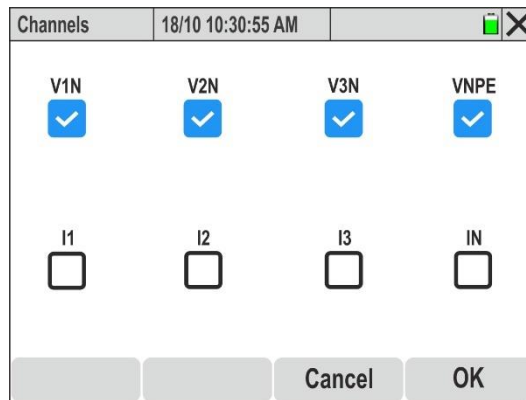

Fig. 47: Channels selection for waveform display

2. Select one of the available options:

- Voltages → **up to 4 signals** simultaneously (V1N, V2N, V3N, VPE)
- Currents → **up to 4 signals** simultaneously (I1, I2, I3, IN)
- Voltages, Currents → **up to 2 signals simultaneously** (V1N&I1 or V2N&I2, or V3N&I3 or VNPE&IN)

3. Press "OK" to confirm or "Cancel" to exit without carrying out any operations. In the latter case, the signal selection remains the same

4. **When the 4 voltages are selected**, the waveforms between the individual phases and the neutral and the voltage between neutral and ground are shown in the following figure:

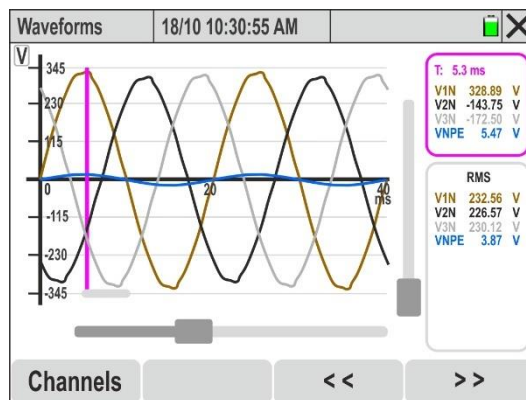

Fig. 48: Display of voltage waveforms

5. **When the 4 currents are selected**, the waveforms of the individual phases and the neutral are shown in the following figure

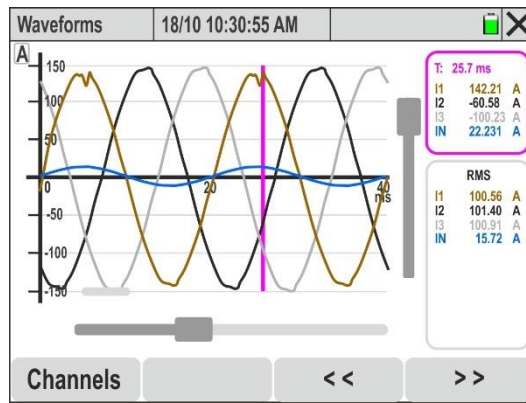

Fig. 49: Display of current waveforms

6. **When the voltages and currents of the individual phases are selected**, the simultaneous waveforms (for example referring to Phase L1) are shown in the following figure:

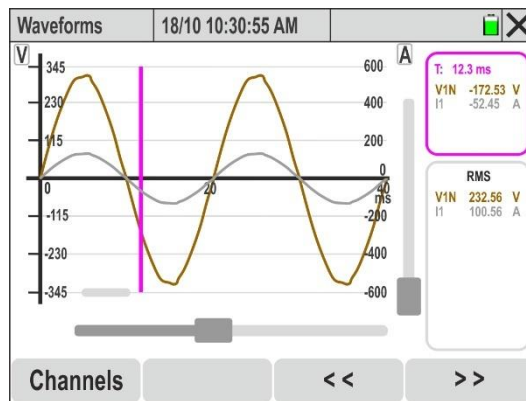

Fig. 50: Display of voltage and current waveforms on Phase L1

7. **Use the horizontal Zoom cursor** (see Fig. 46 – part 3) to expand the waveform on the time axis as shown in Fig. 51 – left part)

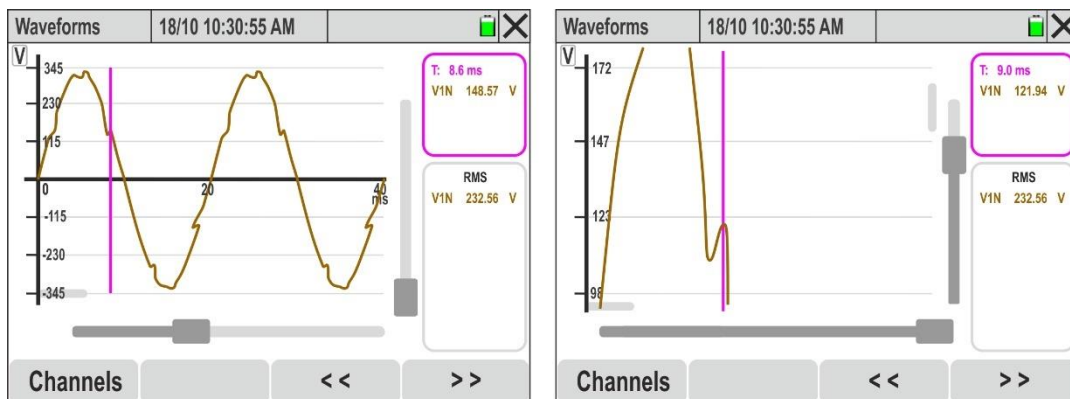
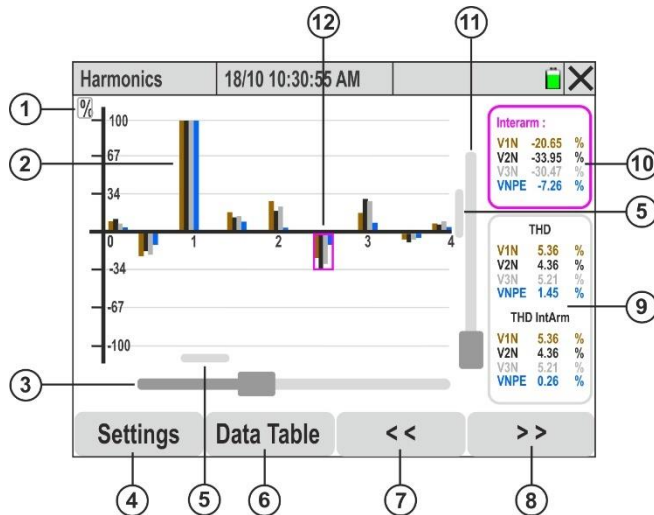

Fig. 51: Display of waveforms with active Zooms

8. **Use the horizontal and vertical Zoom cursors** (see Fig. 46 – parts 3, 10) and the **horizontal and vertical translation cursors** (see Fig. 46 – parts 5) to globally expand the waveform so as to display the desired details as shown in the Fig. 51 – right part)

### 5.1.3. Display of harmonic analysis

In the presence of a page relating to numerical values , it is possible at any time to select the display of the tables and bar graphs of the harmonic analysis of **voltages, currents and powers** by pressing the **F3** key or by touching the "**Harmonic**" virtual key. The meaning of the symbols is shown in the figure Fig. 52 below. We **recommend** using the PT400 pen to operate on the waveforms window. The following are sample screens for a **three-phase four-wire + PE** system with country = **Europe**. Similar considerations apply to any other recording system and country selected. The number of screens available depends on the type of system considered



**CAPTION:**

1. Indication of the quantity shown (**V** = voltage, **A** = current, **W** = power, % = percentage value)
2. Bar graph of the selected quantity in the "**Channel setting**" section.
3. **Horizontal Zoom** cursor
4. "**Setting**" key for selecting the quantities and the viewing mode
5. Graph translation cursors on the horizontal and vertical axes
6. "**Data Table**" button for numerical display of data
7. Left graph translation key on the horizontal axis (**only with Zoom active**) and **harmonic order increment**
8. Right graph translation key on the horizontal axis (**only with Zoom active**) and **harmonic order decrement**
9. Section for displaying values of the THD% parameter relating to the selected quantities
10. Display area for the instantaneous values of the amplitudes or phases of the harmonics selected on the graph
11. **Vertical Zoom** cursor
12. Cursor to display the instantaneous values on the chart

Fig. 52: Description of symbols on the harmonics screen



**CAUTION**

- **Touch the number corresponding to the order of the harmonic** to show the bar graph selection fuchsia cursor and instantaneous values (see Fig. 52 – part 12). Touch Fig. 52 – part 10 to hide the cursor
- Use the ◀ and ▶ arrow keys or the translation keys (see Fig. 52 – parts 7 and 8) to move the fuchsia cursor in the harmonic in the desired order (from DC to 63°)



1. Touch the **"Setting"** button (see Fig. 52 – part 4). The following screen appears on the display:

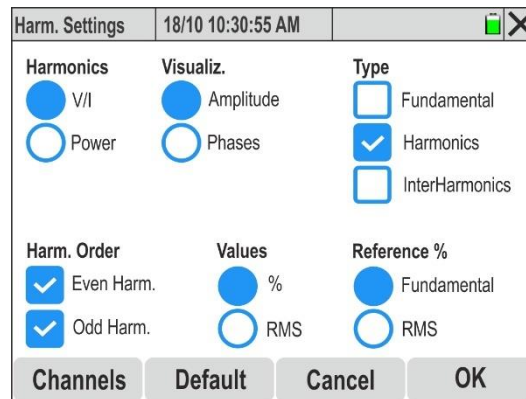

Fig. 53: Select the display setting of the harmonics graphs

2. The following selections are described below:
  - **Harmonics** → display of harmonics **V** and **I** or **Power**
  - **Visualiz.** → display of **Amplitude** or **Phases** of the harmonic
  - **Type** → **Fundamental**, **Harmonics** and **InterHarmonics** display type, also simultaneously
  - **Harm. Order** → display of **Even** or **Odd Harmonics**, also simultaneously
  - **Values** → Display of **percentage (%)** or **absolute (RMS)** values of harmonics
  - **Reference %** → display of the percentage of harmonics, THD% and TID% (interharmonics) in relation to the amplitude of the **fundamental** or to the **RMS** value of the voltage and current quantities
3. Touch the **"Default"** key to reset the default selections present in Fig. 53
4. Press **"OK"** to confirm or **"Cancel"** to exit without carrying out any operations
5. Touch the **"Channels"** key. The following screen will appear on the display:

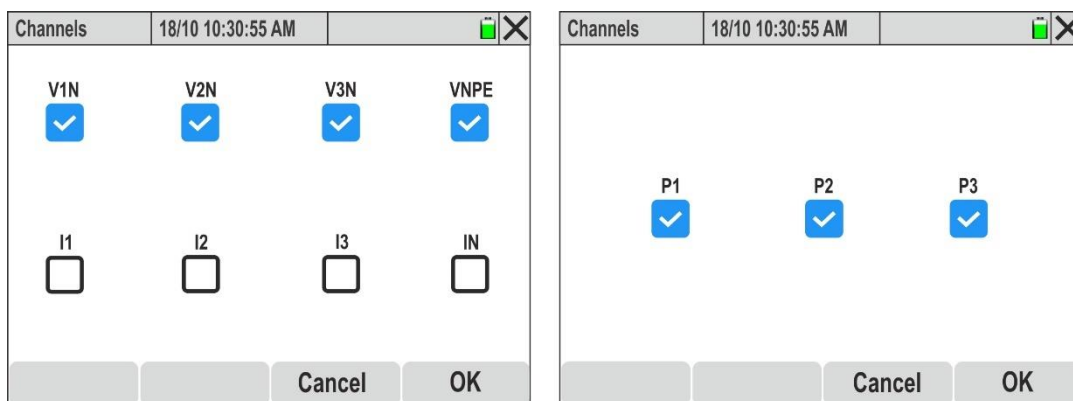

Fig. 54: Selection of channels for displaying harmonic analysis graphs

5. Select one of the available options:
  - Voltages → **up to 4 signals** simultaneously (V1N, V2N, V3N, VPE)
  - Currents → **up to 4 signals** simultaneously (I1, I2, I3, IN)
  - Voltages, Currents → **up to 2 signals simultaneously** (V1N&I1 or V2N&I2, or V3N&I3 or VNPE&IN)
  - Powers → **up to 3 signals** simultaneously (P1, P2, P3)
6. Press **"OK"** to confirm or **"Cancel"** to exit without carrying out any operations. In the latter case, the signal selection remains the same

6. **When the 4 voltages are selected** the bar graphs of the individual voltages V1N, V2N, V3N and VNPE are shown in Fig. 55 - left part

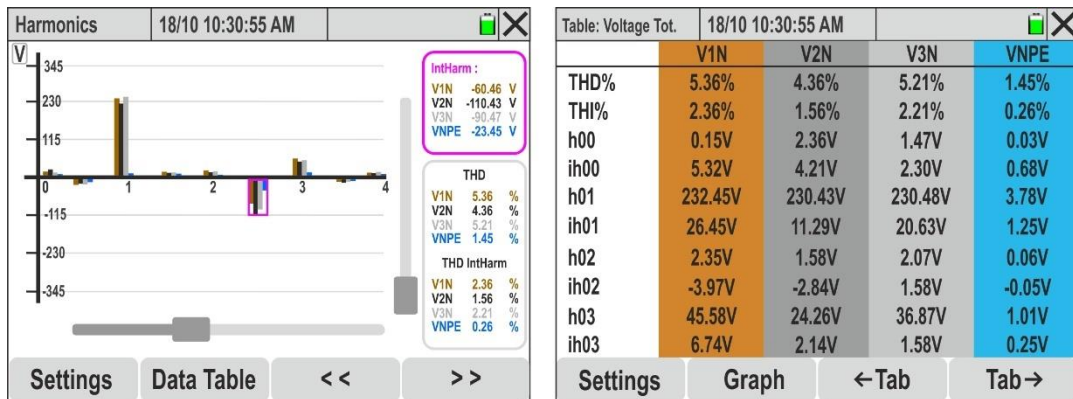

Fig. 55: Harmonic analysis of voltages in numerical format with graph

- The screen displays the amplitudes of the selected harmonics in "%" or "RMS" format and the percentage values of the "THD" (total harmonic distortion) and (with interharmonics enabled) the percentage values of the "THI" (total harmonic distortion of the interharmonics)
- Touch the "Data Table" key to switch from the numeric display. The screen in Fig. 55 – right side is shown on the display. The parameters "hxx" indicate the amplitude of the harmonic xx, while the parameters "ihxx" indicate the amplitude of the interharmonic xx for each selected channel
- Touch the "←Tab" or "Tab→" keys to go to the previous or next page of the parameters, respectively
- When the 4 currents are selected**, the bar graphs of the individual currents I1, I2, I3 and IN are shown in Fig. 56 - left part

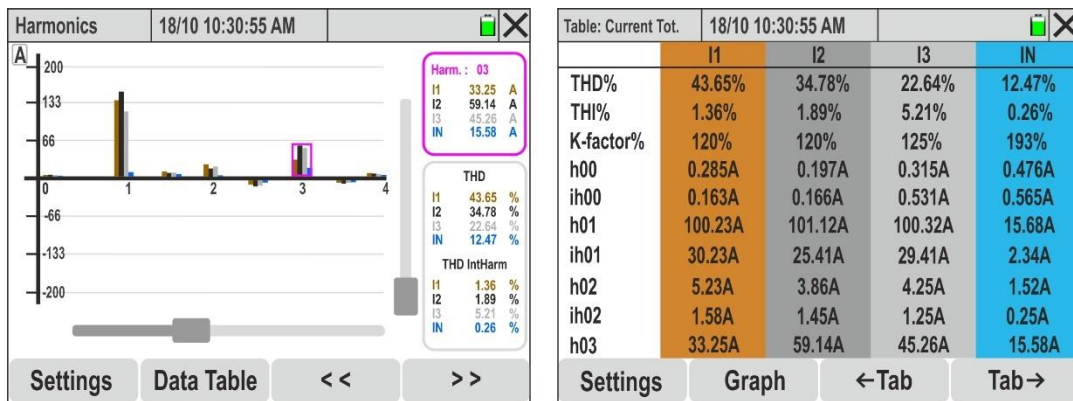

Fig. 56: Current harmonic analysis in numerical format with graph

- The screen displays the amplitudes of the selected harmonics in "%" or "RMS" format and the percentage values of the "THD" (total harmonic distortion of the harmonics), (if selected) the percentage values of the "THI" (total harmonic distortion of the interharmonics) and the percentage values of the "K Factor" (see § 10.2.5)
- Touch the "Data Table" key to switch from the numeric display. The screen in Fig. 55 – right side is shown on the display. The parameters "hxx" indicate the amplitude of the harmonic xx, while the parameters "ihxx" indicate the amplitude of the interharmonic xx for each selected channel
- Touch the "←Tab" or "Tab→" keys to go to the previous or next page of the parameters, respectively

14. **When the voltage and current signals of each phase are selected**, the bar graphs of the pairs V1N&I1, V2N&I2, V3N&I3 or VNPE&IN are shown in Fig. 57

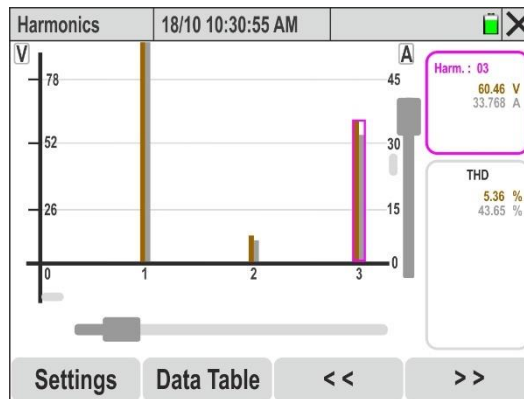

Fig. 57: Harmonic analysis of voltage and current for each phase

15. The screen displays the amplitudes of the voltage and current harmonics selected in "%" or "RMS" format and the percentage values of the "THD" (total harmonic distortion of the harmonics), (if selected) the percentage values of the "THI" (total harmonic distortion of the interharmonics) with different measurement scales for each quantity. Use the vertical/horizontal Zoom tools and the translation bars in order to view the desired values

16. Touch the "Data Table" key to switch from the numeric display. The screen in Fig. 55 – right side is shown on the display. The parameters "hxx" indicate the amplitude of the harmonic xx, while the parameters "ihxx" indicate the amplitude of the interharmonic xx for each selected channel

17. **When the 4 voltages or 4 currents are selected**, the bar graphs of the phase angles with respect to the origin of the quantities V1N, V2N, V3N, VNPE or I1, I2, I3, IN are shown in Fig. 58 – left part

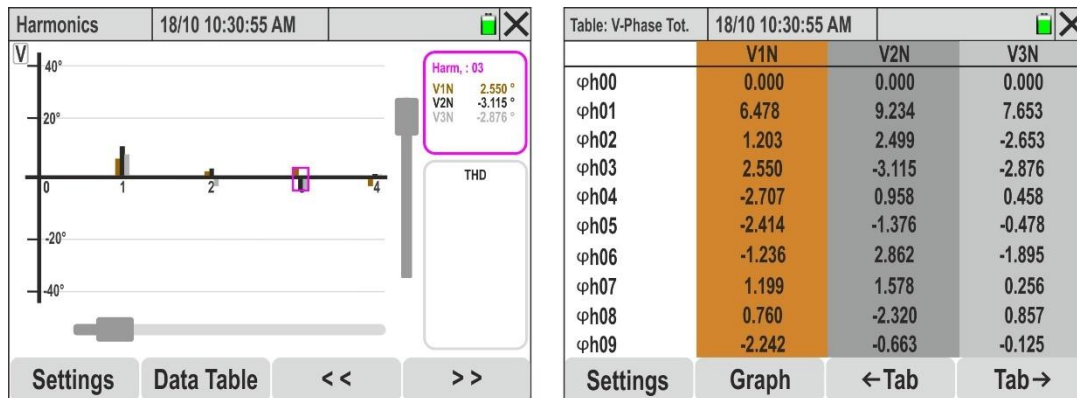

Fig. 58: Phase angle harmonic analysis for voltage signals

18. The screen displays the graphs of the phase angles of the selected voltage harmonics in "%" or "°" format, with different measurement scales for each quantity. Use the vertical/horizontal Zoom tools and the translation bars in order to view the desired values

19. Touch the "Data Table" key to switch from the numeric display. The screen in Fig. 58 – right side is shown on the display. The parameters "φhxx" indicate the amplitude of the harmonic xx, for each selected channel

20. Touch the "←Tab" or "Tab→" keys to go to the previous or next page of the parameters, respectively

21. **When the 3 active powers are selected**, the bar graphs of the quantities P1, P2 and P3 are shown in Fig. 59 – left part

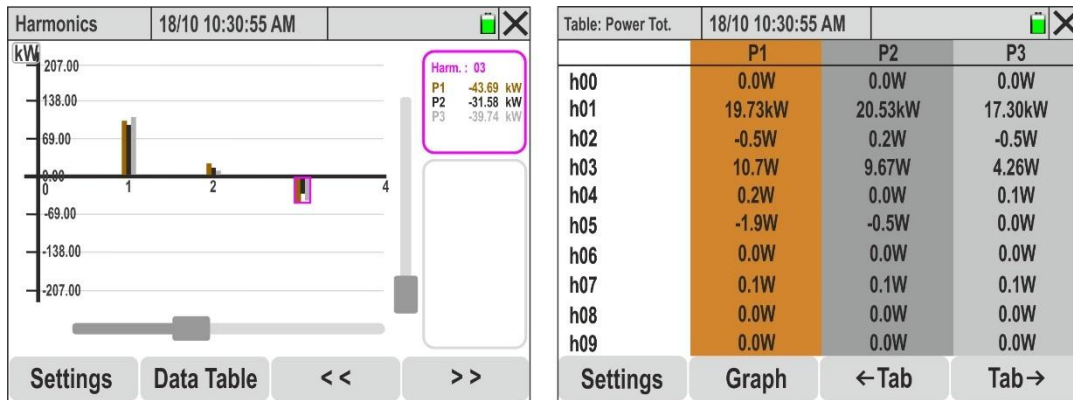

Fig. 59: Harmonic analysis of the active powers

22. The screen displays the graphs of the harmonic amplitudes of the active powers absorbed (positive value) or produced (negative value) selected in "%" or "W" format, with different measurement scales for each quantity. Use the vertical/horizontal Zoom tools and the translation bars in order to view the desired values
23. Touch the "Data Table" key to switch from the numeric display. The screen in Fig. 59 – right side is shown on the display. The parameters "hxx" indicate the amplitude of the power harmonic xx, for each selected channel
24. Touch the "←Tab" or "Tab→" keys to go to the previous or next page of the parameters, respectively

#### 5.1.4. Vectorial diagram display

In the presence of a page relating to numerical values, it is possible to select at any time the display of the **vector diagram of voltages and currents** by pressing the **F4** key or by touching the "**Vectors**" virtual key. The purpose of this function is to display, with graphical and numerical indications, the phase shift angles, expressed in degrees [°], between the voltages V1N, V2N and V3N, the currents I1, I2, I3, IN and the mutual phase shift between each of the voltages and their currents, in order to identify the inductive or capacitive nature of the electrical installation. The meaning of the symbols is shown in the Fig. below. The following are sample screens for a **three-phase four-wire + PE** system with country = **Europe**. Similar considerations apply to any other recording system and country selected. The number of screens available depends on the type of system considered.

1. Touch the "**Channels**" key. The following screen appears on the display:

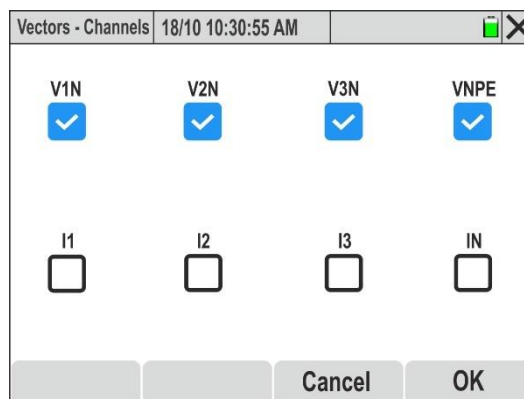

Fig. 60: Channels selection for vectorial diagram display

2. Select one of the available options:

- Voltages → **up to 4 signals** simultaneously (V1N, V2N, V3N, VPE)
- Currents → **up to 4 signals** simultaneously (I1, I2, I3, IN)
- Voltages, Currents → **up to 2 signals simultaneously** (V1N&I1 or V2N&I2, or V3N&I3 or VNPE&IN)

3. Press "OK" to confirm or "Cancel" to exit without carrying out any operations. In the latter case, the signal selection remains the same

4. **When the 4 voltages are displayed**, the vectorial diagram indicating the phasors of the voltages V1N, V2N, V3N with the mutual phase shifts is shown in the following figure:

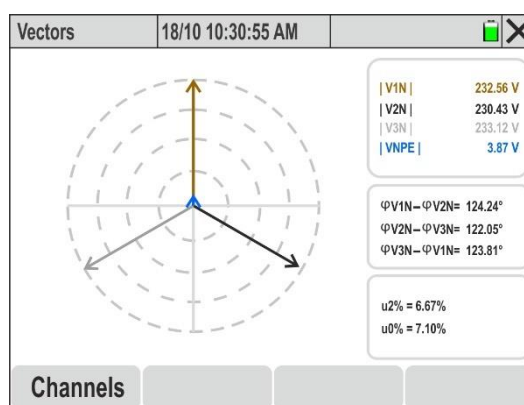

Fig. 61: Vectorial diagram of voltages

5. The following parameters are shown:

- $|V1N|, |V2N|, |V3N|$  → Module amplitudes values of the fundamentals of the voltages V1N, V2N, V3N and VNPE
- $\phi V1N - \phi V2N$  → phase shift between V1N phasor and V2N phasor
- $\phi V2N - \phi V3N$  → phase shift between V2N and V3N phasor
- $\phi V3N - \phi V1N$  → phase shift between V3N phasor and V1N phasor
- $u2\%$  → voltage dissymmetry Inverse and Direct sequence component ratio
- $u0\%$  → voltage dissymmetry Homopolar and Direct sequence component ratio

6. **When the 4 currents are selected**, the vectorial diagram indicating the phasors of currents I1, I2, I3 with the mutual phase shifts is shown in the following figure:

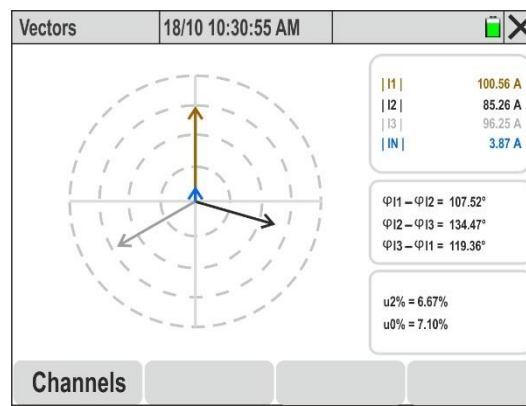

Fig. 62: Vectorial diagram of currents

7. The following parameters are shown:

- $|I1|, |I2|, |I3|, |IN|$  → Module amplitudes of the fundamentals of currents I1, I2, I3 and IN
- $\phi I1 - \phi I2$  → phase shift between I1 phasor and I2 phasor
- $\phi I2 - \phi I3$  → phase shift between I2 phasor and I3 phasor
- $\phi I3 - \phi I1$  → phase shift between I3 phasor and I1 phasor
- $u2\%$  → voltage dissymmetry Inverse and Direct sequence component ratio
- $u0\%$  → voltage dissymmetry Homopolar and Direct sequence component ratio

15. **When the voltage and current signals of each phase are displayed**, the vectorial diagram indicating the phasors of the V1N&I1, V2N&I2 or VN3&I3 pairs with the mutual phase shifts is shown in the following figure

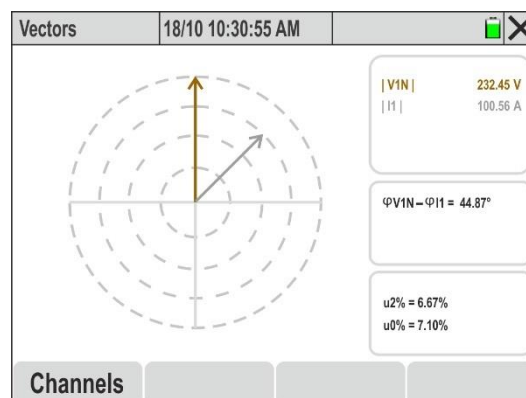

Fig. 63: L1 phase voltage-current vectorial diagram

**CAUTION**

- Vector analysis refers to the polar coordinates (amplitude and phase) of the **fundamental** harmonics ( $h=01$ ) of voltages and currents
- The **voltage** vectors are normalised on the **outermost** circle that is touched by the maximum module of the signal
- If both the voltage and current signals are selected, the current vectors are normalised on the concentric circle **closest to the outermost one** that is touched by the maximum module of the signal
- Each vector is shown with mutual phase shift (**positive rotation direction = anti-clockwise**) with respect to the reference one (**vertical axis =  $0^\circ$** )

## 6. OPERATING INSTRUCTIONS

### 6.1. INSTRUMENT CONNECTIONS TO THE SYSTEM

The following connection diagrams are applicable when **Europe** is selected on the instrument. The figures refer to the accessories supplied with the **KIT802** kit. Refer to Table 1 for ring colours to be inserted on cables associated with other countries.

#### 6.1.1. Single-Phase 2 Wires system



#### CAUTION

The maximum voltage between inputs L1, L2, L3, N and E is 1000V AC CAT IV 600V to earth. Do not measure voltages that exceed the limits indicated in this manual. Exceeding the voltage limits may result in electric shock to the user and damage to the instrument.

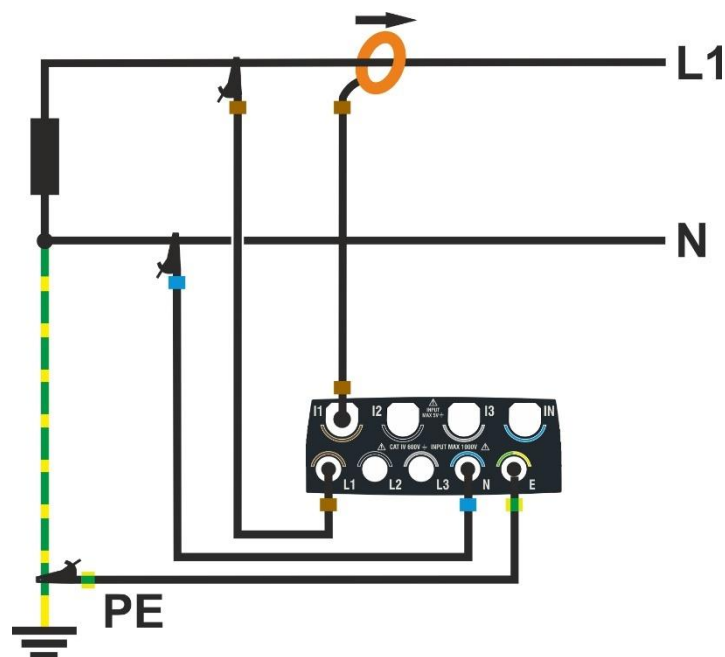

Fig. 64: Connecting the instrument to a Single-Phase 2 Wires system

1. Set the "**Single-Phase 2 Wires**" configuration on the instrument (see § 5.2.1)
2. Connect the voltage cables to the L1, N and PE conductors as shown in Fig. 64
3. Connect the current clamp to the phase L1 conductor **in the direction indicated by the arrow** on the clamp itself, which is the conventional direction of current from the generator to the load
4. Power up the electrical system in question if it has been temporarily shut down to connect the instrument
5. If necessary, use the "**Autoset**" function to check the connections (see § 6.2) **before starting a recording**
6. Press the **GO/STOP** key to start/stop a recording (see § 6.3)



### 6.1.2. Three-Phase 4 Wires system



#### CAUTION

The maximum voltage between inputs L1, L2, L3, N and E is 1000V AC CAT IV 600V to earth. Do not measure voltages that exceed the limits indicated in this manual. Exceeding the voltage limits may result in electric shock to the user and damage to the instrument.

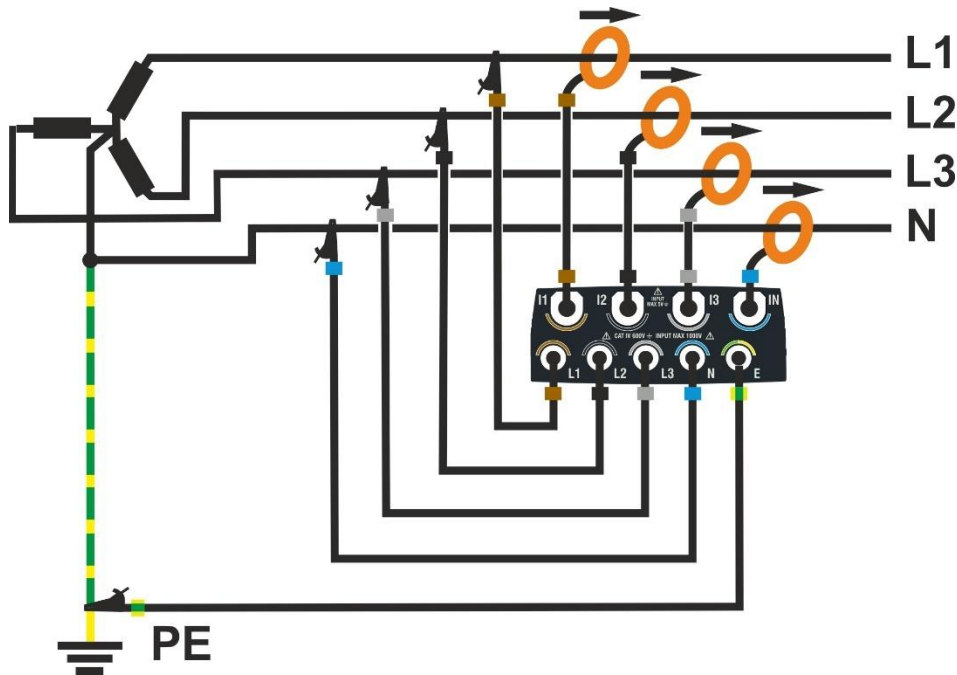

Fig. 65: Connecting the instrument to a Three-Phases 4 Wires system

1. Set the "**3-Phase 4 Wires**" configuration on the instrument (see § 5.2.1)
2. Connect the voltage cables to the L1, L2, L3, N and PE conductors as shown in Fig. 65. **Check that the display shows "1-2-3" for the correct cyclic direction of the phases** (see § 5.1.1)
3. Connect the current clamps to the Phase L1, L2, L3 and N conductors **in the direction indicated by the arrow** on the clamp itself, which is the conventional direction of the current from generator to the load
4. Power up the electrical system in question if it has been temporarily shut down to connect the instrument
5. If necessary, use the "**Autoset**" function to check the connections (see § 6.2) **before starting a recording**
6. Press the **GO/STOP** key to start/stop a recording (see § 6.3)

### 6.1.3. Three-Phases 3 Wires system



#### CAUTION

The maximum voltage between inputs L1, L2, L3 and E is 1000V AC CAT IV 600V to earth. Do not measure voltages that exceed the limits indicated in this manual. Exceeding the voltage limits may result in electric shock to the user and damage to the instrument.

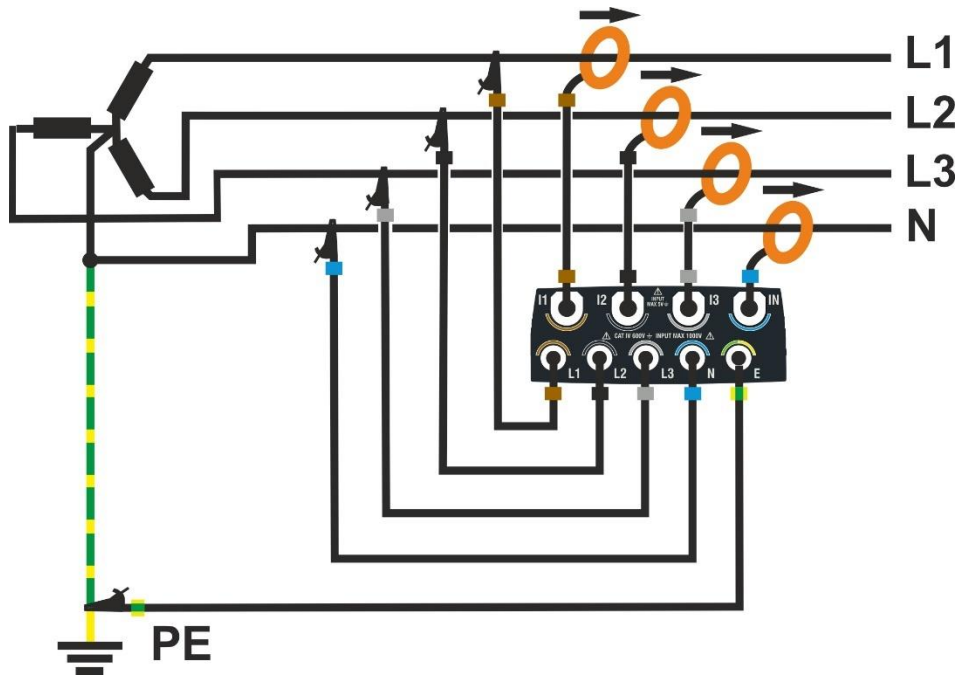

Fig. 66: Connecting the instrument to a Three-Phases 3 Wires system

1. Set the "**3-Phase 3 Wires**" configuration on the instrument (see § 5.2.1)
2. Connect the voltage cables to the L1, L2, L3 and PE conductors as shown in Fig. 66. **Check that the display shows "1-2-3" for the correct cyclic direction of the phases** (see § 5.1.1)
3. Connect the current clamps to the Phase L1, L2, L3 conductors **in the direction indicated by the arrow** on the clamp itself, which is the conventional direction of the current from generator to the load
4. Power up the electrical system in question if it has been temporarily shut down to connect the instrument
5. If necessary, use the "**Autoset**" function to check the connections (see § 6.2) **before starting a recording**
6. Press the **GO/STOP** key to start/stop a recording (see § 6.3)

### 6.1.4. Three-Phase 3 Wires Aron system



#### CAUTION

The maximum voltage between inputs L1, L2, L3 and E is 1000V AC CAT IV 600V to earth. Do not measure voltages that exceed the limits indicated in this manual. Exceeding the voltage limits may result in electric shock to the user and damage to the instrument.

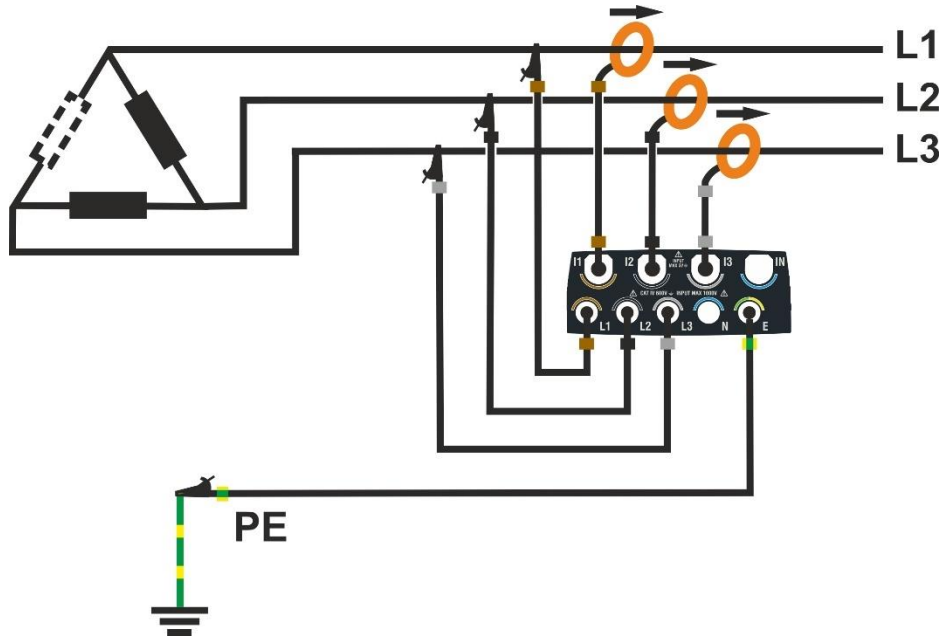

Fig. 67: Connecting the instrument to a Three-Phase 3 Wires Aron system

1. Set the "**3-Phase 3 Wires Aron**" configuration on the instrument (see § 5.2.1)
2. Connect the voltage cables to the L1, L2, L3 and PE conductors as shown in Fig. 67. **Check that the display shows "1-2-3" for the correct cyclic direction of the phases** (see § 5.1.1)
3. Connect the current clamps to the Phase L1, L2, L3 conductors **in the direction indicated by the arrow** on the clamp itself, which is the conventional direction of the current from generator to the load
4. Power up the electrical system in question if it has been temporarily shut down to connect the instrument
5. If necessary, use the "**Autoset**" function to check the connections (see § 6.2) **before starting a recording**
6. Press the **GO/STOP** key to start/stop a recording (see § 6.3)

### 6.1.5. Three-Phase 4 Wires system and 3P HL central socket



#### CAUTION

The maximum voltage between inputs L1, L2, L3, N and E is 1000V AC CAT IV 600V to earth. Do not measure voltages that exceed the limits indicated in this manual. Exceeding the voltage limits may result in electric shock to the user and damage to the instrument.

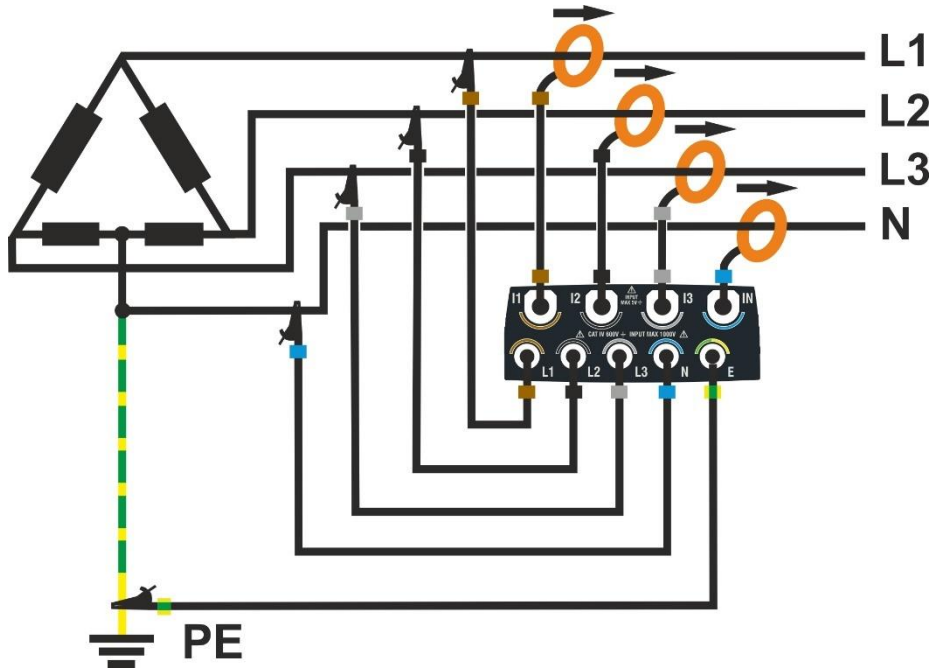

Fig. 68: Connecting the instrument to a Three-Phases 4 Wire 3P HL system

1. Set the "**3-Phase 4 Wires High Leg**" configuration on the instrument (see § 5.2.1)
2. Connect the voltage cables to the L1, L2, L3, N and PE conductors as shown in Fig. 68. **Check that the display shows "1-2-3" for the correct cyclic direction of the phases** (see § 5.1.1)
3. Connect the current clamps to the Phase L1, L2, L3, N conductors **in the direction indicated by the arrow** on the clamp itself, which is the conventional direction of the current from generator to the load
4. Power up the electrical system in question if it has been temporarily shut down to connect the instrument
5. If necessary, use the "**Autoset**" function to check the connections (see § 6.2) **before starting a recording**
6. Press the **GO/STOP** key to start/stop a recording (see § 6.3)

### 6.1.6. Three-Phase 3 Wires system 3P 2E



#### CAUTION

The maximum voltage between inputs L1, L2, L3, N and E is 1000V AC CAT IV 600V to earth. Do not measure voltages that exceed the limits indicated in this manual. Exceeding the voltage limits may result in electric shock to the user and damage to the instrument.

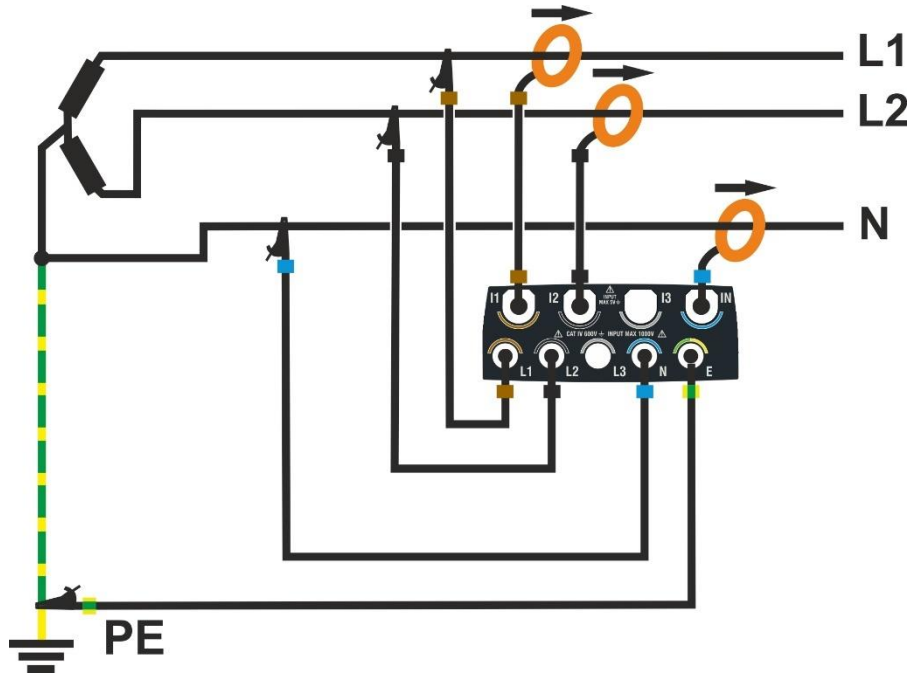

Fig. 69: Connecting the instrument to a Three-Phase 3 Wires system 3P 2E

1. Set the "**3-Phase 3 Wires Open Y**" configuration on the instrument (see § 5.2.1)
2. Connect the voltage cables to the L1, L2, N and PE conductors as shown in Fig. 69
3. Connect the current clamps to the Phase L1, L2, N conductors **in the direction indicated by the arrow** on the clamp itself, which is the conventional direction of the current from generator to the load
4. Power up the electrical system in question if it has been temporarily shut down to connect the instrument
5. If necessary, use the "**Autoset**" function to check the connections (see § 6.2) **before starting a recording**
6. Press the **GO/STOP** key to start/stop a recording (see § 6.3)

### 6.1.7. Split Phase 3 Wires 1P PC system



#### CAUTION

The maximum voltage between inputs L1, L2, L3, N and E is 1000V AC CAT IV 600V to earth. Do not measure voltages that exceed the limits indicated in this manual. Exceeding the voltage limits may result in electric shock to the user and damage to the instrument.

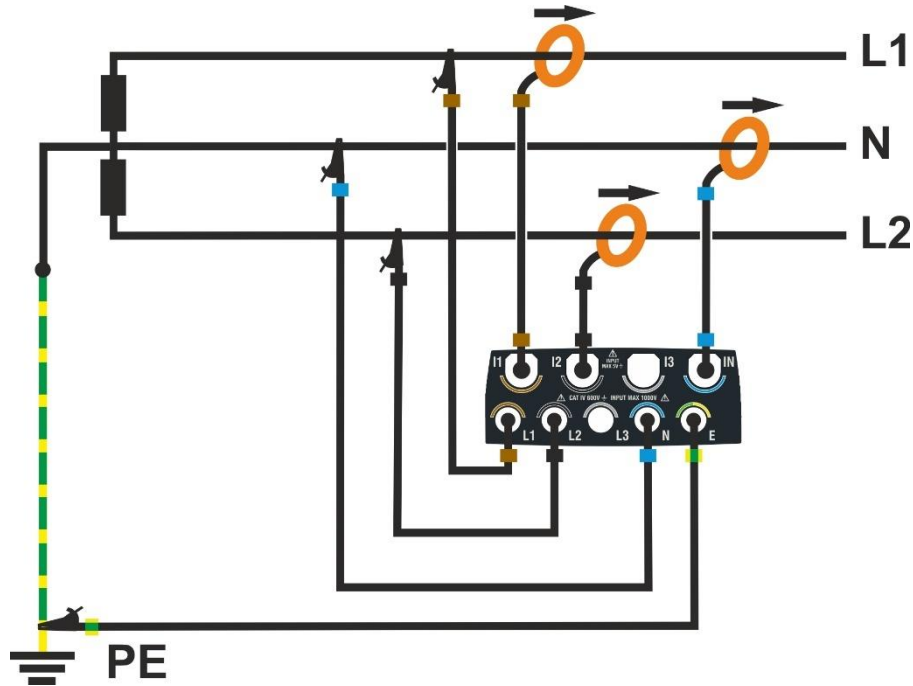

Fig. 70: Connecting the instrument to a Split-Phase 3 Wires 1P PC system

1. Set the "**Split Phase 3 Wires**" configuration on the instrument (see § 5.2.1)
2. Connect the voltage cables to the L1, L2, N and PE conductors as shown in Fig. 70
3. Connect the current clamps to the Phase L1, L2, N conductors **in the direction indicated by the arrow** on the clamp itself, which is the conventional direction of the current from generator to the load
4. Power up the electrical system in question if it has been temporarily shut down to connect the instrument
5. If necessary, use the "**Autoset**" function to check the connections (see § 6.2) **before starting a recording**
6. Press the **GO/STOP** key to start/stop a recording (see § 6.3)

## 6.2. AUTOSSET FUNCTION

It is **recommended** to use the Autoset mode to avoid possible gross connection errors, with the consequent presence of inconsistent values for some electrical quantities, which could lead to the need to repeat the recording. The most common connection errors are those related to the interchanging of clamps on the conductors, resulting in phase differences between the voltage and current signals. This effect is **typically** manifested by incorrect **negative** values of the active powers.



| CAUTION |  |
|---------|--|
|         | <ul style="list-style-type: none"> <li>The Autoset function is <b>only compliance with HTFLEX315 , HTFLEX335, and HTFLEX355 clamps</b></li> <li><b>After an Autoset, the instrument ALWAYS sets the highest FS available for the clamp detected. If it is anticipated to measure currents always lower than 10% of the FS, it is recommended to reset the FS of the clamps (see § 5.2.2) after having performed the Autoset</b></li> <li>The current clamps show an arrow "→" indicating the direction of insertion from "generator" to "load"</li> <li>It is possible to start an Autoset operation only if the instrument is NOT measuring</li> <li>The Autoset function is only compatible with measurements carried out on an electrical system with <b>passive loads</b> (without cogeneration) with a <math>\cos \varphi</math> power factor between <b>0.7i ÷ 0.99c</b>, typical of industrial applications. <b>If the conditions are not verified, the function will not be executed</b></li> <li>Autoset does NOT modify the recording parameters, only those specific to the amperometric transducers</li> <li>At the end of an Autoset, the instrument will have automatically reset the type of amperometric transducers and the association between the voltage and current channels in order to obtain a measurement corresponding to an electrical system with the characteristics indicated above</li> </ul> |

1. Connect the instrument to the system in question (see § 6.1) and carry out the settings indicated in § 5.2.1
2. Touch the "Real Time" icon in the general menu
3. Touch the "Autoset" key. The screen in Fig. 71- left side (relating to a Three-Phase 4 Wires system) is shown on the display

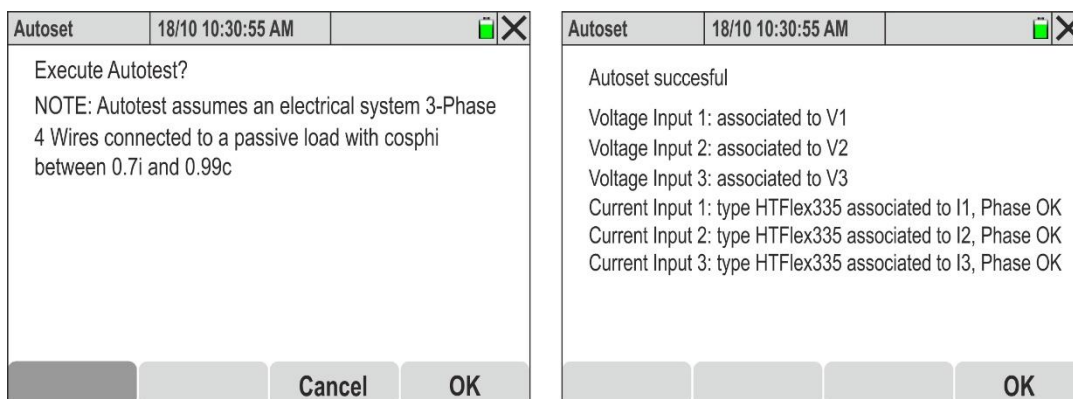

Fig. 71: Autoset execution without connection errors

4. To perform the Autoset function, the instrument requires connection to an electrical system with **passive loads** (without cogeneration) having a  $\cos \varphi$  power factor between **0.7i ÷ 0.99c**, typical of industrial applications. **If the conditions are not verified, the function will not be executed**

5. Touch "OK" to confirm. → The function is executed and after a few moments the screen in Fig. 71 – right side is displayed if the **Autoset is correct**. The following parameters are checked:
  - Voltage on L1 input → associated with V1
  - Voltage on L2 input → associated with V2
  - Voltage on L3 input → associated with V3
  - Current on input I1 → associated with I1, clamp type and voltage phase V1 OK
  - Current on input I2 → associated with I2, clamp type and voltage phase V2 OK
  - Current on input I3 → associated with I3, clamp type and voltage phase V3 OK
6. Touch "OK" to switch to the multimeter function
7. If the Autoset function **detects one or more connection errors**, the following figures show a possible situation:

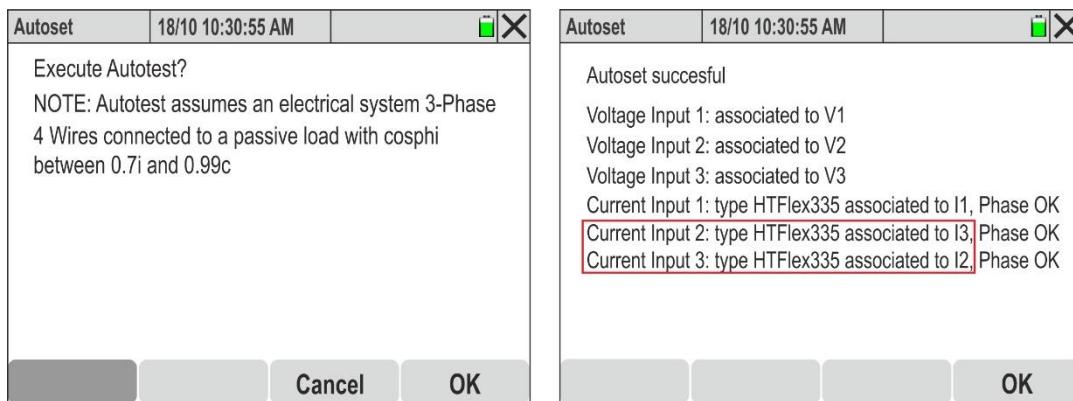

Fig. 72: Autoset execution with connection errors (clamps reversed)

8. The Fig. 72 - right side shows how the Autoset function has detected and **automatically corrected** an incorrect reading on phases L2 and L3 due to the **incorrect connection of the current clamps (clamps 2 and 3 reversed)**

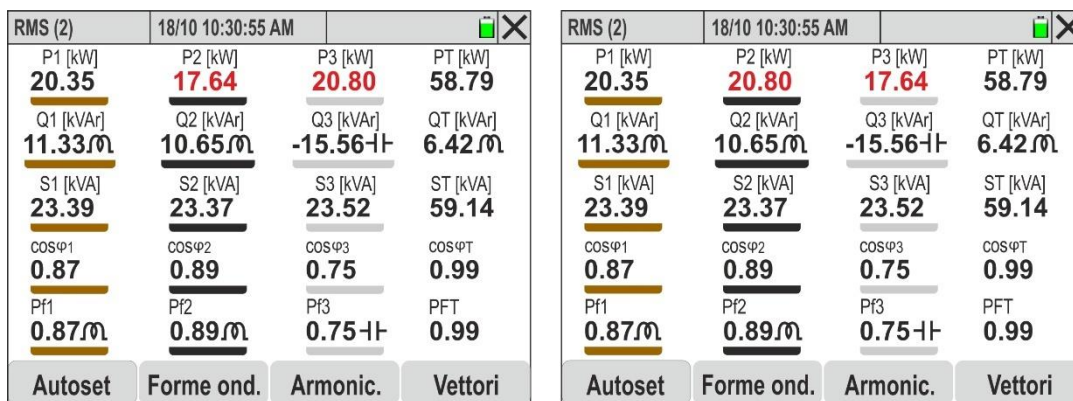

Fig. 73: Effect of the Autoset function in the Multimeter section (clamps reversed)

9. The Fig. 73 – left part shows the error condition described in point 8 where the active powers P2 and P3 are reversed (**the values shown in red are only to highlight the problem**). After the Autoset has been carried out, the new state appears as shown in Fig. 73 -right side, where the values of P2 and P3 have returned to the expected values **without any intervention by the operator**
10. The Fig. 74 - right part shows an example in which the Autoset function has detected and **automatically corrected** the presence of an incorrect phase difference between the voltages and currents on phases L2 and L3 due to an **incorrect connection of the current clamps (clamps 2 and 3 reversed on the respective conductors)**



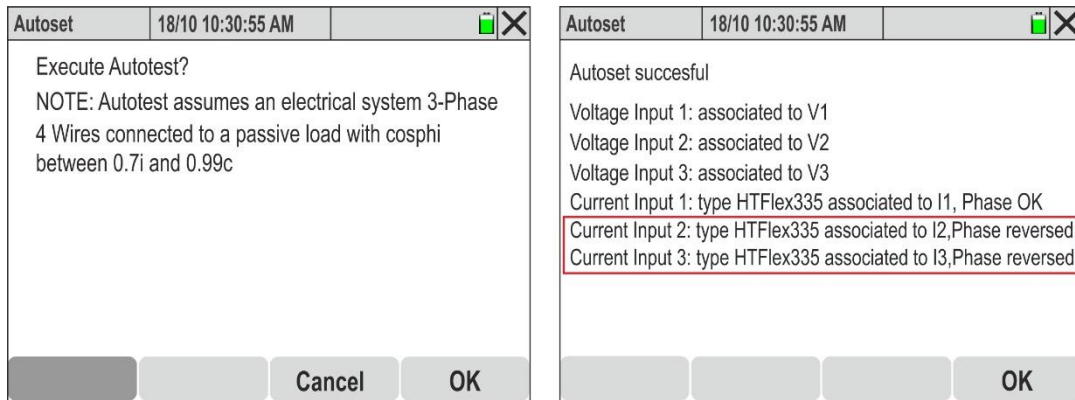

Fig. 74: Autotest execution with connection errors (clamps reversed)

11. The Fig. 75 – left part shows the error condition described in point 8 where the active powers P2 and P3 are **negative** (the values shown in red are only to highlight the problem). After the Autotest has been carried out, the new state appears as shown in Fig. 75-right part, where the values of P2 and P3 have returned to **positive** values without any intervention by the operator, who should have opened the clamps on phases L2 and L3 and rotated them by 180° to obtain the correct values

| RMS (2)   |            | 18/10 10:30:55 AM |           |  |  |
|-----------|------------|-------------------|-----------|--|--|
| P1 [kW]   | P2 [kW]    | P3 [kW]           | PT [kW]   |  |  |
| 20.35     | -20.80     | -17.64            | 58.79     |  |  |
| Q1 [kVAr] | Q2 [kVAr]  | Q3 [kVAr]         | QT [kVAr] |  |  |
| 11.33     | 10.65      | -15.56            | 6.42      |  |  |
| S1 [kVA]  | S2 [kVA]   | S3 [kVA]          | ST [kVA]  |  |  |
| 23.39     | 23.37      | 23.52             | 59.14     |  |  |
| COSφ1     | COSφ2      | COSφ3             | COSφT     |  |  |
| 0.87      | 0.89       | 0.75              | 0.99      |  |  |
| Pf1       | Pf2        | Pf3               | PfT       |  |  |
| 0.87      | 0.89       | 0.75              | 0.99      |  |  |
| Autotest  | Forme ond. | Armonic.          | Vettori   |  |  |

| RMS (2)   |            | 18/10 10:30:55 AM |           |  |  |
|-----------|------------|-------------------|-----------|--|--|
| P1 [kW]   | P2 [kW]    | P3 [kW]           | PT [kW]   |  |  |
| 20.35     | 20.80      | 17.64             | 58.79     |  |  |
| Q1 [kVAr] | Q2 [kVAr]  | Q3 [kVAr]         | QT [kVAr] |  |  |
| 11.33     | 10.65      | -15.56            | 6.42      |  |  |
| S1 [kVA]  | S2 [kVA]   | S3 [kVA]          | ST [kVA]  |  |  |
| 23.39     | 23.37      | 23.52             | 59.14     |  |  |
| COSφ1     | COSφ2      | COSφ3             | COSφT     |  |  |
| 0.87      | 0.89       | 0.75              | 0.99      |  |  |
| Pf1       | Pf2        | Pf3               | PfT       |  |  |
| 0.87      | 0.89       | 0.75              | 0.99      |  |  |
| Autotest  | Forme ond. | Armonic.          | Vettori   |  |  |

Fig. 75: Effect of the Autotest function in the Multimeter section (clamps reversed)



**CAUTION**

After having successfully performed the Autotest function, it is **recommended in any case** to always check that the signs of the active powers and the  $\cos\phi$  are consistent with the expected values before starting a recording.

### 6.3. STARTING AND STOPPING A RECORDING



**CAUTION**

- The instrument can only record when a memory card of the type described in § 9.2 is inserted in the slot (see Fig. 3- Part 2)
- Before starting a recording, it is **advisable to make a preliminary evaluation of the data measured in real time by the instrument**, in order to decide what to record or possibly use one of the predefined configurations (see § 5.3.2).
- It is **always advisable to start a recording by connecting the instrument to the supplied external power pack** so that no data are lost during the entire measurement process.

The instrument allows you to start recording from **any measurement screen** in the following ways:

- ✓ **MANUAL:** The recording starts from **the next minute (instant 00)** after the **GO/STOP** key is pressed.
- ✓ **AUTO:** If the **GO/STOP** key is pressed (**necessary**), the instrument will remain on hold until the set Date/Time is reached (see § 5.3.1) and then will start measuring.

The waiting "REC" and measuring "REC" states are indicated by the presence of the corresponding icons at the top of the display, as shown in the following figure:

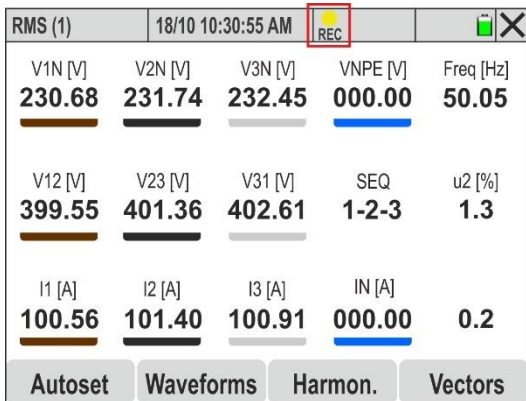

Fig. 76: Waiting to record

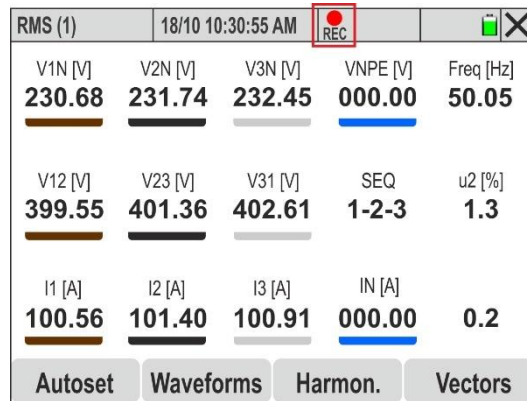

Fig. 77: Measuring

To stop measuring at any time, press the **GO/STOP** key again. The following screen will appear on the display:

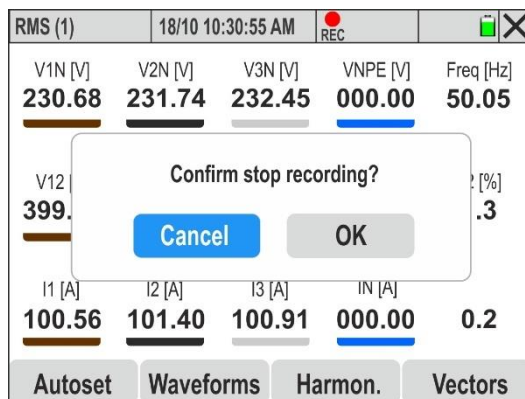

Fig. 78: Stopping a recording

Touch "OK" to confirm the operation or "Cancel" to exit without confirming

If the instrument detects the presence of **negative active powers**, the following screen appears on the display when the **GO/STOP** recording start key is pressed:

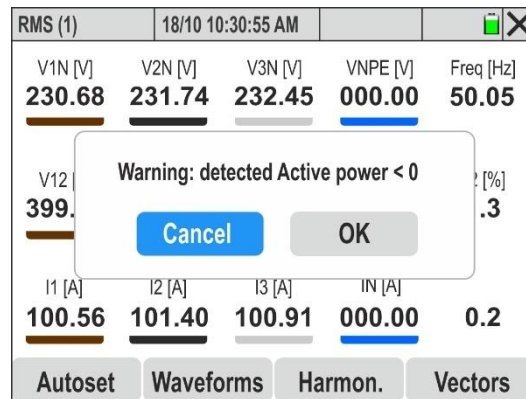

Fig. 79: Preliminary check on active powers

Pressing the "OK" key **allows the recording to start**, but a preliminary check of the current clamps connected to the installation and running the Autosest function is **recommended** (see § 6.2).

The instrument will accumulate data in the temporary memory for the set aggregation intervals (see § 5.3.1). After this time, the instrument processes the results stored in the temporary memory and stores the first set of values relating to the recording in the instrument's permanent memory. Therefore, assuming that you have set an integration period of 15min, **the duration of the recording must be at least 15 minutes (or in any case equal to the set integration period) to produce a series of recorded values that can then be transferred to the PC.**

### CAUTION



- When measuring, leave the instrument connected for **at least the duration of an integration period** in order to be able to save a measurement result. If you stop measuring before the end of an integration period, **the instrument will not save anything to the internal memory**
- Each recording is **automatically** stopped and stored by the instrument only when the **GO/STOP** key is pressed or the automatic stop date/time is reached
- **Only the "Real Time" section is available during a recording.** If other sections are selected, the instrument displays the message "Operation *not possible during recording*". End the recording by pressing the **GO/STOP** button
- The display of the "!" icon indicates the absence of the memory card or problems in reading it
- The display of the "MB" icon indicates that the memory is full

### 6.4. STORED DATA

The "Saved Data" section allows you to check the contents of the memory during and at the end of recording, as well as deleting stored measurements,

1. Touch the **"Saved Data"** icon. The following screen will be displayed

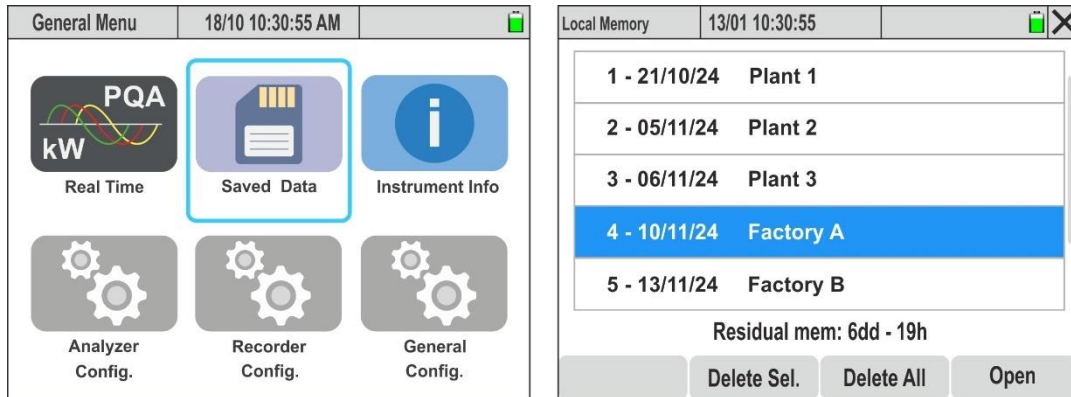

Fig. 80: Stored Data Section

2. Each line refers to the sequential storage of measurements stored with the instrument, and shows the date when it was performed and any comments (see § 5.3.1). Vertically scroll the sidebar or use the pen to view the entire list
3. The information on the **remaining memory (days/hours)**, displayed at the bottom of the screen, indicates the maximum duration of the next recording (or of the current recording, taking into account the recording parameters set)
4. Touch a row by highlighting it and select the **"Open"** key or press **Enter** to open the recording. The following screen will appear:

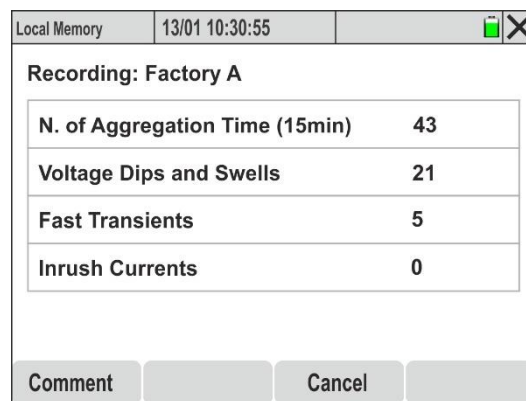

Fig. 81: General recording information

5. Summary information is displayed on the number of integration periods (or summation intervals) stored, the number of voltage anomalies (dips/peaks) stored, fast voltage transients and any inrush currents

### CAUTION



**The content of the recording can ONLY be viewed within the dedicated HTAgorà software after downloading it to the PC (see § 7)**

6. Touch the **"Delete Sel."** key to delete the selected recording
7. Touch the **"Delete All"** key to clear the entire memory
8. Touch the **"Comment"** key to change the comment of the open recording

### 6.5. INSTRUMENT INFO

This section provides the general parameters relating to the internal characteristics of the utility instrument in the event of contact with HT Customer Support.

1. Touch the "**Instrument Info**" icon. The following screen appears on the display:

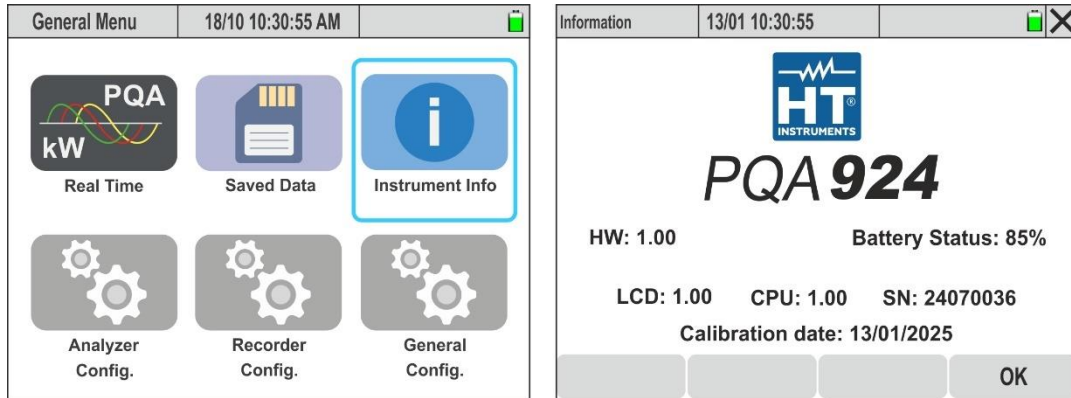

Fig. 82: Instrument info screen

2. The items present have the following meanings:

| Item             | Description                        |
|------------------|------------------------------------|
| Logo             | Manufacturer's name                |
| Model            | PQA924                             |
| SN               | Serial Number of the instrument    |
| HW               | Hardware version of the instrument |
| LCD, CPU         | Firmware version of the instrument |
| Calibration date | Date of last calibration           |
| Battery status   | Battery level percentage           |

3. Press "**OK**" to return to the general menu

## 7. CONNECTING THE INSTRUMENT TO A PC

The connection between PC and instrument for downloading recorded data can be managed in the following modes:

- Via **direct access** to the memory card connected to the PC with a relative reader (**recommended option in case of very large downloading recordings**)
- Via the USB-C port (see Fig. 3- Part 3) using the USB-C cable supplied
- Via WiFi connection to be enabled on the instrument (see § 5.1.7)
- Via Ethernet LAN network connection (see § 5.1.11)



**CAUTION**

In order to transfer data to a PC, it is necessary **in any case** to have previously installed the **HTAgorà** management SW, which can be downloaded from the [www.ht-instruments.com](http://www.ht-instruments.com) Website

### Connection via direct access to the memory card

1. Remove the memory card from the slot (see Fig. 3 – part 2)
2. Insert the memory card into a card reader and connect it to a USB port on the PC
3. Launch the **HTAgorà** software
4. Click on the “**Import**” button

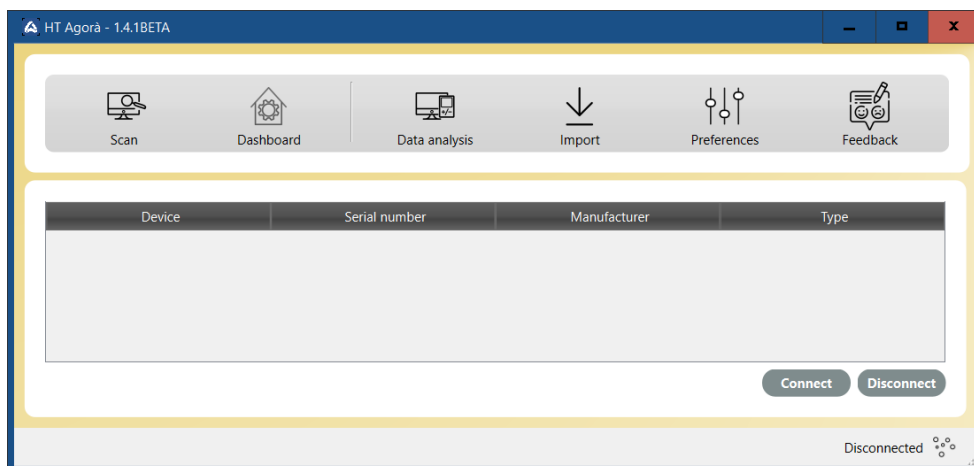
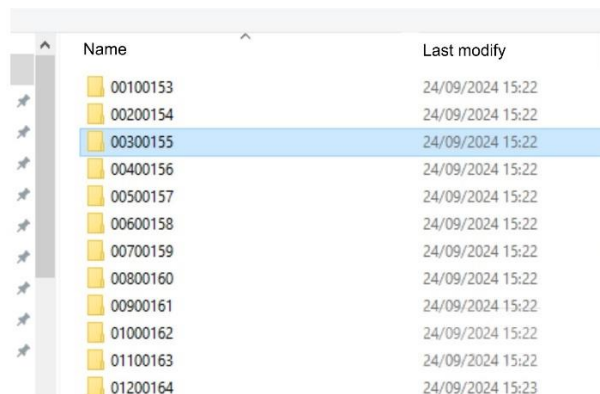

Fig. 83: Data import with HTAgorà software

5. From the removable disk “**13010 (disk name)**” select the folder containing the desired recording (for example “**00300155**” in the following figure)



6. Select the destination folder within the PC and confirm
7. The recording file, with **HQA** extension will be available in the selected folder
8. Open the HQA file of the recording with HTAgorà software

### Connection via USB-C cable

1. Switch on the instrument by pressing the **ON/OFF** key
2. **With the instrument on any screen**, connect it to a PC using the supplied USB-C **C2010** cable
3. Launch the HTAgorà software
4. Click on "**Scan**" to detect the instrument. The "PQA924" and type of connection "USB" are shown, as indicated in the Fig. 84

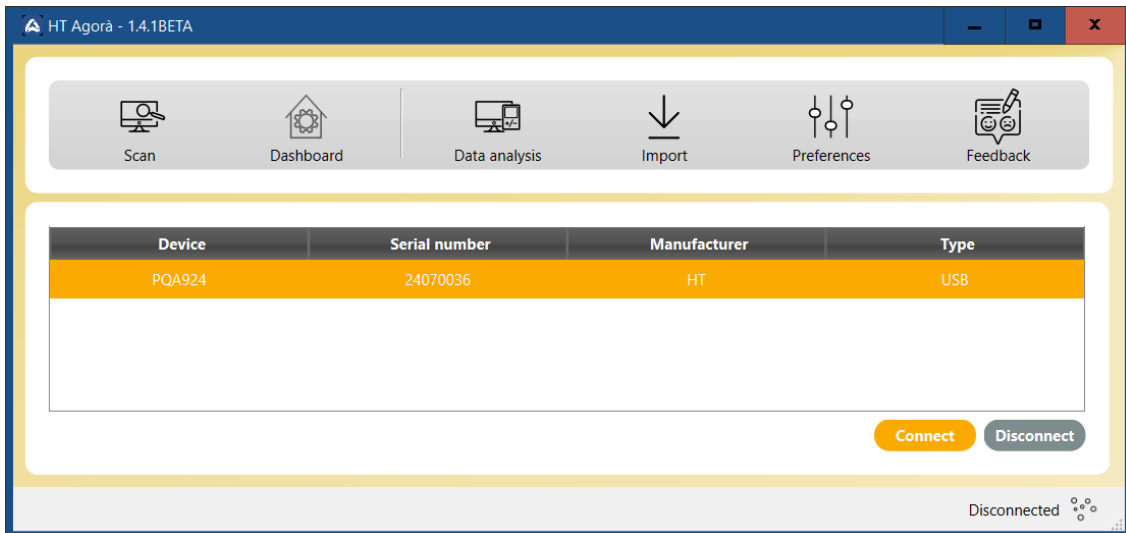

Fig. 84: Connecting the instrument via the HTAgorà software and USB connection

5. Click on "**Connect**" to connect the instrument and use the following internal interfaces of the software to manage the desired operations



**CAUTION**

The data cannot be transferred to the PC via USB-C cable during a recording. Press **GO/STOP** on the instrument to end the recording before performing the operation

### Connecting by WiFi

1. Switch on the instrument by pressing the **ON/OFF** key
2. Touch the "**General Config.**" icon in the general menu and select the "**ON**" option in the "**Hotspot WiFi**" function (see § 5.1.7)
3. Open the network access settings by clicking on the "" icon at the bottom right of the PC, select the item "**13010-xxxxxxx**", click on "**Connect**" and wait for the PC to confirm the recognition of the instrument
4. Launch the HTAgorà software
5. Click on "**Scan**" to detect the instrument. The row "PQA924" and type of connection "WiFi" are shown as indicated in the Fig. 85

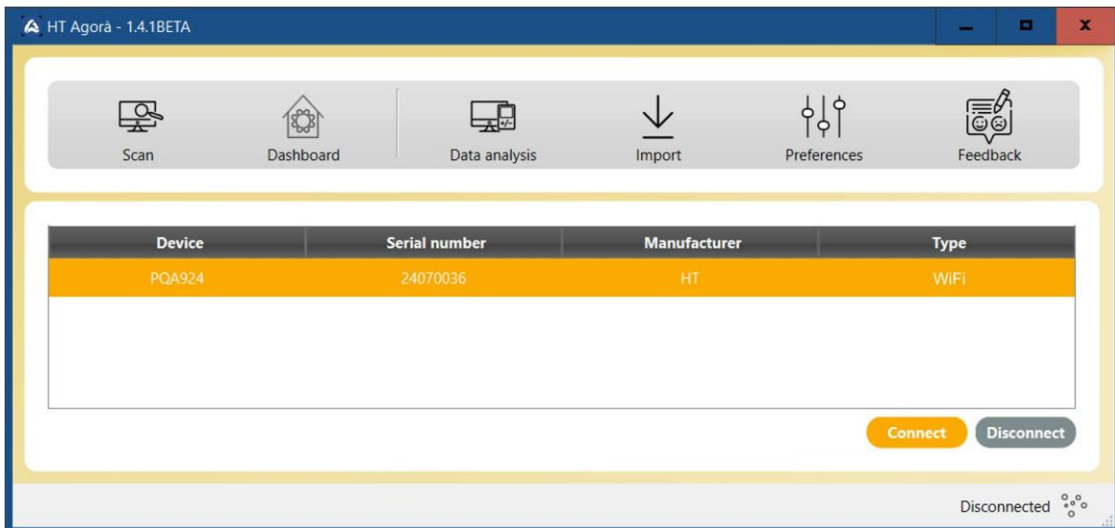

Fig. 85: Connecting the instrument via the HTAgorà software and WiFi connection

- Click on "**Connect**" to connect the instrument and use the following internal interfaces of the software to manage the desired operations



**CAUTION**

The data cannot be transferred to the PC during a recording. Press **GO/STOP** on the instrument to end the recording before performing the operation

**Connection via Ethernet network**

- Switch on the instrument by pressing the **ON/OFF** key
- Detect the IP address of the local Ethernet network to which the instrument is connected via the RJ45 input connector (see Fig. 2 – part 4), as described in § 5.1.11
- Launch the HTAgorà software
- Click on "**Scan**" to detect the instrument. The row "PQA924" and type of connection "NETWORK" are shown as indicated in the Fig. 86

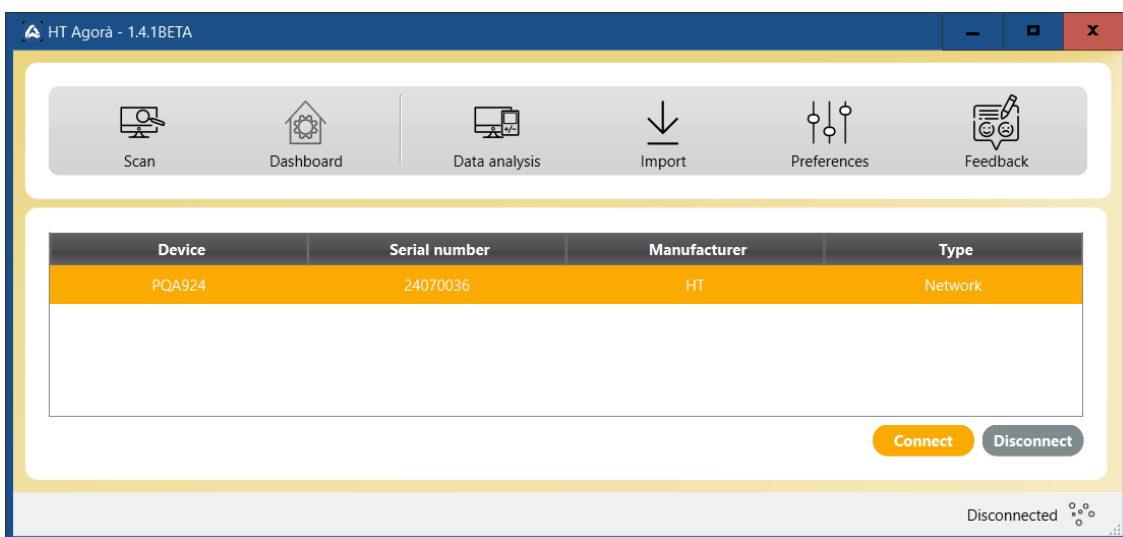

Fig. 86: Connecting the instrument via the HTAgorà software and Ethernet connection

- Click on "**Connect**" to connect the instrument and use the following internal interfaces of the software to manage the desired operations



## 8. MAINTENANCE

### 8.1. GENERAL INFORMATION

During use and storage, the recommendations in this manual must be followed to avoid possible damage or danger to the operator. Do not use the instrument in an environment with humidity or temperature outside the range specified in § 9.3. Do not expose to direct sunlight. Always switch off the instrument after using it. **If the instrument is to be left unused for a long period of time, remove the batteries to prevent leaking and damage to the internal circuits of the instrument.**

### 8.2. REPLACING OR RECHARGING INTERNAL BATTERIES

When the low battery symbol "" appears on the display, replace (if using alkaline batteries) or recharge (if using NiMH rechargeable batteries).



#### CAUTION

- This operation must be carried out by skilled technicians only. Before carrying out this operation, make sure that all the cables have been removed from the input terminals
- **Only use the supplied HT power supply unit** to recharge the batteries in order to avoid possible damage to the instrument

The following Table 2 indicates the possible states







| Icon on the display   | Status description  |
|---|---|
|  | Battery completely discharged. Recharge   |
|  | Low battery level. Charging is recommended  |
|  | Battery fully charged   |
|  | Average battery level   |
|  | Charging in progress  |
|  | Charging completed  |
|  | Problems with charging internal batteries. Use new batteries or contact HT customer support |

Table 2: Description of status of internal batteries

#### Replacing internal batteries

1. Switch off the instrument
2. Remove the cables from the input terminals
3. Unscrew the fixing screw of the battery compartment cover and remove it
4. Remove all batteries and replace with identical ones (see § 9.2), observing the polarity
5. Put back the battery compartment cover and fasten it by means of the appropriate screw
6. Do not dispose of the used batteries in the environment. For disposal, use appropriate containers

## Recharging internal batteries

**Always use the supplied external power pack** to fully recharge the batteries. The external power pack recharges the batteries both when the instrument **is on and off**. **Do not recharge alkaline batteries**. Proceed as follows:

1. Remove the cables from the input terminals
2. Switch on the instrument
3. Plug the external power supply unit into the instrument and connect it to the mains. The symbol "🔋" in the top right corner of the display indicates that the internal batteries are being charged
4. Recharge until the "🔋" icon is displayed
5. Disconnect the external power pack

### **8.3. INSTRUMENT CLEANING**

Use a dry and soft cloth to clean the instrument. Never use damp cloths, solvents, water, etc. paying particular attention to the TFT display.

## 9. TECHNICAL SPECIFICATIONS

### 9.1. TECHNICAL SPECIFICATIONS

Accuracy calculated as  $\pm[\% \text{reading} + \text{value}]$  at  $23^\circ\text{C} \pm 5^\circ\text{C}$ ,  $<70\% \text{RH}$ . Uncertainties for values outside the indicated recording ranges are not declared

#### AC TRMS (L-L / L-N) Voltage – Class S (IEC/EN61000-4-30)

| Range [V]     | U <sub>din</sub> [V] | Resolution [V] | Accuracy (V < 20% U <sub>din</sub> )    | Accuracy Class S (20% ÷ 120% U <sub>din</sub> ) |
|---------------|----------------------|----------------|---|---|
| 0.00 ÷ 999.99 | 100 ÷ 690            | 0.01           | $\pm(1.0\% \text{rdg} + 10 \text{dgt})$ | $\pm(0.5\% \text{U}_{\text{dinMIN}})$           |

U<sub>din</sub> = rated system voltage; Max crest factor: 1.5

The instrument can be connected to external VTs with transformation ratio included in the range: 1 ÷ 9999

#### Frequency – Class S (IEC/EN61000-4-30)

| Range [Hz]    | Resolution [Hz] | Accuracy             |
|---------------|-----------------|----------------------|
| 42.50 ÷ 57.50 | 0.01            | $\pm 0.05 \text{Hz}$ |
| 51.00 ÷ 69.00 |                 |                      |

Signal frequency detected between inputs L1-N or L1-L2

#### Voltage Anomalies (L-L / L-N) – Class S (IEC/EN61000-4-30)

| Range [V]     | Voltage Resolution | Anomalies Resolution | Anom. Dur. Resolution | Voltage Accuracy                      | Time Accuracy         |
|---------------|--------------------|----------------------|-----------------------|---------------------------------------|-----------------------|
| 1.00 ÷ 999.99 | 0.01V              | ½ cycle              | 1 cycle               | $\pm(1.0\% \text{U}_{\text{dinMIN}})$ | $\pm 2 \text{cycles}$ |

U<sub>din</sub> = rated system voltage; Anomalies hysteresis: 2%; Frequency range: 42.5Hz ÷ 69.0Hz; Voltage range U<sub>din</sub>: 100 ÷ 690V

Settable threshold:  $\pm 1\% \div \pm 30\%$ ; Voltage crest factor: 1.41

#### Fast Transients (L-PE Single/Three Phase) – Class S (IEC/EN61000-4-30)

| Range [V]    | Voltage Resolution [V] | Time Resolution [s] | Accuracy            |
|--------------|------------------------|---------------------|---------------------|
| -8000 ÷ 8000 | 10                     | 1μ                  | $\pm 3\% \text{FS}$ |

Max number of measurable events: 2000; Frequency range: 42.5Hz ÷ 69.0Hz; Minimum threshold: 200V/μs

Settable threshold: 50V ÷ 8kV;

#### Flicker - Single-Phase/Three Phase Systems - Class S (IEC/EN61000-4-30)

| Parameter                          | Range        | Resolution | Accuracy |
|------------------------------------|--------------|------------|----------|
| P <sub>st</sub><br>P <sub>lt</sub> | 0.400 ÷ 4000 | 0.001      | 10%      |

#### TRMS AC Current (Standard STD Transducer) - Class S (IEC/EN61000-4-30)

| Range [mV]  | Resolution [mV] | Accuracy                                |
|-------------|-----------------|---|
| 1.0 ÷ 99.9  | 0.1             | $\pm(2.0\% \text{rdg} + 0.5 \text{mV})$ |
| 100 ÷ 999.9 |                 | $\pm(2.0\% \text{rdg}) \text{ Class S}$ |

Signal values <1mV are reset; Frequency range: 42.5Hz ÷ 69.0Hz; Crest factor:  $\leq 3$

#### TRMS AC Current (FLEX Transducer – FS=300A) - Class S (IEC/EN61000-4-30)

| Range [mV]   | Resolution [μV] | Accuracy                                   |
|--------------|-----------------|--|
| 0,085 ÷ 2.55 | 8.5             | $\pm(2.0\% \text{rdg} + 42.5 \mu\text{V})$ |
| 2.55 ÷ 25.5  |                 | $\pm(2.0\% \text{rdg}) \text{ Class S}$    |

Signal values <85μV are reset; Frequency range: 42.5Hz ÷ 69.0Hz; Crest factor:  $\leq 3$

#### TRMS AC Current (FLEX Transducer – FS=3000A) - Class S (IEC/EN61000-4-30)

| Range [mV]  | Resolution [μV] | Accuracy                                  |
|-------------|-----------------|---|
| 0.85 ÷ 25.5 | 85              | $\pm(2.0\% \text{rdg} + 425 \mu\text{V})$ |
| 25.5 ÷ 255  |                 | $\pm(2.0\% \text{rdg}) \text{ Class S}$   |

Signal values <850μV are reset; Frequency range: 42.5Hz ÷ 69.0Hz; Crest factor:  $\leq 3$

#### TRMS AC Current (FLEX Transducer – FS=6000A) - Class S (IEC/EN61000-4-30)

| Range [mV] | Resolution [μV] | Accuracy                                  |
|------------|-----------------|---|
| 1.7 ÷ 51.0 | 170             | $\pm(2.0\% \text{rdg} + 850 \mu\text{V})$ |
| 51.0 ÷ 510 |                 | $\pm(2.0\% \text{rdg}) \text{ Class S}$   |

Signal values <1.7mV are reset; Frequency range: 42.5Hz ÷ 69.0Hz; Crest factor:  $\leq 3$

**TRMS AC Current (FLEX Transducer – FS=10000A) - Class S (IEC/EN61000-4-30)**

| Range [mV] | Resolution [ $\mu$ V] | Accuracy                  |
|------------|-----------------------|---------------------------|
| 1.7 ÷ 85.0 | 283                   | $\pm(2.0\%rdg+1400\mu V)$ |
| 85.0 ÷ 850 |                       | $\pm(2.0\%rdg)$           |

Signal values <1.7mV are reset; Frequency range: 42.5Hz ÷ 69.0Hz; Crest factor:  $\leq 1.8$

**Inrush currents - (Standard STD Transducer)**

| Range [mV]  | Voltage Resolution [mV] | Time Resolution         | Voltage Accuracy    | Time Accuracy           |
|-------------|-------------------------|-------------------------|---------------------|-------------------------|
| 1.0 ÷ 999.9 | 0.1                     | $\pm \frac{1}{2}$ cycle | $\pm(2\%rdg+0.5mV)$ | $\pm \frac{1}{2}$ cycle |

Signal values <1mV are reset; Frequency range: 42.5Hz ÷ 69.0Hz; Crest factor:  $\leq 3$

**Inrush currents - (FLEX Transducer FS=300A)**

| Range [mV]   | Voltage Resolution [ $\mu$ V] | Time Resolution         | Voltage Accuracy        | Time Accuracy           |
|--------------|-------------------------------|-------------------------|-------------------------|-------------------------|
| 0,085 ÷ 25.5 | 8.5                           | $\pm \frac{1}{2}$ cycle | $\pm(2\%rdg+42.5\mu V)$ | $\pm \frac{1}{2}$ cycle |

Signal values <85 $\mu$ V are reset; Frequency range: 42.5Hz ÷ 69.0Hz; Crest factor:  $\leq 3$

**Inrush currents - (FLEX Transducer FS=3000A)**

| Range [mV] | Voltage Resolution [ $\mu$ V] | Time Resolution         | Voltage Accuracy       | Time Accuracy           |
|------------|-------------------------------|-------------------------|------------------------|-------------------------|
| 0.85 ÷ 255 | 85                            | $\pm \frac{1}{2}$ cycle | $\pm(2\%rdg+425\mu V)$ | $\pm \frac{1}{2}$ cycle |

Signal values <850 $\mu$ V are reset; Frequency range: 42.5Hz ÷ 69.0Hz; Crest factor:  $\leq 3$

**Inrush currents - (FLEX Transducer FS=6000A)**

| Range [mV] | Voltage Resolution [ $\mu$ V] | Time Resolution         | Voltage Accuracy       | Time Accuracy           |
|------------|-------------------------------|-------------------------|------------------------|-------------------------|
| 1.7 ÷ 510  | 170                           | $\pm \frac{1}{2}$ cycle | $\pm(2\%rdg+425\mu V)$ | $\pm \frac{1}{2}$ cycle |

Signal values <1.7mV are reset; Frequency range: 42.5Hz ÷ 69.0Hz; Crest factor:  $\leq 3$

**Inrush currents - (FLEX Transducer FS=10000A)**

| Range [mV] | Voltage Resolution [ $\mu$ V] | Time Resolution         | Voltage Accuracy       | Time Accuracy           |
|------------|-------------------------------|-------------------------|------------------------|-------------------------|
| 1.7 ÷ 850  | 283                           | $\pm \frac{1}{2}$ cycle | $\pm(2\%rdg+710\mu V)$ | $\pm \frac{1}{2}$ cycle |

Signal values <1.7mV are reset; Frequency range: 42.5Hz ÷ 69.0Hz; Crest factor:  $\leq 1.8$

**Amplitude Voltage Harmonics/Interharmonics - Class S (IEC/EN61000-4-30)**

| Order    | Condition                                | U <sub>din</sub> [V] | Resolution [V] | Accuracy            |
|----------|--|----------------------|----------------|---------------------|
| DC ÷ 63° | U <sub>h</sub> $\geq$ 3%U <sub>din</sub> | 100 ÷ 690            | 0.01           | $\pm 10\%rdg$       |
|          | U <sub>h</sub> < 3%U <sub>din</sub>      |                      |                | $\pm 0.30\%U_{din}$ |

U<sub>din</sub> = rated system voltage ; Fundamental frequency range: 42.5Hz ÷ 69.0Hz

**Phase Voltage Harmonics - Class S (IEC/EN61000-4-30)**

| Order    | Condition                                | U <sub>din</sub> [V] | Resolution [°] | Accuracy                                       |
|----------|--|----------------------|----------------|--|
| DC ÷ 63° | U <sub>h</sub> $\geq$ 3%U <sub>din</sub> | 100 ÷ 690            | 0.01           | $\pm(\text{order } h \times 1^\circ)$          |
|          | U <sub>h</sub> < 3%U <sub>din</sub>      |                      |                | $\pm(2 \times \text{order } h \times 1^\circ)$ |

U<sub>din</sub> = rated system voltage ; Fundamental frequency range: 42.5Hz ÷ 69.0Hz

**Amplitude Current Harmonics/Interharmonics - Class S (IEC/EN61000-4-30)**

| Order    | Condition                   | Resolution [A] | Accuracy       |
|----------|-----------------------------|----------------|----------------|
| DC ÷ 63° | I <sub>h</sub> $\geq$ 10%FS | 0.1            | $\pm 10\%rdg$  |
|          | I <sub>h</sub> < 10%FS      |                | $\pm 0.30\%FS$ |

FS = Full scale of the clamp used; Fundamental frequency range: 42.5Hz ÷ 69.0Hz

**Phase Current Harmonics - Class S (IEC/EN61000-4-30)**

| Order    | Condition                   | Resolution [°] | Accuracy                                       |
|----------|-----------------------------|----------------|--|
| DC ÷ 63° | I <sub>h</sub> $\geq$ 10%FS | 0.01           | $\pm(\text{order } h \times 1^\circ)$          |
|          | I <sub>h</sub> < 10%FS      |                | $\pm(2 \times \text{order } h \times 1^\circ)$ |

FS = Full scale of the clamp used; Fundamental frequency range: 42.5Hz ÷ 69.0Hz

**Power Harmonics - Class S (IEC/EN61000-4-30)**

| Voltage condition                   | Current condition      | U <sub>din</sub> [V] | Resolution [W] | Accuracy                                |
|-------------------------------------|------------------------|----------------------|----------------|---|
| U <sub>h</sub> ≥ 3%U <sub>din</sub> | I <sub>h</sub> ≥ 10%FS | 100 ÷ 690            | 0.1            | ±(20%rdg+10dgt)                         |
|                                     | I <sub>h</sub> < 10%FS |                      |                | ±(0.30%FS+10%rdg+10dgt)                 |
| U <sub>h</sub> < 3%U <sub>din</sub> | I <sub>h</sub> ≥ 10%FS |                      |                | ±(0.30%U <sub>din</sub> +10%rdg+10dgt)  |
|                                     | I <sub>h</sub> < 10%FS |                      |                | ±(0.30%U <sub>din</sub> +0.30%FS+10dgt) |

FS = Full scale of the clamp used; U<sub>din</sub> = rated system voltage ; Fundamental frequency range: 42.5Hz ÷ 69.0Hz

**Active/Apparent Power/Energy (V: [80%..120%U<sub>din</sub>], I:FS[1..3000A], cosφ = 1) – STD clamp**

| Current range [mV] | Range [W], [Wh], [VA]     | Resolution [W], [Wh], [VA] | Accuracy   |
|--------------------|---------------------------|----------------------------|------------|
| 10 ÷ 50            | 0.000 x FS ÷ 9.999 x FS   | 0.001 x FS                 | ±(2.0%rdg) |
|                    | 10.00 x FS ÷ 99.99 x FS   | 0.01 x FS                  |            |
|                    | 100.0 x FS ÷ 999.9 x FS   | 0.1 x FS                   |            |
| 50 ÷ 1000          | 1.000k x FS ÷ 9.999k x FS | 0.001k x FS                | ±(1.5%rdg) |
|                    | 10.00k x FS ÷ 99.99k x FS | 0.01k x FS                 |            |
|                    | 100.0k x FS ÷ 999.9k x FS | 0.1k x FS                  |            |
|                    | 1000k x FS ÷ 9999k x FS   | 1k x FS                    |            |

FS = full scale of clamp; Fundamental frequency: 42.5 ÷ 69Hz, Sinusoidal voltages and currents

**Active/Apparent Power/Energy (V: [80%..120%U<sub>din</sub>], I: FS = 300A, cosφ = 1) – FLEX Clamp**

| Current range [mV] | Range [W], [Wh], [VA] | Resolution [W], [Wh], [VA] | Accuracy   |
|--------------------|-----------------------|----------------------------|------------|
| 0,255 ÷ 1275       | 0.0 ÷ 999.5           | 0.5                        | ±(2.0%rdg) |
|                    | 1.000k ÷ 9.999k       | 0.005k                     |            |
|                    | 10.00k ÷ 99.99k       | 0.05k                      |            |
| 1,275 ÷ 25.5       | 100.0k ÷ 999.9k       | 0.5k                       | ±(1.5%rdg) |
|                    | 1000k ÷ 9999k         | 5k                         |            |

Fundamental frequency: 42.5 ÷ 69Hz, Sinusoidal voltages and currents

**Active/Apparent Power/Energy (V:[80%..120%U<sub>din</sub>], I:FS=3000A,cosφ = 1) – FLEX Clamp**

| Current range [mV] | Range [W], [Wh], [VA] | Resolution [W], [Wh], [VA] | Accuracy   |
|--------------------|-----------------------|----------------------------|------------|
| 2.55 ÷ 12.75       | 0 ÷ 9999              | 5                          | ±(2.0%rdg) |
|                    | 10.00k ÷ 99.99k       | 0.05k                      |            |
|                    | 100.0k ÷ 999.9k       | 0.5k                       |            |
| 12.75 ÷ 255        | 1000k ÷ 9999k         | 5k                         | ±(1.5%rdg) |
|                    | 1.000M ÷ 9.999M       | 0.005M                     |            |

Fundamental frequency: 42.5 ÷ 69Hz, Sinusoidal voltages and currents

**Active/Apparent Power/Energy (V: [80%..120%U<sub>din</sub>], I: FS = 6000A, cosφ = 1) – FLEX Clamp**

| Current range [mV] | Range [W], [Wh], [VA] | Resolution [W], [Wh], [VA] | Accuracy   |
|--------------------|-----------------------|----------------------------|------------|
| 5.1 ÷ 25.5         | 0 ÷ 9999              | 5                          | ±(2.0%rdg) |
|                    | 10.00k ÷ 99.99k       | 0.05k                      |            |
|                    | 100.0k ÷ 999.9k       | 0.5k                       |            |
| 25.5 ÷ 510         | 1000k ÷ 9999k         | 5k                         | ±(1.5%rdg) |
|                    | 1.000M ÷ 9.999M       | 0.005M                     |            |

Fundamental frequency: 42.5 ÷ 69Hz, Sinusoidal voltages and currents

**Active/Apparent Power/Energy (V:[80%..120%U<sub>din</sub>], I:FS=10000A,cosφ = 1) – FLEX Clamp**

| Current range [mV] | Range [W], [Wh], [VA] | Resolution [W], [Wh], [VA] | Accuracy   |
|--------------------|-----------------------|----------------------------|------------|
| 5.1 ÷ 25.5         | 0 ÷ 9999              | 5                          | ±(2.0%rdg) |
|                    | 10.00k ÷ 99.99k       | 0.05k                      |            |
|                    | 100.0k ÷ 999.9k       | 0.5k                       |            |
| 25.5 ÷ 850         | 1000k ÷ 9999k         | 5k                         | ±(1.5%rdg) |
|                    | 1.000M ÷ 9.999M       | 0.005M                     |            |

Fundamental frequency: 42.5 ÷ 69Hz, Sinusoidal voltages and currents

**AC Reactive Power/Energy (V: [80%..120%U<sub>din</sub>], I: FS [1..3000A], cosφ = 0.5) – STD Clamp**

| Current range [mV] | Range [VAr] [VArh]   | Resolution [VAr] [VArh]                           | Accuracy   |
|--------------------|--|---|------------|
| 20 ÷ 100           | 0.000 x FS ÷ 9.999 x FS<br>10.00 x FS ÷ 99.99 x FS<br>100.0 x FS ÷ 999.9 x FS                                  | 0.001 x FS<br>0.01 x FS<br>0.1 x FS               | ±(2.0%rdg) |
| 100 ÷ 1000         | 1.000k x FS ÷ 9.999k x FS<br>10.00k x FS ÷ 99.99k x FS<br>100.0k x FS ÷ 999.9k x FS<br>1000k x FS ÷ 9999k x FS | 0.001k x FS<br>0.01k x FS<br>0.1k x FS<br>1k x FS | ±(1.5%rdg) |

FS = full scale of clamp; Fundamental frequency: 42.5 ÷ 69Hz, Sinusoidal voltages and currents

**AC Reactive Power/Energy (V: [80%..120%U<sub>din</sub>], I: FS = 300A, cosφ = 0.5) – FLEX Clamp**

| Current range [mV] | Range [VAr] [VArh]                                | Resolution [VAr] [VArh] | Accuracy   |
|--------------------|---|-------------------------|------------|
| 0,510 ÷ 2.55       | 0.0 ÷ 999.5<br>1.000k ÷ 9.999k<br>10.00k ÷ 99.99k | 0.5<br>0.005k<br>0.05k  | ±(2.0%rdg) |
| 2.55 ÷ 25.5        | 100.0k ÷ 999.9k<br>1000k ÷ 9999k                  | 0.5k<br>5k              | ±(1.5%rdg) |

Fundamental frequency: 42.5 ÷ 69Hz, Sinusoidal voltages and currents

**AC Reactive Power/Energy (V: [80%..120%U<sub>din</sub>], I: FS = 3000A, cosφ = 0.5) – FLEX Clamp**

| Current range [mV] | Range [VAr] [VArh]                             | Resolution [VAr] [VArh] | Accuracy   |
|--------------------|--|-------------------------|------------|
| 5.10 ÷ 25.5        | 0 ÷ 9999<br>10.00k ÷ 99.99k<br>100.0k ÷ 999.9k | 5<br>0.05k<br>0.5k      | ±(2.0%rdg) |
| 25.5 ÷ 255         | 1000k ÷ 9999k<br>1.000M ÷ 9.999M               | 5k<br>0.005M            | ±(1.5%rdg) |

Fundamental frequency: 42.5 ÷ 69Hz, Sinusoidal voltages and currents

**AC Reactive Power/Energy (V: [80%..120%U<sub>din</sub>], I: FS = 6000A, cosφ = 0.5) – FLEX Clamp**

| Current range [mV] | Range [VAr] [VArh]                             | Resolution [VAr] [VArh] | Accuracy   |
|--------------------|--|-------------------------|------------|
| 10.2 ÷ 51.0        | 0 ÷ 9999<br>10.00k ÷ 99.99k<br>100.0k ÷ 999.9k | 5<br>0.05k<br>0.5k      | ±(2.0%rdg) |
| 51.0 ÷ 510         | 1000k ÷ 9999k<br>1.000M ÷ 9.999M               | 5k<br>0.005M            | ±(1.5%rdg) |

Fundamental frequency: 42.5 ÷ 69Hz, Sinusoidal voltages and currents

**AC Reactive Power/Energy (V: [80%..120%U<sub>din</sub>], I: FS = 10000A, cosφ = 0.5) – FLEX Clamp**

| Current range [mV] | Range [VAr] [VArh]                             | Resolution [VAr] [VArh] | Accuracy   |
|--------------------|--|-------------------------|------------|
| 10.2 ÷ 51.0        | 0 ÷ 9999<br>10.00k ÷ 99.99k<br>100.0k ÷ 999.9k | 5<br>0.05k<br>0.5k      | ±(2.0%rdg) |
| 51.0 ÷ 850         | 1000k ÷ 9999k<br>1.000M ÷ 9.999M               | 5k<br>0.005M            | ±(1.5%rdg) |

Fundamental frequency: 42.5 ÷ 69Hz, Sinusoidal voltages and currents

**Power Factor and cosφ – (V: [80%..120%U<sub>din</sub>], I: >10% FS clamp)**

| Range       | Resolution | Accuracy |
|-------------|------------|----------|
| 0.20 ÷ 1.00 | 0.01       | ±0.04    |

Fundamental frequency: 42.5 ÷ 69Hz, Sinusoidal voltages and currents

## 9.2. GENERAL CHARACTERISTICS

### Instrument functions

|                                  |  |
|----------------------------------|--|
| Periodic analysis (TRMs values): | Voltages (5 channels), Currents (4 channels), Active, Reactive, Apparent Powers, Power factors and $\cos\phi$ (4 quadrants), Active and Reactive Energies (4 quadrants), Voltage dissymmetry, Flicker, Peak values |
| Harmonic analysis:               | Voltage Histograms, Currents (amplitude/phase), Powers (amplitude), Interharmonics, K Factor up to the 63rd order, THD%, TH1%, Incoming and outgoing harmonics   |
| Signal waveforms:                | Voltages, Currents   |
| Vectorial diagrams:              | Voltages, Currents   |
| Voltage anomalies:               | Dips, peaks, interruptions (max 2000 events)   |
| Fast voltage transients:         | up to 8kV (max 2000 events)  |
| Inrush currents: max             | 2000 events  |

### Measurements

|                                  |  |
|----------------------------------|--|
| Number of measurable parameters: | 3180 + voltage/current events  |
| Integration Period (IP):         | 0.2s, 3s, 10s, 15s, 18s, 30s, 1min, 5min, 10min, 15min, 30min, 60min, 120m             |
| Frequency integration period:    | 1s ÷ 30s   |
| Harmonic integration period:     | 0.2s, 3s, 6s, 10s, 12s, 15s, 18s, 30s, 1min, 5min, 10min, 15 min, 30min, 60min, 120min |
| Maximum recording size:          | 512MB (all parameters), max 99 recordings  |
| Measuring autonomy:              | approx. 408 days (IP= 10min), app. 3 hours (IP= 0.2s)                                  |

### Display

|                        |   |
|------------------------|---|
| Characteristics:       | 3.5" (320x240pxl) graphic display, TFT, colours, backlit resistive touch screen |
| Brightness adjustment: | programmable  |

### Memory and PC interfaces

|                          |  |
|--------------------------|--|
| Memory for data storage: | External memory card ( <b>Min. writing speed 10MB/s, formatted FAT32</b> ) |
| Interface with PC:       | USB-C, WiFi, Ethernet (LAN RJ45)   |

### Power supply

|                        |  |
|------------------------|--|
| Internal power supply: | 6x 1.5V alkaline batteries - type AA LR06 or 6x1.2V rechargeable NiMH batteries - type AA LR06 |
| Charging time:         | approx. 6 hours  |
| Charger power pack:    | 100-415VAC/15VDC, 8W, 50/60Hz  |
| Auto Power Off:        | after 5 minutes of non-use (without power pack)  |

### Mechanical characteristics

|                            |                                  |
|----------------------------|----------------------------------|
| Dimensions (L x P x H):    | 235 x 165 x 75mm ; (9 x 6 x 3in) |
| Weight (battery included): | 1.2 kg ; (2.5lv)                 |
| Mechanical protection:     | IP40                             |

### Reference guidelines

|                                       |   |
|---------------------------------------|---|
| Instrument safety:                    | IEC/EN61010-1, IEC/EN61010-2-030, IEC/EN61010-2-033             |
| EMC:                                  | IEC/EN61326-1   |
| Technical literature:                 | IEC/EN61187   |
| Safety of measuring accessories:      | IEC/EN61010-031, IEC/EN61010-2-032                              |
| Insulation:                           | double insulation   |
| Pollution grade:                      | 2   |
| Measurement category:                 | CAT IV 600V, CAT III 1000V to Earth<br>max 1000V between inputs |
| Network quality                       | IEC/EN61000-4-30 – Class S                                      |
| Network voltage quality:              | EN50160   |
| Flicker:                              | IEC/EN61000-4-15  |
| Harmonics, Interharmonics, Unbalance: | IEC/EN61000-4-7   |

### 9.3. ENVIRONMENTAL CONDITIONS FOR USE

|                        |   |
|------------------------|---|
| Reference temperature: | 23°C ± 5°C ; (73°F ± 41°F)  |
| Working temperature:   | -10°C ÷ 50°C ; (14°F ÷ 122°F)   |
| Relative humidity:     | 10°C ÷ 30°C → <95%RH (non-condensing)<br>30°C ÷ 40°C → <75%RH (non-condensing)<br>40°C ÷ 50°C → <45%RH (non-condensing) |
| Storage temperature:   | -20°C ÷ 60°C ; (-4°F ÷ 140°F)   |
| Storage humidity:      | <80%RH  |
| Max. altitude:         | 2000m ; (6562ft)  |

**This instrument complies with the requirements of the Low Voltage Directive 2014/35/EU (LVD) and the EMC Directive 2014/30/EU and RED Directive 2014/53/EU  
This instrument complies with the requirements of European Directive 2011/65/EU (RoHS) and European Directive 2012/19/EU (WEEE)**

### 9.4. ACCESSORIES

See the attached packing list



## 10. APPENDIX – THEORETICAL OUTLINES

### 10.1. VOLTAGE ANOMALIES

The instrument defines a voltage anomaly as an event in which the TRMS value, calculated on a cycle updated every half cycle, of one or more voltages exceeds the set upper or lower threshold. These limits remain unchanged throughout the recording. In general, voltage anomalies (dips, swells or interruptions) are considered closed when all the voltages concerned are within the programmed thresholds with the addition of a percentage **hysteresis** value as indicated in the following Fig. 87

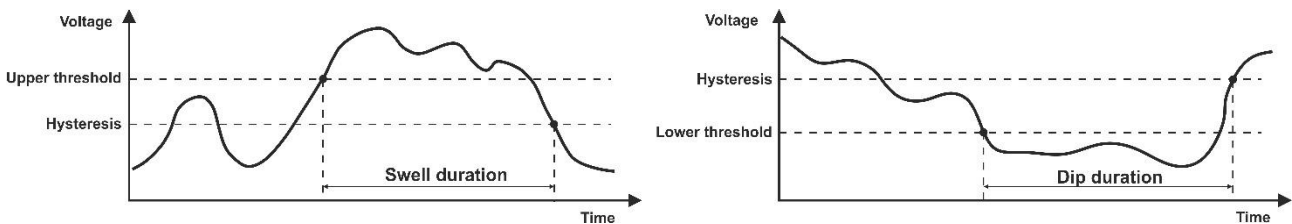

Fig. 87: References in the detection of voltage anomalies

The value of the Reference Voltage must be set as:

Single-phase and Three-phase four-wire systems **Phase-Neutral** → rated voltage  
 Three-phase three-wire systems **Phase-Phase** → rated voltage.

**Example1: 3-Phase 3 Wires system**

$V_{ref} = 400V$ ,  $LIM+= 10\%$ ,  $Lim-=10\%$   
 $Lim Up= 400 \times (1+10/100) = 440V$   
 $Lim Inf = 400 \times (1-10/100) = 360V$

**Example2: 3-Phase 4 Wires system**

$V_{ref} = 230V$ ,  $LIM+= 10\%$ ,  $Lim-=10\%$   
 $Lim Up= 230 \times (1+10/100) = 253V$   
 $Lim Inf = 230 \times (1-10/100) = 207V$



**CAUTION**

- The display of measured data on voltage anomalies is **only possible with the HTAgorà software**
- The detection and storage of voltage anomalies, as independent events, **DOES NOT follow** the integration periods set on the instrument

- The number corresponding to the phase in which the anomaly occurred.
- The "direction" of the anomaly: "Up", "Down" or "Break" identify voltage peaks, dips or interruptions respectively
- The start date and time of the event
- The duration of the event
- The minimum (or maximum) value of the voltage during the phenomenon
- The graph of the 10 cycles (@50Hz) / 12 cycles (@60Hz) in which an event began
- The graph of the 10 cycles (@50Hz) / 12 cycles (@60Hz) in which the event ended

## 10.2. VOLTAGE AND CURRENT HARMONICS

### 10.2.1. Theory

Any **non-sinusoidal** periodic wave can be represented by a sum of sine waves, each with an integral multiple of the **fundamental** frequency (@50Hz or @60Hz) according to the ratio:

$$V(t) = V_0 + \sum_{k=1}^{\infty} V_k \sin(\omega_k t + \varphi_k) \quad (1)$$

where:

$V_0$  = Mean signal value  $V(t)$

$V_k$  = Amplitude of the  $k$ -th harmonic of  $V(t)$

$\omega_k = 2\pi f_k = k$ -th harmonic pulsation

$f_k$  = frequency of the  $k$ -th harmonic

$\varphi_k$  = phase angle of the  $k$ -th harmonic

In the case of network voltage, the fundamental has a frequency of 50Hz, the second harmonic has a frequency of 100Hz, the third harmonic has a frequency of 150Hz and so on. Harmonic distortion is a constant problem and should not be confused with short-lived phenomena such as spikes, drops or fluctuations. The phase angle of the harmonic identifies the zero point with respect to the origin and can significantly affect the maximum amplitude of the resulting harmonic signal.

It can be seen how in (1) the index of the sum goes from **1 to  $\infty$** . What actually happens is that each signal does not have an unlimited number of harmonics: **there is always an order number beyond which the value of the harmonics is negligible**. The following Fig. 88 is an example of the superimposition of a 3rd order harmonic on a sinusoidal fundamental of a signal. The fact that the phase of the harmonic is in phase opposition produces a resulting signal that is significantly distorted and of greater amplitude than the fundamental, which could cause significant problems in the management of the protections.

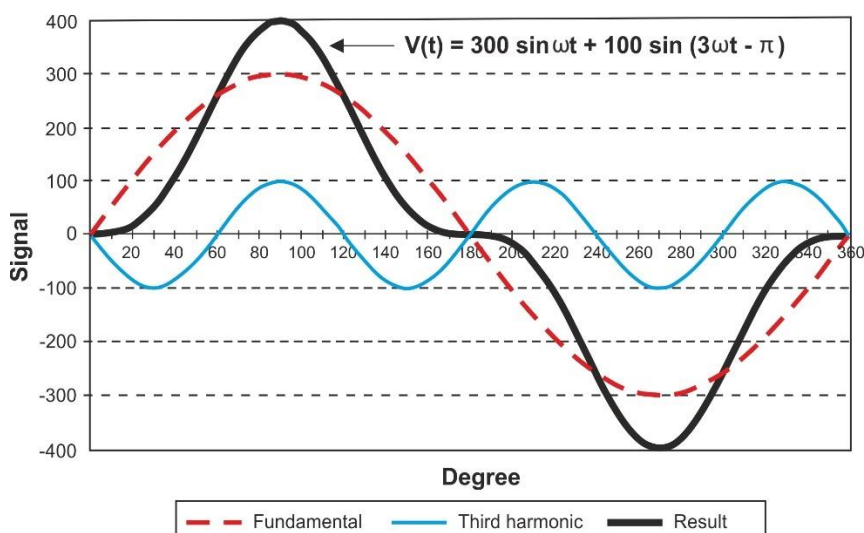

Fig. 88: Harmonic analysis – Effect of the sum of 2 multiple frequencies

The EN50160 and IEC/EN61000-4-30 Class S regulations suggest truncating the sum in expression (1) to the **40th order**. A fundamental index for detecting the presence of harmonics is the Total Harmonic Distortion (**THD%** percentage value) parameter, defined as:

$$THDV\% = \frac{\sqrt{\sum_{h=2}^{40} V_h^2}}{V_1} \times 100$$

This index takes into account the presence of all harmonics: the more distorted the voltage or current waveform, the higher the index.

**10.2.2. Limit values for voltage harmonics**

The EN50160 standard sets the limits on the **maximum amplitudes of harmonic voltages** that the supplier can introduce into the network. Under normal operating conditions, over a period of one week, 95% of the rms values of each harmonic voltage, averaged over 10 minutes, must be less than or equal to the values shown in (\*) Values indicated in percentage referred to the fundamental U1

NOTE: no value is indicated for harmonics of order greater than 25 as they have very small amplitudes and are not predictable due to resonance phenomena

Table 3. The total harmonic distortion (THD) of the supply voltage (including all harmonics up to the 40th order) **must be less than or equal to 8%**.

| ODD HARMONICS (*)  |                           |                |                           | EVEN HARMONICS (*) |                           |
|--------------------|---------------------------|----------------|---------------------------|--------------------|---------------------------|
| Not multiples of 3 |                           | Multiples of 3 |                           | Order h            | Max relative amplitude Uh |
| Order h            | Max relative amplitude Uh | Order h        | Max relative amplitude Uh |                    |                           |
| 5                  | 6.0%                      | 3              | 5.0%                      | 2                  | 2.0%                      |
| 7                  | 5.0%                      | 9              | 1.5%                      | 4                  | 1.0%                      |
| 11                 | 3.5%                      | 15             | 1.0%                      | 6..24              | 0.5%                      |
| 13                 | 3.0%                      | 21             | 0.75%                     |                    |                           |
| 17                 | 2.0%                      |                |                           |                    |                           |
| 19                 | 1.5%                      |                |                           |                    |                           |
| 23                 | 1.5%                      |                |                           |                    |                           |
| 25                 | 1.5%                      |                |                           |                    |                           |

(\*) Values indicated in percentage referred to the fundamental U1

NOTE: no value is indicated for harmonics of order greater than 25 as they have very small amplitudes and are not predictable due to resonance phenomena

Table 3: Harmonic voltage reference values according to EN50160

These limits, which theoretically only apply to electricity suppliers, provide a set of reference values within which the harmonics fed into the grid by users are also contained.

### 10.2.3. Causes of the presence of harmonics

Any user who modifies the sine wave, or uses only part of it, will cause distortion and therefore introduce a harmonic content.

**All current signals are somehow virtually distorted.** The most common harmonic distortion is caused by **NON-LINEAR loads** such as appliances, PCs or motor speed regulators. Harmonic distortion generates significant currents at frequencies that are integer multiples of the grid frequency. Harmonic currents have a considerable effect on the neutral conductors of electrical systems.

The mains voltage used in most countries is three-phase 50/60Hz, supplied by a transformer with a delta primary and a star secondary. The secondary generally produces 230VAC between phase and neutral and 400VAC between phase and phase.

Balancing loads for each phase has always been a puzzle for electrical system designers. Until a few decades ago, in a well-balanced system, the vector sum of the currents in the neutral was zero, or at least quite small (given the difficulty of achieving perfect balance). The connected equipment were incandescent lamps, small motors and other devices with linear loads. The result was an essentially sinusoidal current in each phase and a current with a low neutral value at a frequency of 50/60Hz.

"Modern" appliances such as television sets, fluorescent lamps, video cameras and microwave ovens typically draw current for only a fraction of a cycle, causing non-linear loads and consequently non-linear currents. This generates strange harmonics in the 50/60Hz mains frequency. For this reason, the current in distribution cabinet transformers today contains not only a 50Hz (or 60Hz) component, but also a 150Hz (or 180Hz) component, a 250Hz (or 300Hz) component and other significant harmonic components up to 750Hz (or 900Hz) and beyond. **In this context, knowledge of the K factor is significantly important (see § 10.2.5).**

The value of the vector sum of the currents in a properly balanced system that feeds non-linear loads can still be quite low. However, the sum does not eliminate all harmonic currents. The **odd multiples of the third harmonic** (called "TRIPLENS") are added algebraically in the neutral and therefore **cause it to overheat even with symmetrical loads.**

#### 10.2.4. Consequence of the presence of harmonics

**Generally speaking, even harmonics, i.e. 2nd, 4th, 6th, etc. do not cause problems.**

The triple harmonics, odd multiples of three, add to the neutral (rather than cancelling), creating a potentially dangerous overheating situation of the conductor itself.

Designers should consider the following three points listed when designing a power distribution system containing harmonic currents:

- The neutral conductor must be adequately dimensioned.
- The distribution transformer must have an auxiliary cooling system in order to continue to operate at its rated power if it is not suitable for harmonics. This is necessary because the harmonic current in the neutral of the secondary circuit circulates in the delta-connected primary circuit. This circulating harmonic current causes the transformer to overheat.
- The phase harmonic currents are reflected on the primary circuit and return to the source. This can cause a distortion of the voltage waveform to such an extent that any power factor correction capacitors on the line can easily be overloaded.

The 5th and 11th order harmonics oppose the flow of current through the motors, making their operation more difficult and limiting their average life.

In general, the higher the order number of the harmonic the lower its energy, and therefore the lower its impact on the equipment (except for transformers)

#### 10.2.5. Parameters for the selection of electrical transformers - K factor

Supplying non-linear electrical loads can cause thermal and mechanical problems for power transformers. Current harmonics, in fact, **cause additional losses in the windings and vibrations**. These problems can lead to malfunctions and/or a reduction in the expected life of the transformer.

For example, continuous operation of a transformer at 10 °C beyond its insulation class leads to a reduction in lifetime of about 50%. The insulation of the transformer is sensitive to excessive temperatures, since it can lose its physical characteristics, which in the worst case can lead to a short circuit between the coils or to earth, and thus to a breakdown.

In order to safely supply a load with one or more non-linear equipment, the transformer must be suitably designed: the K factor is an index that defines its ability to supply a more or less non-linear load, avoiding excessive heating and ensuring continuity of service. It is defined by the following ratio **and is a parameter present in the harmonic analysis performed by the PQA924 instrument**:

$$K = \frac{\sum_{n=1}^{50} (I_n^2 * n^2)}{\sum_{n=1}^{50} I_n^2}$$

where:

$I_n$  = effective value of the harmonic current of order n

n = harmonic order

The higher the K-factor of a transformer, the more robust it is to non-linear loads. Once the K-factor of the load to be supplied is known, a transformer with a K-factor equal to or greater than that of the load must be chosen.

### 10.2.6. Interharmonics

While harmonics are signals with a frequency that is an integer multiple of the fundamental frequency, **interharmonics** are signals with a frequency that **is not an integer** multiple of the fundamental frequency.

Knowledge of interharmonics is still evolving, although there is a growing interest in this phenomenon due to the development of frequency converters and similar control devices.

As with harmonics, the order of an interharmonic is given by the ratio of the interharmonic and the fundamental frequency. There are two basic mechanisms for generating interharmonics. The first is related to the amplitude and/or phase modulation of the frequency of the supply voltage. The second mechanism is the asynchronous switching (i.e. not synchronised to the mains frequency) of semiconductor devices in static converters. Typical examples are cycloconverters and pulse-width modulation (PWM) converters. The loads that can cause interharmonics are:

- Loads based on electric arc technology, such as welding machines and electric arc furnaces
- Electric drives
- Static converters

**The PQA924 instrument performs voltage and current** interharmonic calculations.

A fundamental index for detecting the presence of voltage interharmonics is the Total Interharmonic Distortion parameter, **THIV%** value, defined as:

$$THIV\% = \frac{\sqrt{\sum_{h=2}^{40} V_{ih}^2}}{V_1} \times 100$$

### 10.3. INRUSH CURRENTS

The PQA924 allows you to detect and record events related to the inrush current, a typical phenomenon in the starting of rotating machines, but also used for other types of applications in the industrial plant sector (e.g. troubleshooting of load switches, sizing of protections, oscillating currents, etc.), as shown in the following figures:

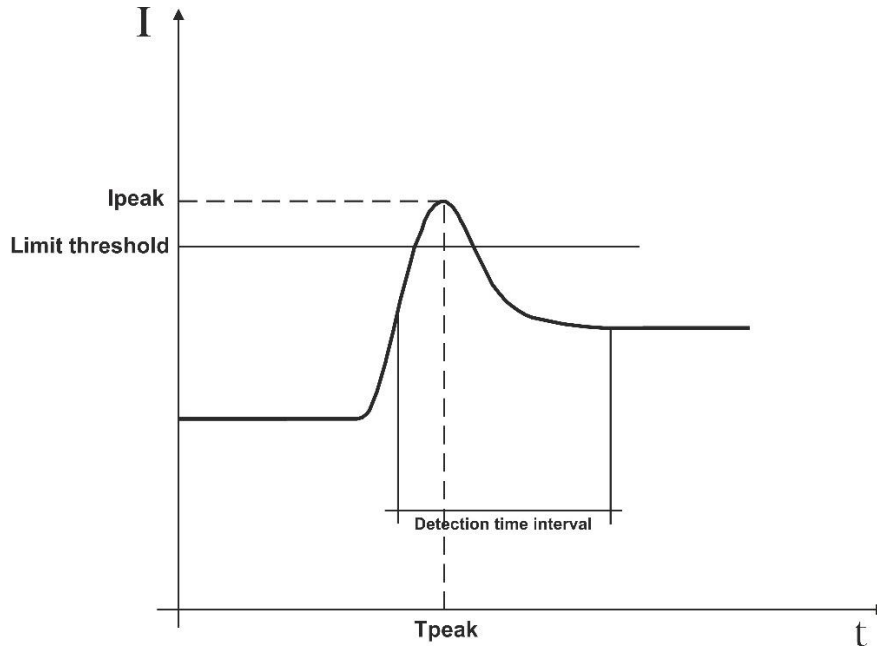

Fig. 89: Standard trend inrush current parameters

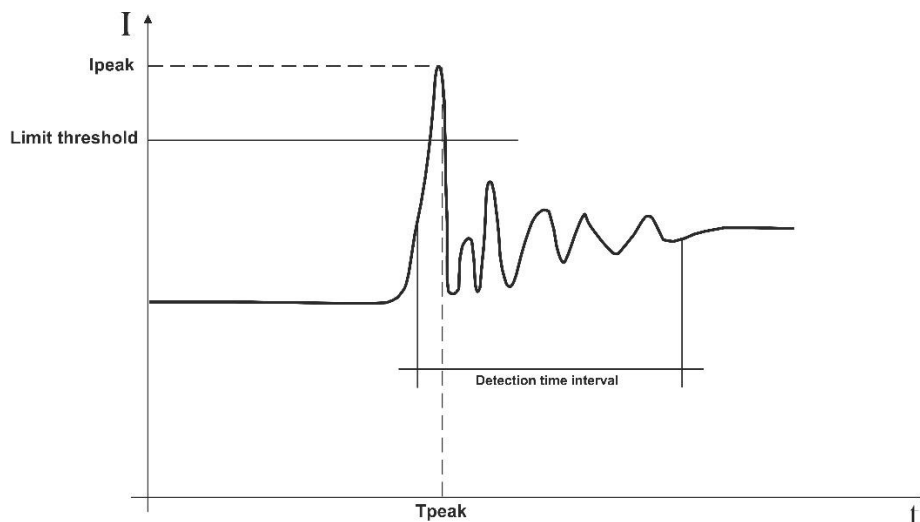

Fig. 90: Oscillating trend inrush current parameters

The instrument classifies as inrush currents all events characterised by phase currents exceeding a predetermined threshold. The maximum number of measurable events is **2000**.

When setting up the instrument prior to recording, the user can change the following parameters:

- **Current limit threshold:** Current value that involves the detection and storage of an event. The Max value that can be set is always equal to the full scale of the clamps used.

- **Detection modes:** The following modes are available:
- Fixed:** The instrument detects and stores an event when the RMS value of the current calculated for each period and updated every half period (10ms at 50Hz, 8.3ms at 60Hz) exceeds the value of the user-defined threshold. **In order for the instrument to be ready to detect a new event, the current must fall below the value of the set limit threshold.**
  - Var:** The instrument detects and stores an event whenever the RMS value of the current calculated every half period (10ms at 50Hz, 8.3ms at 60Hz) exceeds the previous RMS value (i.e. calculated in the previous half period) by an amount equal to the user-defined limit threshold.
- **Observation interval:** When the instrument detects an event, it stores 100 RMS values of the current and 100 RMS values of the corresponding voltage within the specified observation interval. The available values are in the **0.2s ÷ 10.0s** range in steps of **0.2s**.

**CAUTION**

The display of events is **only possible within the HTAgorà software**

The results can only be analysed by downloading the data to a PC and using the HTAgorà software. In particular, the following values are shown:

- **Numerical table of measured events** (phase in which the event occurred, date/time in which the event occurred, maximum value among the TRMs values calculated in a half period during the observation interval, assumed value of the last value belonging to the observation interval).
- **Graphic window of measured events** (graph of the 100 stored TRMS values of the current and corresponding voltage during the observation interval for each row of the numerical table).



#### 10.4. VOLTAGE FLICKER

In electrical engineering, "**Flicker**" is caused by sudden and repetitive changes in the mains voltage. It is caused by the frequent plugging and unplugging of loads and manifests itself as a disturbance with a visual impression of instability (flicker) in the luminance of the luminaires. This disturbance must be monitored according to the requirements of the reference standard **IEC/EN61000-4-15** which requires that the **long-term severity of the flicker disturbance shall not be greater than 1 for 95% of the observation time.**

The causes of this disturbance are often due to the connection and disconnection of large loads connected to the network that work discontinuously (a typical phenomenon in foundries or industrial arc welding machines).

In order to assess the control of this random phenomenon, a **Pst** quantity has been introduced, based on measurements of the mains voltage. It is defined as **the severity of the short-term flicker**, due to the "short" acquisition time (**10min**) of the mains voltage necessary to carry out the analysis. The PST is obtained statistically by analysing the mains voltage appropriately.

Electricity distribution companies must also comply with specific requirements in relation to this disturbance. **The PQA924 instrument** derives the distorted signal with respect to the ideal one and carries out a statistical analysis from which it derives the following quantities:

- **Pinst** → Instantaneous Flicker value calculated in real time
- **Pst** → **Short-Term** Flicker severity, calculated with **10-Minute** integration periods
- **Plt** → **Long-term** Flicker severity, calculated starting from a sequence of 12 Pst values over a 2-hour interval according to the following formula:

$$P_{lt} = \sqrt[3]{\sum_{i=1}^{12} \frac{P_{sti}^3}{12}}$$

### 10.5. VOLTAGE DISSYMMETRY

Under normal conditions the supply voltages are symmetrical and the loads balanced. Dissymmetry and unbalances occur in the event of faults (broken insulation) and phase interruptions. Moreover, with single-phase loads, the balance can only be of a statistical type.

It is necessary to study the three-phase network also under abnormal fault conditions in order to dimension the protection devices. The system of equations derived from Kirchhoff's principles can be used, but to apply the considerations and formulae of balanced systems, and also to better understand the contribution of the plant components, the theory of symmetric components is useful.

It can be shown that any set of three vectors can be decomposed into three sets: the direct symmetric, the inverse symmetric and the homopolar as shown in the following figure:

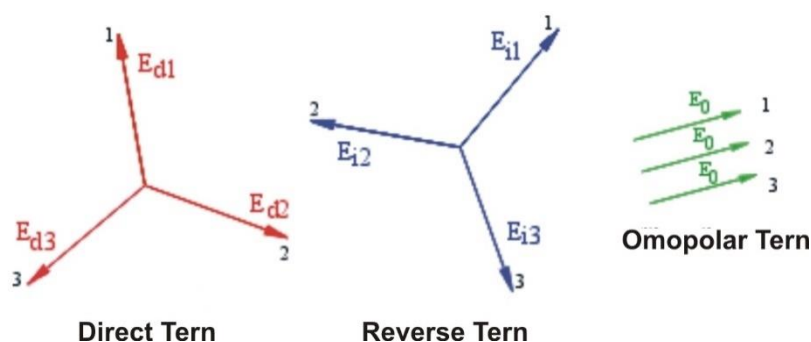

Fig. 91: Breakdown of a set of three vectors

From this it follows that any three-phase system which is nonetheless **dissymmetrical and unbalanced** can be broken down into 3 three-phase systems which can be traced back to the separate study of three single-phase circuits corresponding to the **direct, inverse and homopolar sequences** respectively.

The EN50160 standard defines, with regard to LV electrical systems, that "*under normal operating conditions for each period of one week, 95% of the average effective values, calculated in 10 minutes, of the reverse sequence component of the supply voltage must be in the range between 0 and 2% of the direct sequence component. In some regions, where user systems are connected to partially single-phase or two-phase lines, imbalances of up to approximately 3% may occur at the three-phase power terminals.*

**The PQA924 instrument measures and records** the following parameters that define the percentage of unevenness on the voltages of an electrical system:

$$u_2\% = \frac{E_i}{E_d} * 100 \rightarrow \text{reverse sequence component}$$

$$u_0\% = \frac{E_0}{E_d} * 100 \rightarrow \text{homopolar sequence component}$$

where:

- E<sub>i</sub> = sequence of the reverse set of three vectors
- E<sub>d</sub> = sequence of the direct set of three vectors
- E<sub>0</sub> = sequence of the homopolar set of three vectors

## 10.6. FAST VOLTAGE TRANSIENTS

The PQA924 instrument saves as fast voltage transients (spikes) all phenomena associated with phase voltages under the following conditions

- Fast changes in the slope of the voltage waveform with a sampling time of **1 $\mu$ s** with a maximum amplitude of  **$\pm 8$ kV**
- Exceeding a limit threshold of variation set by the user
- Event within a user-defined time detection window between **100 $\mu$ s** and **1ms**

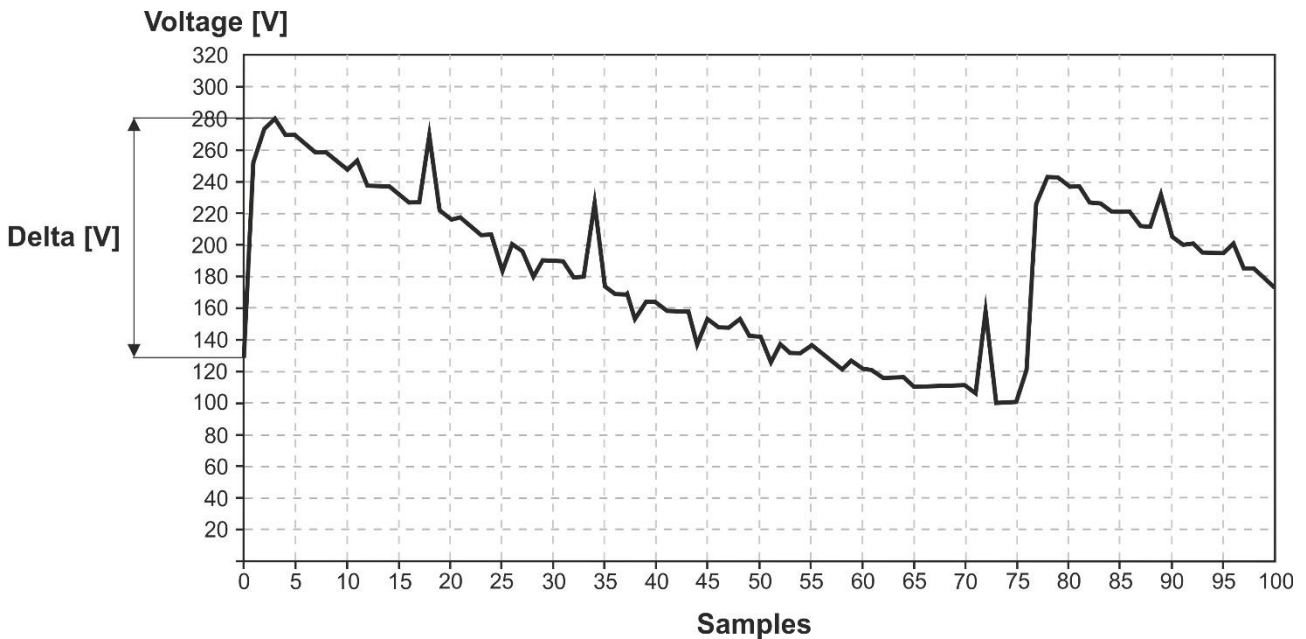

Fig. 92: Fast voltage transient analysis

In general, the voltage transient detection routine occurs as follows:

1. The instrument detects the exceeding of **the variation threshold set in 1 $\mu$ s** (e.g. with threshold = 200V  $\rightarrow$ , if the slope of the signal is such that the variation is greater than 200V/ $\mu$ s  $\rightarrow$ , the event is detected)
2. The instrument always measures **1000 samples of 1 $\mu$ s** of the signal which then subsamples according to the observation window set and stores **only 100** (see Fig. 92) in order to save internal memory (for example, if Window = 100 $\mu$ s  $\rightarrow$  spike detected and 100 values available with 1 $\mu$ s resolution; if Window = 200 $\mu$ s  $\rightarrow$  spike detected and 100 values available with 2 $\mu$ s resolution and so on)
3. The instrument stores a **Delta [V]** equal to **the difference between the instantaneous value of the pre-spike voltage and peak value of the spike** (see Fig. 92)
4. The instrument stores the start date/time of the event, the voltage delta reached and the phase in which the event occurred

The maximum total number of events measurable by the instrument during a recording is **2000**



### CAUTION

The display of events is **only possible within the HTAgorà software**

### 10.7. CALCULATED NETWORK PARAMETER DEFINITIONS

Referring to a generic **3-Phase 4 Wires** system, the instrument calculates the values of the network parameters on the basis of **Ns samples** taken over **Nc cycles** (10 cycles @50Hz / 12 cycles @60Hz ) of the voltage and current signals using the following ratio:

| Parameter                                   | Description   | Calculation model   |
|---|---|---|
| VLx-N (x= 1,2,3)                            | RMS Phase-Neutral Voltage   | $V_{Lx-N} = \sqrt{\frac{1}{N_{SC}} * \sum_{s=0}^{N_{SC}-1} (v_s^{Lx-N})^2}$   |
| VLx-Ly<br>(x,y= 1,2-2,3-3,1)                | RMS Phase-Phase Voltage   | $V_{Lx-Ly} = \sqrt{\frac{1}{N_{SC}} * \sum_{s=0}^{N_{SC}-1} (v_s^{Lx-N} - v_s^{Ly-N})^2}$                                     |
| Ix (x= 1,2,3,N)                             | RMS Phase and Neutral Currents  | $I_{Lx} = \sqrt{\frac{1}{N_{SC}} \sum_{s=0}^{N_{SC}-1} (i_s^x)^2}$  |
| Amplitude/Phase Voltage Harmonics (h order) | FFT on Nsc samples → Vectors of complex numbers   |   |
|   | $\vec{V}_{Lx-N}^h = \{(Re[\vec{V}_{Lx-N}^h]; Im[\vec{V}_{Lx-N}^h]); h = 0,1, \dots, OrdMax\}, x=1,2,3$ $Amplitude  \vec{V}_{Lx-N}^h  = \sqrt{(Re[\vec{V}_{Lx-N}^h])^2 + (Im[\vec{V}_{Lx-N}^h])^2}$ $Phase (\vec{V}_{Lx-N}^h) = atan2(Re[\vec{V}_{Lx-N}^h]; Im[\vec{V}_{Lx-N}^h])$ |   |
| Amplitude/Phase Current Harmonics (h order) | FFT on Nsc samples → Vectors of complex numbers   |   |
|   | $\vec{I}_{Lx}^h = \{(Re[\vec{I}_{Lx}^h], Im[\vec{I}_{Lx}^h]); h = 0,1, \dots, OrdMax\} x=1,2,3,N$ $Amplitude  \vec{I}_{Lx}^h  = \sqrt{(Re[\vec{I}_{Lx}^h])^2 + (Im[\vec{I}_{Lx}^h])^2}$ $Phase (\vec{I}_{Lx}^h) = atan2(Re[\vec{I}_{Lx}^h]; Im[\vec{I}_{Lx}^h])$                  |   |
| PLx (x= 1,2,3)                              | Active Power of Phase   | $P_{Lx} = \frac{1}{N_{SC}} \sum_{s=0}^{N_{SC}-1} v_s^{Lx-N} * i_s^{Lx}$   |
| SLx (x= 1,2,3)                              | Apparent Power of Phase   | $S_{Lx} = V_{Lx-N} * I_{Lx}$  |
| QLx (x= 1,2,3)                              | Reactive Power of Phase   | $Q_{Lx} = sign\{Q_{Lx}\} * \sqrt{(S_{Lx})^2 - (P_{Lx})^2}$  |
| PFLx (x = 1,2,3)                            | Power Factor of Phase   | $PF_{Lx} = \frac{P_{Lx}}{S_{Lx}}$   |
| cosφLx<br>(x = 1,2,3)                       | Displacement Phase Power Factor → phase displacement between voltage and current fundamentals of phase x  | ()* = conjugated complex  |
|   |   | $\cos \varphi_{Lx} = \frac{Re\{\vec{V}_{Lx-N}^{h=1} \times (I_{Lx}^{h=1})^*\}}{ \vec{V}_{Lx-N}^{h=1}  \times  I_{Lx}^{h=1} }$ |

| Parameter                                      | Description  | Calculation model  |
|--|--|--|
| $P_{TOT}$                                      | Total Active Power   | $P_{TOT} = P_{L1} + P_{L2} + P_{L3}$   |
| $Q_{TOT}$                                      | Total Reactive Power   | $Q_{TOT} = Q_{L1} + Q_{L2} + Q_{L3}$   |
| $S_{TOT}$                                      | Total Apparent Power   | $S_{TOT} = \sqrt{(P_{TOT})^2 + (Q_{TOT})^2}$   |
| $PF_{TOT}$                                     | Total Power Factor   | $PF_{TOT} = \frac{P_{TOT}}{S_{TOT}}$   |
| $P_{TOT} (h=1)$                                | Total Active Power referred to fundamental V/I   | $P_{TOT}^{h=1} = \sum_{x=1,2,3} Re\{\bar{V}_{Lx-N}^{h=1} \times (I_{Lx}^{h=1})^*\}$    |
| $Q_{TOT} (h=1)$                                | Total Reactive Power referred to fundamental V/I   | $Q_{TOT}^{h=1} = \sum_{x=1,2,3} Im\{\bar{V}_{Lx-N}^{h=1} \times (I_{Lx}^{h=1})^*\}$    |
| $\cos\phi_{TOT}$                               | Total displacement power factor  | $\cos \phi_{TOT} = \frac{P_{TOT}^{h=1}}{\sqrt{(P_{TOT}^{h=1})^2 + (Q_{TOT}^{h=1})^2}}$ |
| Volateg<br>dissymetry<br>(FFT harmonic<br>h=1) | $\bar{V}_d = \frac{1}{3} \times (\bar{V}_{L1-N}^{h=1} + \alpha \times \bar{V}_{L2-N}^{h=1} + \alpha^2 \times \bar{V}_{L3-N}^{h=1})$ $\bar{V}_i = \frac{1}{3} \times (\bar{V}_{L1-N}^{h=1} + \alpha^2 \times \bar{V}_{L2-N}^{h=1} + \alpha \times \bar{V}_{L3-N}^{h=1})$ $\bar{V}_0 = \frac{1}{3} \times (\bar{V}_{L1-N}^{h=1} + \bar{V}_{L2-N}^{h=1} + \bar{V}_{L3-N}^{h=1})$ $u2 = \frac{ \bar{V}_i }{ \bar{V}_d }, u0 = \frac{ \bar{V}_0 }{ \bar{V}_d }$ where:<br>$\alpha = -\frac{1}{2} + j\frac{\sqrt{3}}{2}$ |  |

### CAUTION



- Strictly speaking, the expression of reactive power in **non-sinusoidal** mode would not be correct. To understand why, it may be useful to consider that both the presence of harmonics and the presence of reactive power cause, among other effects, an increase in line power losses due to the increase in the RMS value of the current. In the above formula, the term of the increase in power losses due to harmonics is algebraically added to that introduced by the presence of reactive power. In fact, although both phenomena contribute to an increase in line losses, it is not generally true that these causes of power losses are in phase with each other and therefore algebraically summable
- **The  $\cos\phi$  parameter (Displacement Power Factor) represents the theoretical limit value that the Power Factor can reach if all harmonics can be completely eliminated from the electrical system. This parameter is the one to which reference should be made in the management of plant power factor correction problems**

### 10.7.1. Conventions on powers and power factors

The conventions used to identify the type of reactive power, the type of power factor, the direction of active power and the direction of reactive power are shown in the following diagram (according to IEC/EN 61557-12)

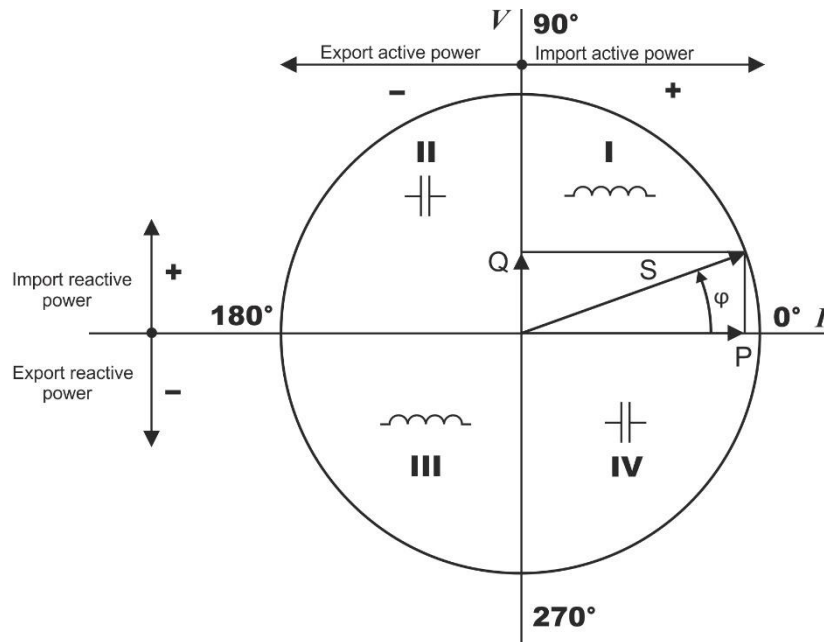
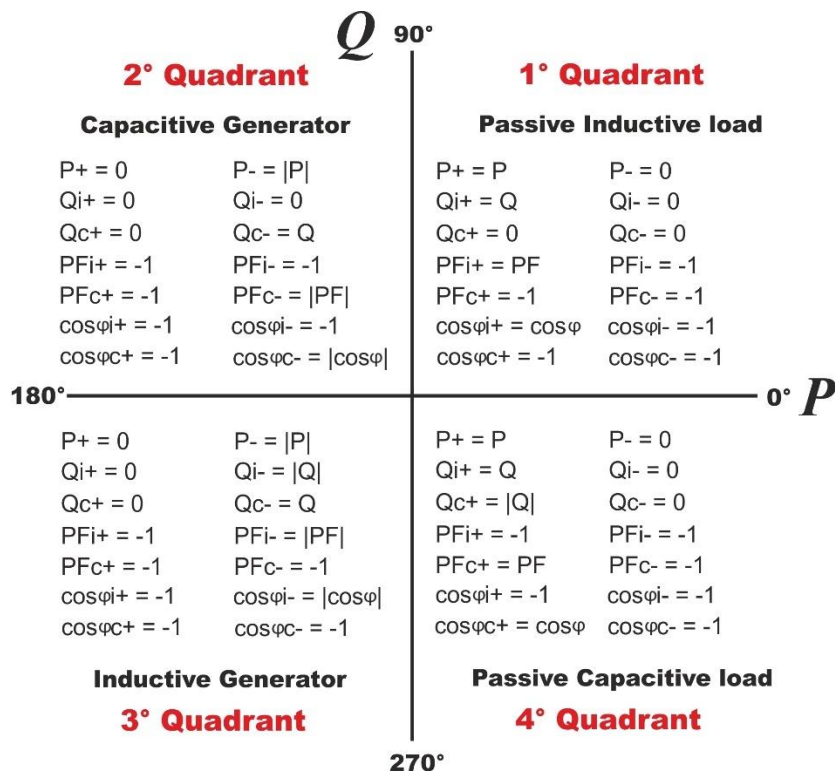

Fig. 93: Voltage, Current and Powers diagrams and related conventions

The following indications must be considered:

- The reference of the diagram is the current "I" shown to the right side of the axis
- The voltage "V" varies with respect to the current as a function of the phase angle  $\varphi$
- The phase angle  $\varphi$  between current and voltage is considered positive in an **anti-clockwise** direction

Based on the diagram shown in Fig. 93, the behaviour of the active powers, reactive powers, power factor and  $\cos\varphi$  are shown in the following diagram



The meaning of the symbols used and the values assumed by them in the diagram above is shown in the following tables:

| SYMBOL | DESCRIPTION                            | NOTES   |
|--------|--|---|
| P+     | Active power +                         | Positive values for quantities (Absorption condition) |
| PFC+   | Capacitive power factor +              |   |
| PFI+   | Inductive power factor +               |   |
| cosφC+ | Capacitive displacement power factor + |   |
| cosφI+ | Inductive displacement power factor +  |   |
| QC+    | Capacitive reactive power +            |   |
| QI+    | Inductive reactive power +             | Negative values for quantities (Generation condition) |
| P-     | Active power -                         |   |
| PFC-   | Capacitive power factor -              |   |
| PFI-   | Inductive Power Factor -               |   |
| cosφC- | Capacitive displacement power factor - |   |
| cosφI- | Inductive displacement power factor -  |   |
| QC-    | Capacitive reactive power -            |   |
| QI-    | Inductive reactive power -             |   |

| VALUE | DESCRIPTION  |
|-------|--|
| P     | The relative active power (positive or negative) is defined in the relevant dial and therefore takes the value of the active power at that moment  |
| Q     | The relative reactive power (inductive or capacitive, positive or negative) is defined in the relevant dial and therefore takes the value of the reactive power at that moment                           |
| PF    | The relative power factor (inductive or capacitive, positive or negative) is defined in the relevant dial and therefore takes the value of the Power Factor at that moment                               |
| cosφ  | The relative displacement power factor (inductive or capacitive, positive or negative) in the relevant dial and therefore takes the value of the displacement power factor at that moment                |
| 0     | The relative active power (positive or negative) or reactive power (inductive or capacitive, positive or negative) <b>is NOT defined in the relative dial</b> and therefore zero.                        |
| -1    | The relative power factor (inductive or capacitive, positive or negative) <b>is NOT defined in the relative (this condition is often due to an incorrect connection of the clamps on the conductors)</b> |

**10.7.2. ARON INSERTION**

In distributed electrical systems without a neutral, phase voltages, power factors and phase cosines  $\phi$  lose their meaning and only the phase-to-phase voltages, phase currents and total power remain defined.

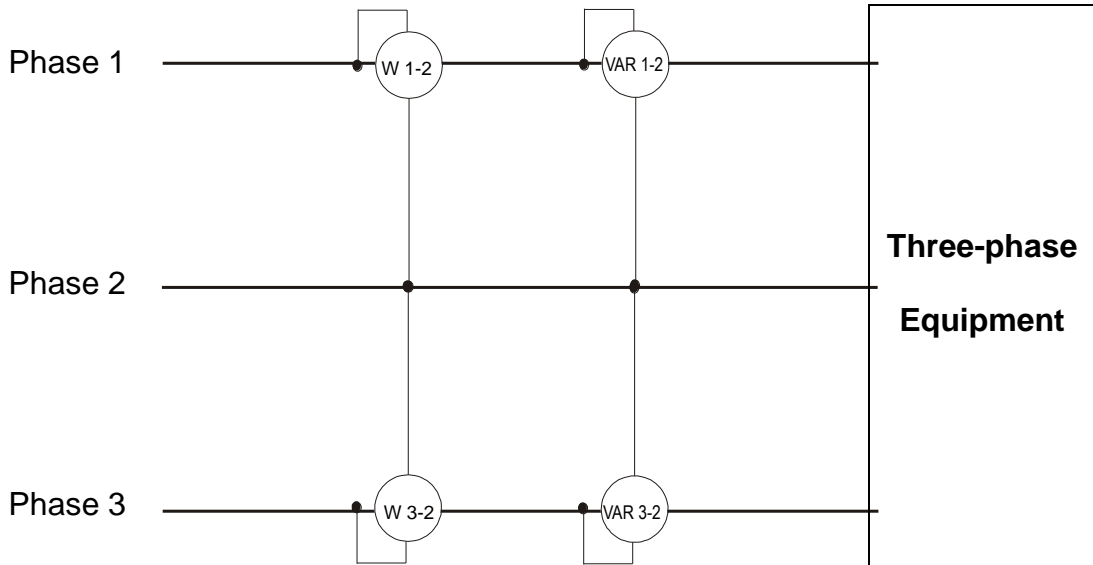

In this case, the potential of one of the three phases (e.g. phase 2) is taken as the reference potential and the values of total active, reactive and apparent power are expressed as the sum of the readings of the pairs of Wattmeters, VARmeters and VAmeters.

$$P_{TOT} = W_{1-2} + W_{3-2}$$

$$Q_{TOT} = VAR_{1-2} + VAR_{3-2}$$

$$S_{TOT} = \sqrt{(W_{1-2} + W_{3-2})^2 + (VAR_{1-2} + VAR_{3-2})^2}$$



### 10.8. CONNECTING THE INSTRUMENT WITH EXTERNAL CTS

The PQA924 also allows current measurements to be made in three-phase systems (typical of MV/LV systems) where they are present on the lines of **Current Transformers (CTs)** with a transformation ratio of **xxx/1A** or **xxx/5A**.

Under these conditions, in order to evaluate the current on the phase conductors, it is necessary to carry out a manual calculation based on the value measured on the secondary circuit of the CT, using special clamps with low currents and good recording uncertainty, and the value of the transformation ratio of the same.

The instrument allows the **direct** reading of the phase and neutral currents, with the appropriate programming of the parameters, without the need for any manual calculation, based on the connection shown in the following figure, relating to a Three-phase four-wire system:

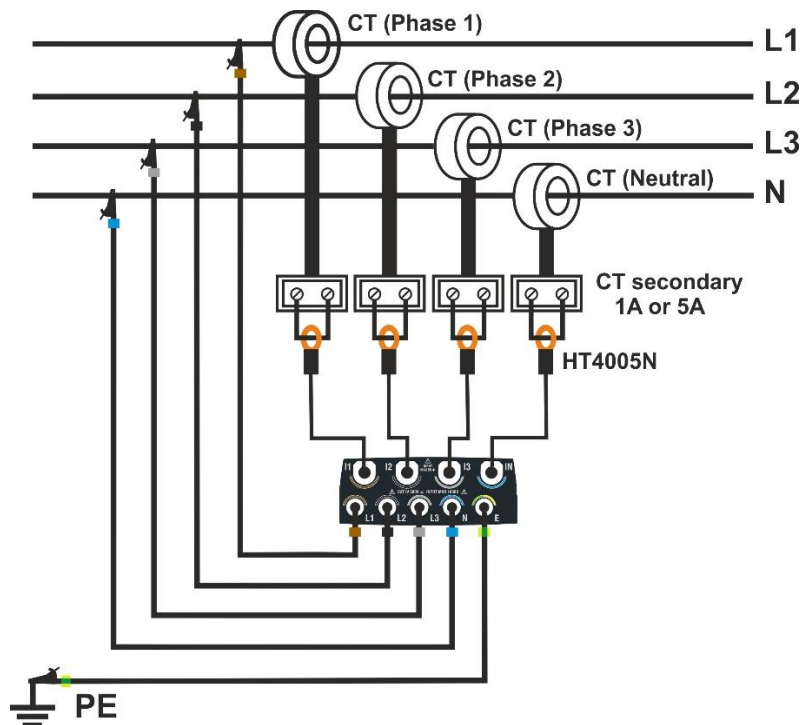

Fig. 94: Instrument connection diagram with external CTs

As can be seen in Fig. 94, the secondary circuits of the CTs **must be short-circuited** and a clamp-on transducer (one for each phase + neutral) must be inserted in this loop to read the relative current. The **HT4005N model is recommended** for use in the 5A range. The outputs of these clamps must then be connected to the inputs **I1, I2, I3, IN** of the instrument. In the programming mode (see § 5.2.2), it is necessary to set the following:

- **Primary** current of CTs (ex: 300A) present on Phases L1, L2, L3
- **Secondary** current of the CTs (ex: 5A) present on Phases L1, L2, L3
- **Primary** current of the CT (ex: 300A) present on Neutral N
- **Secondary** current of the CT (ex: 5A) present on Neutral N
- Full scale of the clamp present on the secondary circuit of the CT on Phases L1, L2, L3
- Full scale of the clamp present on the secondary circuit of the CT on Neutral N

On the basis of these parameters, the instrument calculates and displays the value of the currents on the phases L1, L2, L3 and on the neutral N as a function of the value of the currents measured by the clamp present on the secondary circuit of the CTs.

## 10.9. MEASUREMENT METHOD

The instrument can measure: voltages, currents, active powers, capacitive and inductive reactive powers, apparent powers, capacitive and inductive power factors, energies, etc. All these quantities are analysed digitally (conversion of six analogue signals of voltages and currents) and calculated internally on the basis of the formulas described in the previous sections.

Storing all the sampled data in real time would require unmanageable storage capacity. For this reason, a storage method was sought which, while providing significant data, would also allow a distinction to be made between the information to be stored.

The chosen method is that of integration (or aggregation): after a defined **Integration period** (or **aggregation interval**), the instrument extracts the following values from the sampled values of each quantity to be stored:

- **MINIMUM** value of the quantity in the integration period (harmonics excluded).
- **AVERAGE** value of the quantity (understood as the arithmetic average of all the values recorded during the Integration Period).
- **MAXIMUM** value of the quantity in the integration period (harmonics excluded).

These three pieces of information (repeated for each quantity to be stored) are stored in the memory together with the time and date of the start of the period for the entire duration of the recording. At the end of storage, the instrument begins to acquire measurements again for a new period. The result (**visible only within the HTAgorà software**) is a numerical and graphical representation of the values, where each row corresponds to an integration period over the entire duration of the recording.

The IEC/EN61000-4-30 Class S standard requires different integration periods (or aggregation intervals) for the various calculated quantities. In detail:

- **Periodic analysis parameters (voltages, currents, powers, power factors, energies, etc.)** Main integration → period selectable between the values:  
**0.2s, 3s, 10s, 15s, 18s, 30s, 1min, 5min, 10min, 15 min, 30min, 60min, 120min**
- **Frequency parameter** → Integration period selectable within the range: **3s ÷ 30s** in steps of **1s**
- **Harmonic analysis parameter** Integration → period selectable between the values:  
**0.2s, 3s, 6s, 10s, 12s, 18s, 30s, 1min, 5min, 10min, 15min, 30min, 60min, 120min**
- **Flicker voltages** Integration → period fixed at **10min**



### CAUTION

When setting the possible duration of a recording, pay attention to the different integration periods set for the different quantities in order to obtain correct results

## 11. SERVICE

### 11.1. WARRANTY CONDITIONS

This instrument is guaranteed against defects in materials and workmanship in accordance with the General Conditions of Sale. During the warranty period, all defective parts may be replaced and the manufacturer reserves the right to repair or replace the product. If the instrument is to be returned to the after-sales service or to a dealer transportation costs shall be borne by the Customer. However, shipment must be agreed upon. Any instrument returned must be accompanied by a report stating the reasons for the return. Only the original packaging material can be used to ship the instrument; any damage caused by non-original packaging will be charged to the Customer. The manufacturer declines all responsibility for damage caused to persons and/or property.

The warranty does not apply in the following cases:

- Repair and/or replacement of accessories and battery (not covered by warranty).
- Any repairs that may be required as a result of misuse of the instrument or use with incompatible equipment.
- Any repair that may be required as a result of improper packaging.
- Any repair that may be required as a result of servicing by unauthorised personnel.
- Any modification made to the instrument without the manufacturer's authorisation.
- Any use not specified in the specifications of the instrument or in the instruction manual.

The contents of this manual may not be reproduced in any form whatsoever without the authorisation of the manufacturer.

**All our products are patented and their trademarks registered. The manufacturer reserves the right to modify the product specifications and prices if this is aimed at technological improvements.**

### 11.2. SERVICE

If the instrument does not work properly, check the condition of the cables and clamps and replace them if necessary before contacting the Customer Support Service. If the instrument continues to malfunction, check that it is being used correctly and as instructed in this manual. If the instrument is to be returned to the after-sales service or to a dealer transportation costs shall be borne by the Customer. However, shipping must be agreed upon in advance. Any instrument returned must be accompanied by a report stating the reasons for the return. Only use the original packaging for shipping. Any damage caused by the use of non-original packaging will be charged to the Customer.



**HT ITALIA SRL**

Via della Boaria, 40  
48018 – Faenza (RA) – Italy  
T +39 0546 621002 | F +39 0546 621144  
M [ht@ht-instruments.com](mailto:ht@ht-instruments.com) | [www.ht-instruments.it](http://www.ht-instruments.it)

WHERE  
WE ARE



**HT INSTRUMENTS SL**

C/ Legalitat, 89  
08024 Barcelona – Spain  
T +34 93 408 17 77 | F +34 93 408 36 30  
M [info@htinstruments.es](mailto:info@htinstruments.es) | [www.ht-instruments.com/es-es/](http://www.ht-instruments.com/es-es/)

**HT INSTRUMENTS GmbH**

Am Waldfriedhof 1b  
D-41352 Korschenbroich – Germany  
T +49 (0) 2161 564 581 | F +49 (0) 2161 564 583  
M [info@ht-instruments.de](mailto:info@ht-instruments.de) | [www.ht-instruments.de](http://www.ht-instruments.de)