

DC Programmable Electronic Loads

Series IT8700 User Manual



Model: IT8722/IT8723/IT8731/IT8732/IT8733/
IT8722B/IT8732B/IT8733B/
IT8722P/IT8723P/IT8731P/IT8732P/IT8733P/
IT8722BP/IT8732BP/IT8733BP/
IT8702/IT8703/IT8701P/IT8702P/IT8703P
Version: 4.4

Notices

© Itech Electronic, Co., Ltd. 2021
No part of this manual may be reproduced in any form or by any means (including electronic storage and retrieval or translation into a foreign language) without prior permission and written consent from Itech Electronic, Co., Ltd. as governed by international copyright laws.

Manual Part Number

IT8700-402216

Revision

Fourth Edition, July. 1, 2021

Itech Electronic, Co., Ltd.

Trademarks

Pentium is U.S. registered trademarks of Intel Corporation.

Microsoft, Visual Studio, Windows and MS Windows are registered trademarks of Microsoft Corporation in the United States and/or other countries and regions.

Warranty

The materials contained in this document are provided “as is”, and is subject to change, without prior notice, in future editions. Further, to the maximum extent permitted by applicable laws, ITECH disclaims all warranties, either express or implied, with regard to this manual and any information contained herein, including but not limited to the implied warranties of merchantability and fitness for a particular purpose. ITECH shall not be held liable for errors or for incidental or indirect damages in connection with the furnishing, use or application of this document or of any information contained herein. Should ITECH and the user enter into a separate written agreement with warranty terms covering the materials in this document that conflict with these terms, the warranty terms in the separate agreement shall prevail.

Technology Licenses

The hardware and/or software described herein are furnished under a license and may be used or copied only in accordance with the terms of such license.

Restricted Rights Legend

Restricted permissions of the U.S. government. Permissions for software and technical data which are authorized to the U.S. Government only include those for custom provision to end users. ITECH follows FAR 12.211 (technical data), 12.212 (computer software). DFARS 252.227-7015 (technical data--commercial products) for national defense and DFARS 227.7202-3 (permissions for commercial computer software or computer software documents) while providing the customized business licenses of software and technical data.

Safety Notices

CAUTION

A CAUTION sign denotes a hazard. It calls attention to an operating procedure or practice that, if not correctly performed or adhered to, could result in damage to the product or loss of important data. Do not proceed beyond a CAUTION sign until the indicated conditions are fully understood and met.

WARNING

A WARNING sign denotes a hazard. It calls attention to an operating procedure or practice that, if not correctly performed or adhered to, could result in personal injury or death. Do not proceed beyond a WARNING sign until the indicated conditions are fully understood and met.



NOTE

A NOTE sign denotes important hint. It calls attention to tips or supplementary information that is essential for users to refer to.

Quality Certification and Assurance

We certify that series IT8700 electronic load meets all the published specifications at time of shipment from the factory.

Warranty

ITECH warrants that the product will be free from defects in material and workmanship under normal use for a period of one (1) year from the date of delivery (except those described in the Limitation of Warranty below).

For warranty service or repair, the product must be returned to a service center designated by ITECH.















- The product returned to ITECH for warranty service must be shipped PREPAID. And ITECH will pay for return of the product to customer.
- If the product is returned to ITECH for warranty service from overseas, all the freights, duties and other taxes shall be on the account of customer.

Limitation of Warranty

This Warranty will be rendered invalid in case of the following:

- Damage caused by circuit installed by customer or using customer own products or accessories;
- Modified or repaired by customer without authorization;
- Damage caused by circuit installed by customer or not operating our products under designated environment;
- The product model or serial number is altered, deleted, removed or made illegible by customer;
- Damaged as a result of accidents, including but not limited to lightning, moisture, fire, improper use or negligence.

Safety Symbols

	Direct current		ON (power on)
	Alternating current		OFF (power off)
	Both direct and alternating current		Power-on state
	Protective conductor terminal		Power-off state
	Earth (ground) terminal		Reference terminal
	Caution, risk of electric shock		Positive terminal
	Warning, risk of danger (refer to this manual for specific Warning or Caution information)		Negative terminal
	Frame or chassis terminal	-	-

Safety Precautions

The following safety precautions must be observed during all phases of operation of this instrument. Failure to comply with these precautions or specific warnings elsewhere in this manual will constitute a default under safety standards of design, manufacture and intended use of the instrument. ITECH assumes no liability for the customer's failure to comply with these precautions.

WARNING

- Do not use the instrument if it is damaged. Before operation, check the casing to see whether it cracks. Do not operate the instrument in the presence of inflammable gasses, vapors or dusts.
- The electronic load is provided with a three-core power line during delivery and should be connected to a three-core junction box. Before operation, be sure that the instrument is well grounded.
- Make sure to use the power cord supplied by ITECH.
- Check all marks on the instrument before connecting the instrument to power supply.
- Use electric wires of appropriate load. All loading wires should be capable of bearing maximum short-circuit current of electronic load without overheating. If there are multiple electronic loads, each pair of the power cord must be capable of bearing the full-loaded rated short-circuit output current
- Ensure the voltage fluctuation of mains supply is less than 10% of the working voltage range in order to reduce risks of fire and electric shock.
- Do not install alternative parts on the instrument or perform any unauthorized modification.
- Do not use the instrument if the detachable cover is removed or loosen.
- To prevent the possibility of accidental injuries, be sure to use the power adapter supplied by the manufacturer only.
- We do not accept responsibility for any direct or indirect financial damage or loss of profit that might occur when using the instrument.
- This instrument is used for industrial purposes, do not apply this product to IT power supply system.
- Never use the instrument with a life-support system or any other equipment subject to safety requirements.

CAUTION

- Failure to use the instrument as directed by the manufacturer may render its protective features void.
- Always clean the casing with a dry cloth. Do not clean the internals.
- Make sure the vent hole is always unblocked.

Environmental Conditions

The instrument is designed for indoor use and an area with low condensation. The table below shows the general environmental requirements for the instrument. The speed of fan will change intelligently by the temperature of radiator. When the temperature is up to 40°C, the fan will be on and adjust intelligently when temperature changes.



Environmental Conditions	Requirements
Operating temperature	0°C to 40°C
Operating humidity	20%-80% (non-condensation)
Storage temperature	-20°C to 70 °C
Altitude	Operating up to 2,000 meters
Pollution degree	Pollution degree 2
Installation category	II



Note

To make accurate measurements, allow the instrument to warm up for 30 min before operation.

Regulatory Markings

	<p>The CE mark indicates that the product complies with all the relevant European legal directives. The specific year (if any) affixed refers to the year when the design was approved.</p>
	<p>The instrument complies with the WEEE Directive (2002/96/EC) marking requirement. This affixed product label indicates that you must not discard the electrical/electronic product in domestic household waste.</p>
	<p>This symbol indicates the time period during which no hazardous or toxic substances are expected to leak or deteriorate during normal use. The expected service life of the product is 10 years. The product can be used safely during the 10-year Environment Friendly Use Period (EFUP). Upon expiration of the EFUP, the product must be immediately recycled.</p>

Waste Electrical and Electronic Equipment (WEEE) Directive



2002/96/EC Waste Electrical and Electronic Equipment (WEEE) Directive

This product complies with the WEEE Directive (2002/96/EC) marking requirement. This affix product label indicates that you must not discard the electrical/electronic product in domestic household waste.
Product Category

With reference to the equipment classifications described in the Annex I of the WEEE Directive, this instrument is classified as a “Monitoring and Control Instrument”.

To return this unwanted instrument, contact your nearest ITECH office.

Compliance Information

Complies with the essential requirements of the following applicable European Directives, and carries the CE marking accordingly:

- Electromagnetic Compatibility (EMC) Directive 2014/30/EU
- Low-Voltage Directive (Safety) 2014/35/EU

Conforms with the following product standards:

EMC Standard

IEC 61326-1:2012/ EN 61326-1:2013 ¹²³

Reference Standards

CISPR 11:2009+A1:2010/ EN 55011:2009+A1:2010 (Group 1, Class A)

IEC 61000-4-2:2008/ EN 61000-4-2:2009

IEC 61000-4-3:2006+A1:2007+A2:2010/ EN 61000-4-3:2006+A1:2008+A2:2010

IEC 61000-4-4:2004+A1:2010/ EN 61000-4-4:2004+A1:2010

IEC 61000-4-5:2005/ EN 61000-4-5:2006

IEC 61000-4-6:2008/ EN 61000-4-6:2009

IEC 61000-4-11:2004/ EN 61000-4-11:2004

1. The product is intended for use in non-residential/non-domestic environments. Use of the product in residential/domestic environments may cause electromagnetic interference.
2. Connection of the instrument to a test object may produce radiations beyond the specified limit.
3. Use high-performance shielded interface cable to ensure conformity with the EMC standards listed above.

Safety Standard

IEC 61010-1:2010/ EN 61010-1:2010

Content

QUALITY CERTIFICATION AND ASSURANCE.....	I
WARRANTY.....	I
LIMITATION OF WARRANTY	I
SAFETY SYMBOLS	I
SAFETY PRECAUTIONS	II
ENVIRONMENTAL CONDITIONS	III
REGULATORY MARKINGS	III
WASTE ELECTRICAL AND ELECTRONIC EQUIPMENT (WEEE) DIRECTIVE.....	III
COMPLIANCE INFORMATION.....	V
CHAPTER1 INSPECTION AND INSTALLATION.....	1
1.1 VERIFYING THE SHIPMENT.....	1
1.2 INSTALLATION SIZE INTRODUCTION.....	1
1.3 MODULE INSTALLATION	8
1.3.1 Channel number.....	9
1.4 MAINFRAME INSTALLATION	10
1.5 CONNECTING THE POWER CORD	10
1.6 CONNECTING THE DEVICE UNDER TEST.....	12
CHAPTER2 QUICK START	16
2.1 BRIEF INTRODUCTION.....	16
2.2 INTRODUCTION	17
2.3 FRONT PANNEL INTRODUCTION.....	18
2.4 REAR PANEL DESCRIPTION	19
2.5 POWER-ON SELFTEST	19
CHAPTER3 PANEL FUNCTION INTRODUCTION.....	22
3.1 MAINFRAME OPERATION	22
3.1.1 Mainframe keyboard functions introduction.....	22
3.1.2 Menu list	24
3.1.3 Channel option.....	28
3.1.4 Save and recall.....	29
3.1.5 Configuration menu introduction	29
3.1.6 Module keyboard lock.....	29
3.2 MODULE OPERATION	29
3.2.1 Single channel module panel	29
3.2.2 Dual channel module panel	30
3.3 VFD INDICATOR FUNCTION DESCRIPTION.....	31
3.4 8-PIN CONTROL CONNECTOR.....	31
3.4.1 External trigger connections	32
3.4.2 External ON/OFF control connection	33
3.5 EXTENDED FRAME CONNECTIONS.....	33
3.6 CONTROLLING LINK	34
CHAPTER4 OPERATIONS INTRODUCTION.....	36
4.1 LOCAL/REMOTE OPERATION.....	36
4.2 PC CONTROL CONNECTION.....	36
4.3 OPERATING MODES.....	36
4.3.1 Constant current (CC) mode	37
4.3.2 Constant resistance (CR) mode.....	38
4.3.3 Constant voltage (CV) mode	38
4.3.4 Constant power (CW) mode	39
4.3.5 Compound Operation Mode	40
4.3.6 Operations.....	41
4.4 TRANSIENT OPERATION.....	42
4.4.1 Continuous	43
4.4.2 Pulsed	43
4.4.3 Toggled	43
4.4.4 A/B transient operations	44

4.5 LIST OPERATION	45
4.6 TRIGGERED OPERATION.....	48
4.6.1 Trigger function.....	48
4.6.2 Trigger source.....	48
4.7 SHORT OPERATION.....	48
4.8 INPUT ON/OFF OPERATION	49
4.9 SYNCHRONOUS LOAD	49
4.10 VON OPERATION	49
4.11 PROTECTION FUNCTIONS.....	51
4.11.1 Over voltage protection (OVP)	51
4.11.2 Over current protection (OCP)	51
4.11.3 Over power protection (OPP)	52
4.11.4 Over temperature protection (OTP)	52
4.11.5 Reverse voltage alarm (LRV)	52
4.12 SAVE AND RECALL OPERATION	52
4.13 AUTOMATIC TEST FUNCTION	53
4.14 CR-LED TEST FUNCTION	56
CHAPTER5 SPECIFICATIONS.....	59
5.1 MAIN TECHNICAL PARAMETERS	59
5.2 SUPPLEMENTARY CHARACTERISTICS.....	76
CHAPTER6 REMOTE OPERATION	77
6.1 RS232 INTERFACE	77
6.2 ETHER NET INTERFACE.....	79
6.3 GPIB INTERFACE(ONLY FOR IT8700(G) SERIES).....	79
6.4 USB INTERFACE	79
APPENDIX.....	80
SPECIFICATIONS OF RED AND BLACK TEST LINES	80

Chapter1 Inspection and Installation

This chapter mainly explains to the user how to do the inspection after receiving the package, and introduces the installation size and steps for the mainframe and modules.

1.1 Verifying the Shipment

Unpack the box and check the contents before operating the instrument. If wrong items have been delivered, if items are missing, or if there is a defect with the appearance of the items, contact the dealer from which you purchased the instrument immediately.

The package contents include:

Item	Qty	Model	Remarks
Electronic Load	x1	IT8700 series	The IT8700 series include: IT8722/IT8723/IT8731/IT8732/IT8733/ IT8722B/IT8732B/IT8733B/IT8722P/ IT8723P/IT8731P/IT8732P/IT8733P/IT 8722BP/IT8732BP/IT8733BP/IT8702/ IT8703/IT8701P/IT8702P/IT8703P
Power cord	x1	IT-E171/IT-E172 / IT-E173/IT-E174	User may select an appropriate power cord that matches the specifications of power socket used in the area. See the Section Connecting the Power Cord for details.
USB	x1	-	-
Ex-factory Test Report	x1	-	It is the test report of the instrument before delivery.



NOTE

Upon verification of the shipment, keep the package and relevant contents thereof in a safe place. When returning the instrument for warranty service or repair, the specified packing requirements shall be met.

1.2 Installation Size Introduction

The instrument should be installed at well-ventilated and rational-sized space. Please select appropriate space for installation based on the electronic load size.

IT8701P Mainframe size

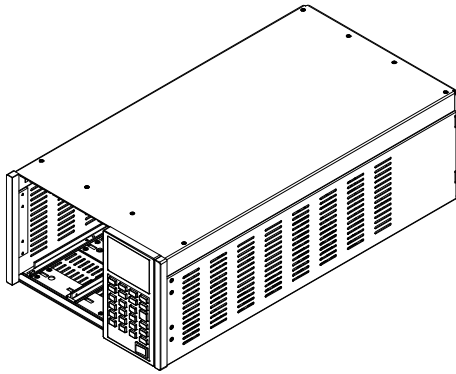

Detailed Dimension Drawing

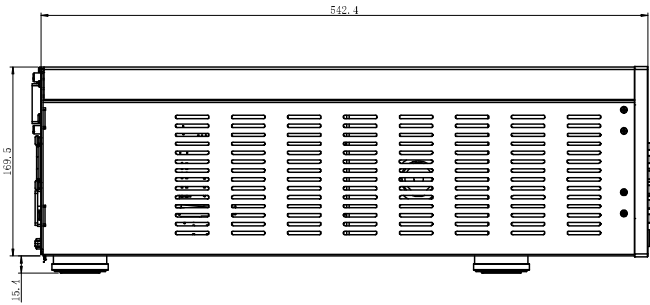
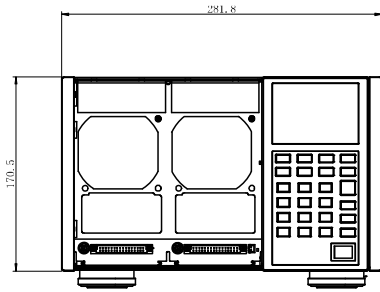

IT8702 Mainframe size

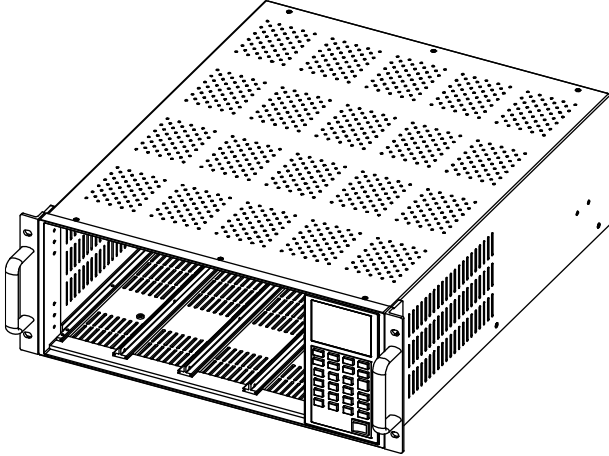

Detailed Dimension Drawing

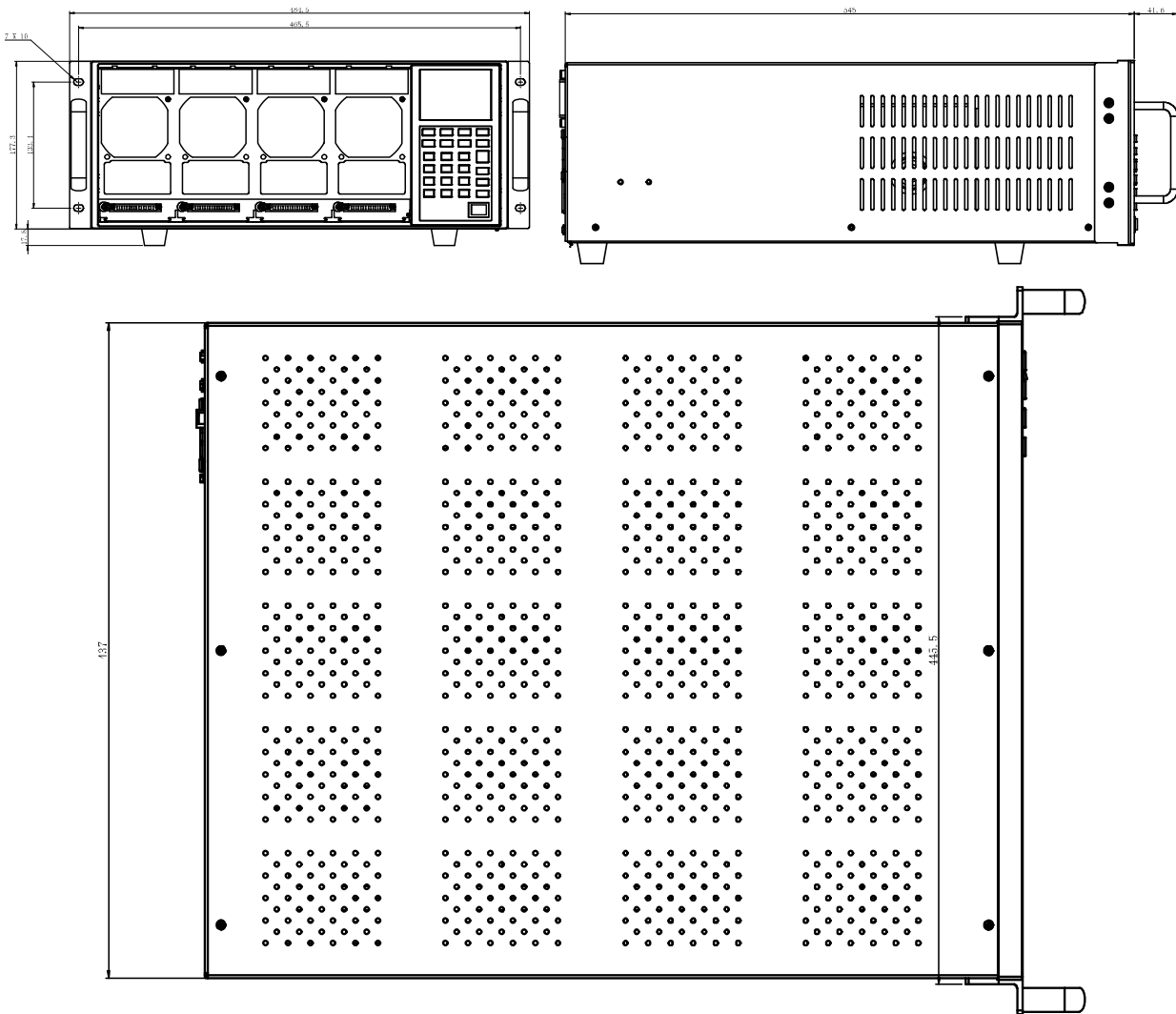

IT8703 Mainframe size

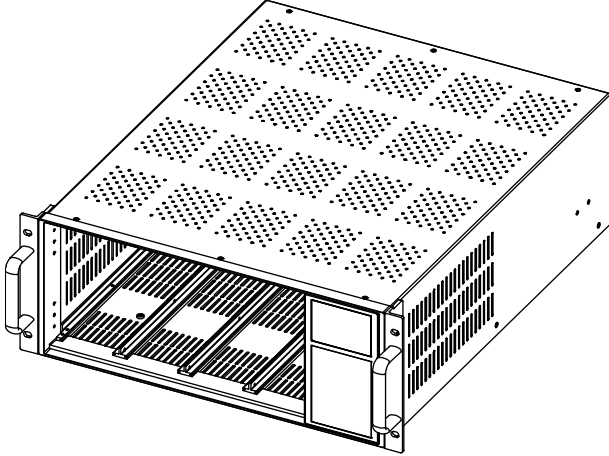

Detailed Dimension Drawing

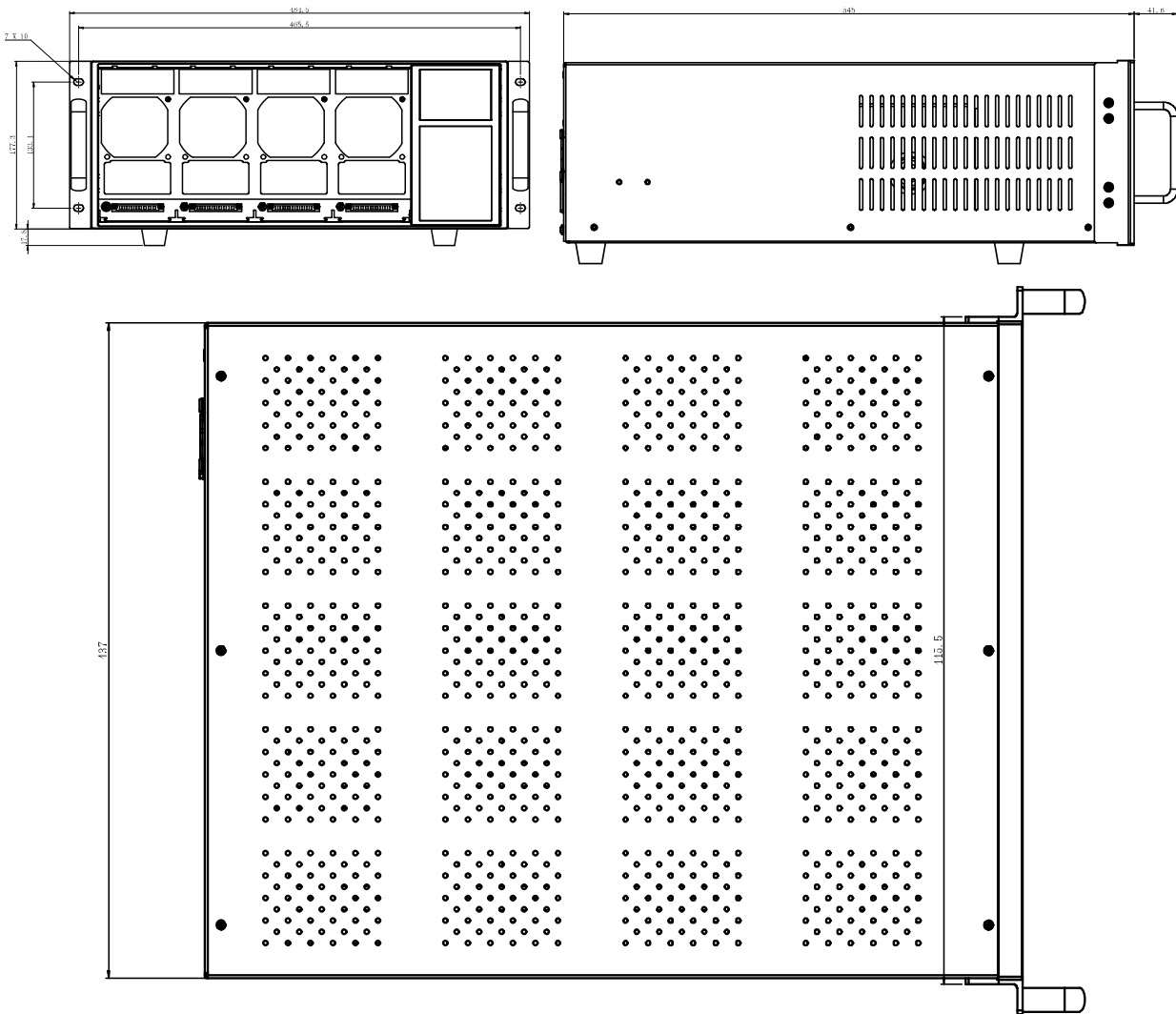

IT8702P Mainframe size

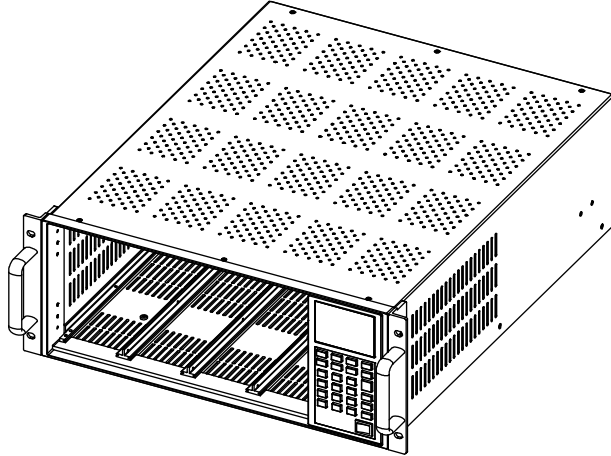

Detailed Dimension Drawing

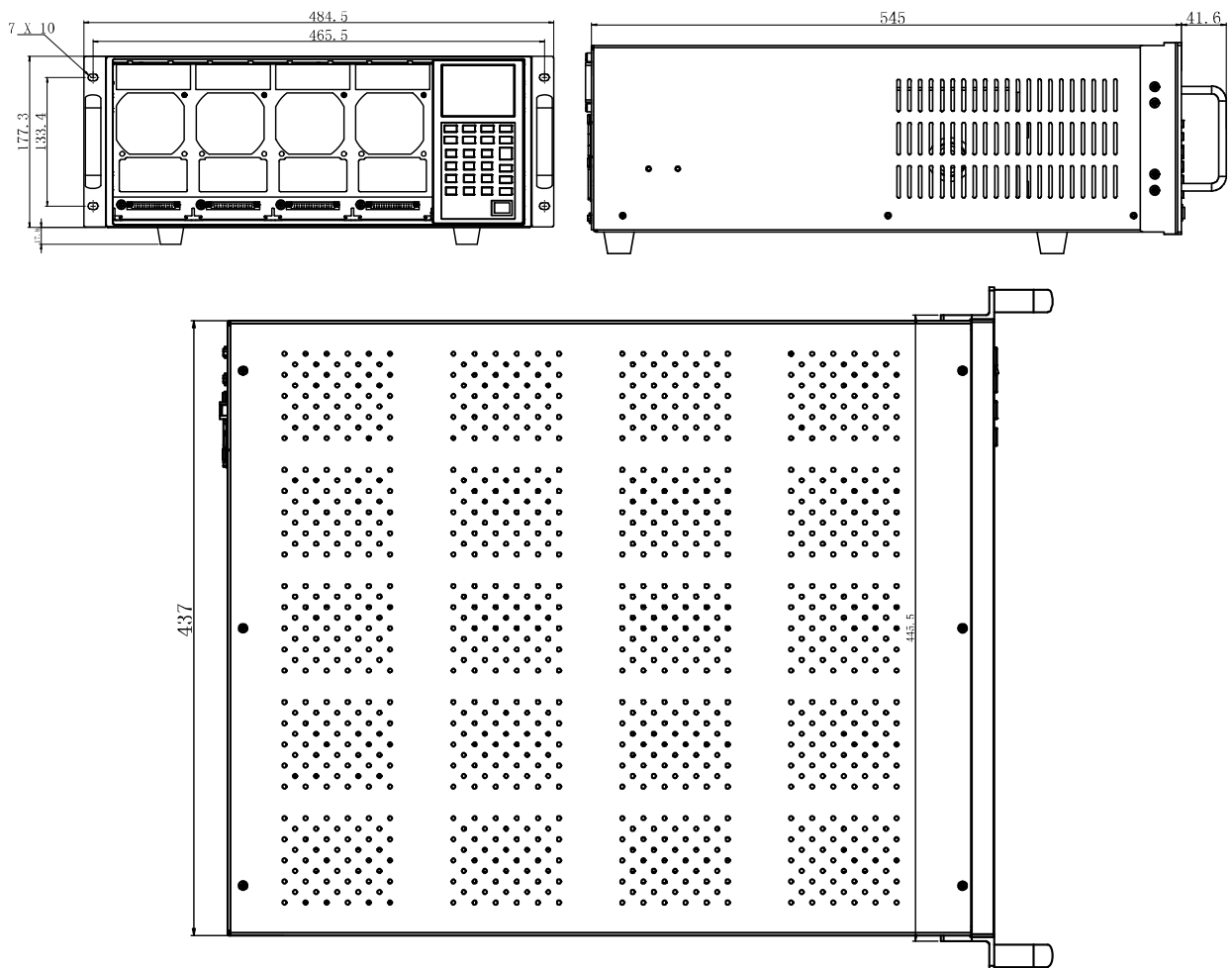

IT8722/IT8723/IT8722B Module

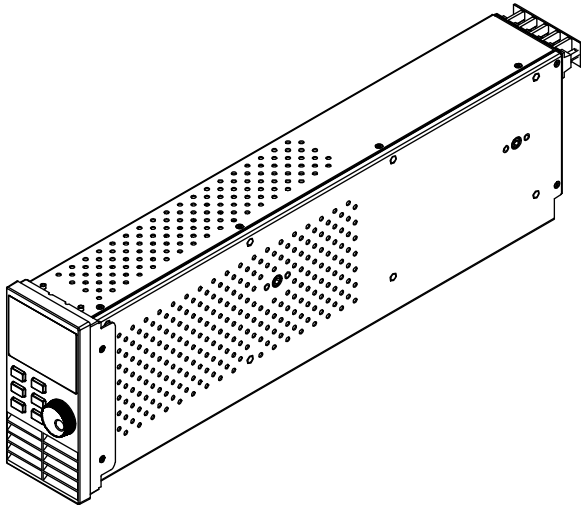

Detailed Dimension Drawing

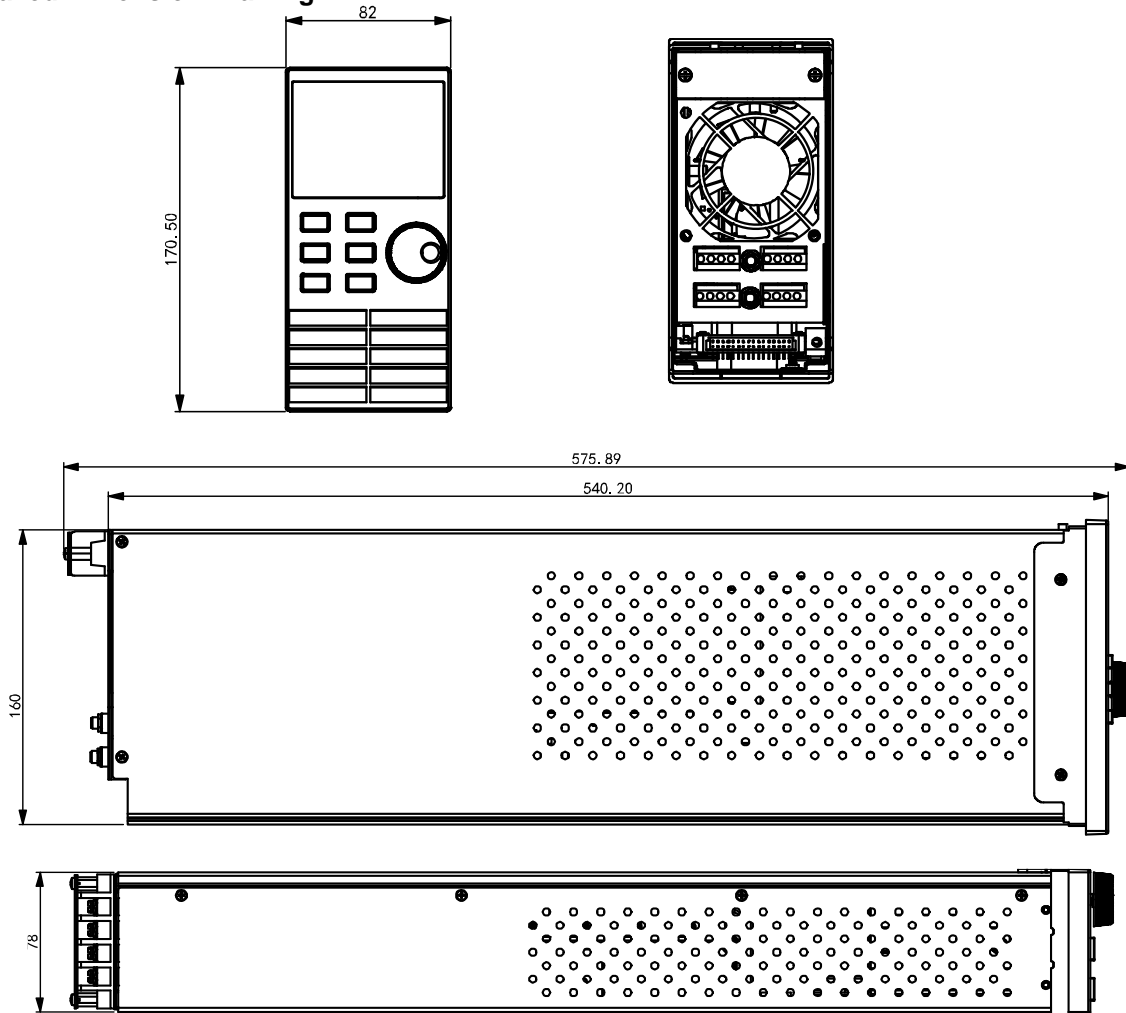

IT8731/IT8732/IT8733/IT8732B/IT8733B Module

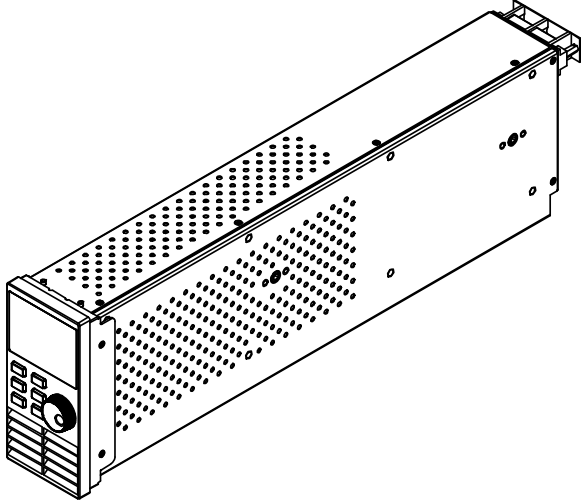

Detailed Dimension Drawing

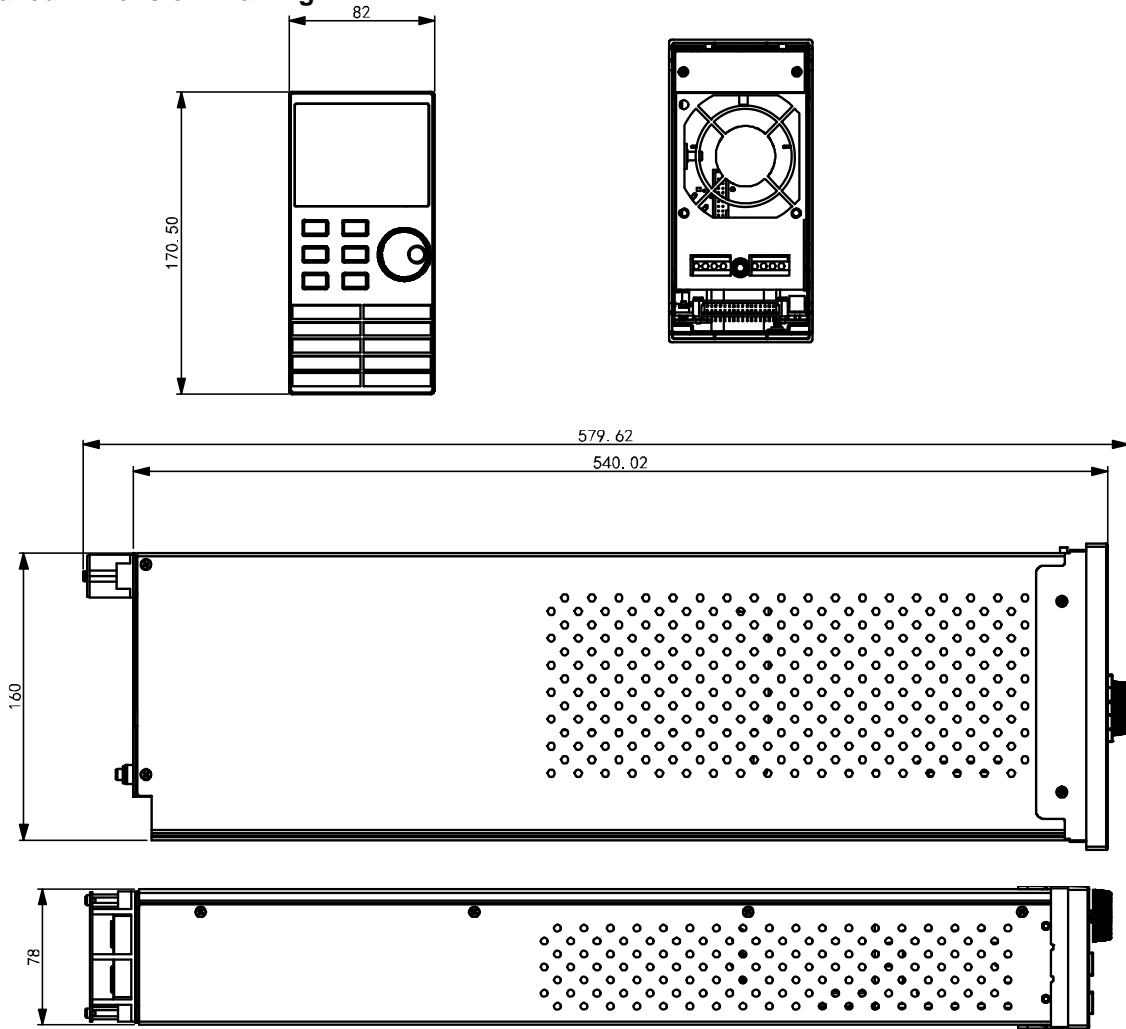

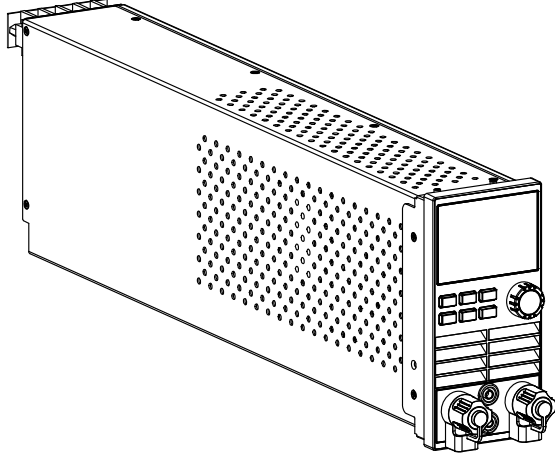
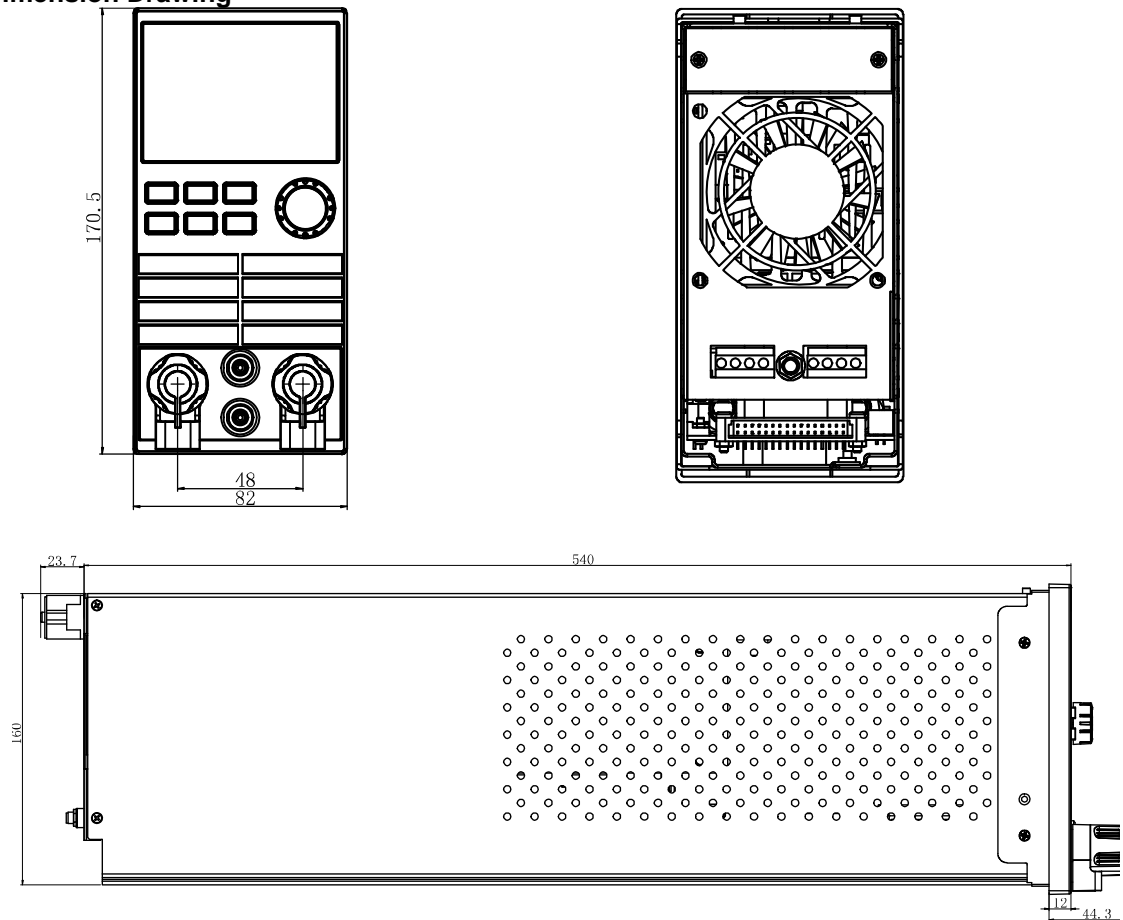
IT8722P/IT8723P/IT8731P/IT8732P/IT8733P/IT8722BP/IT8732BP/IT8733BP Module

Detailed Dimension Drawing

1.3 Module installation

Two load modules can be installed into IT8701P mainframe, and four load modules can be installed into IT8702/IT8702P mainframe. If the modules installed all have double channels, the load will have eight channels at maximum. Load modules can be installed at any sequence into the mainframe. IT8703/IT8703P extended frame can also contain four load modules. The installation steps of extended frame are the same as single mainframe, which just need screwdriver.

Installation steps:

1. Turn off the power switch and disconnect the 110V/220V power cord.

2. Take off any packing materials around the mainframe.
3. Push the module into the slot(as shown in figure 1-1).
4. Fix the module with a screwdriver, the position of the screw is in the upside and backside of the machine frame.
5. Install other modules one by one

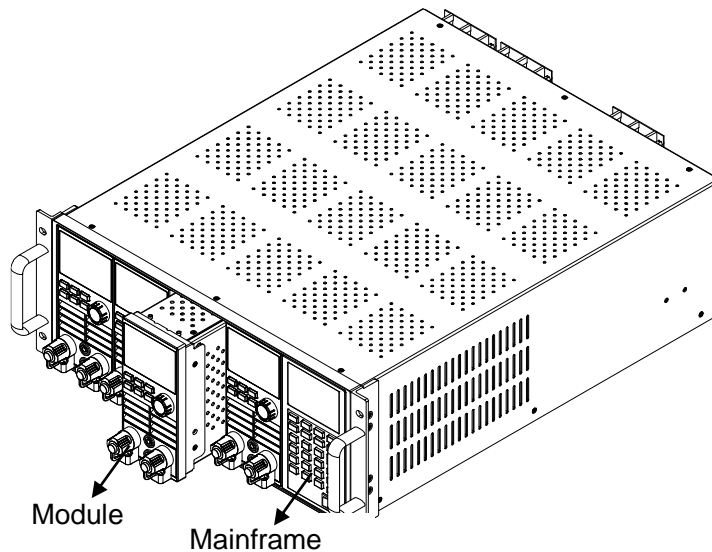

Figure 1-1 module installation

NOTE

Franklinism will damage the module. Please install the module according to standard electrostatic prevention operation style. Avoid touching the circuit board and connectors.

1.3.1 Channel number

To IT8700, the channel number for all modules is determined by the location of the modules in relation to right side of the mainframe. To IT8702 mainframe, the total channel number is 8. The 1st & 2nd channel are always next to the right mainframe while 7, 8 channels are always next to the left side. Load channel number is fixed even if the location isn't occupied. Load module could have one or two channels. The channel number of single channel model from right to left according to the slot position should be: 1th channel, 3th channel, 5th channel.... For module with dual channels, such as IT8722, the channel number should be: 1th and 2th channels, 3th and 4th channels, 5th and 6th channels... The figure below displays the rule of the module channel number. IT8701P/IT8702P mainframe and IT8703/IT8703P extended mainframe can be understood in the same way.

Channel number sequentially are: 8,7,6,5,4,3,2,1

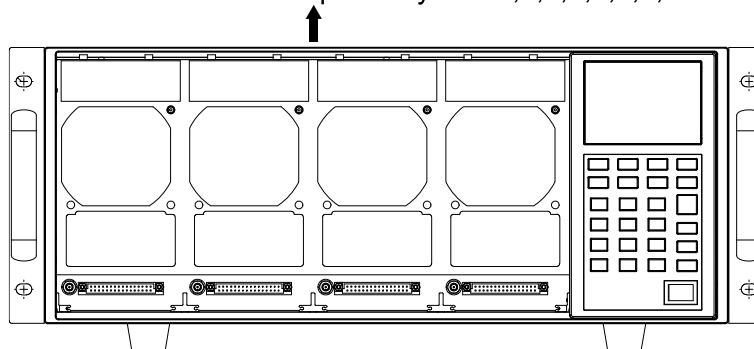

Fig 1-2 channel number distribution

For example: If IT8702 mainframe contains two single channel modules IT8731

and two double channels modules IT8722, channel number is automatically assigned to every channel at the sequence from right to left: 1,3,5,6,7,8. Now channel number 2,4 aren't occupied. IT8722 is double channels module. If the installation location of two IT8722 modules is close to the left of the mainframe, the channel number is 5,6,7,8 in sequence.

- Modules including single channel modules: IT8731, IT8732, IT8732B, IT8733, IT8733B and double channel modules: IT8722, IT8723, IT8722B can be installed into IT8702 mainframe or IT8703 extended frame according to your need.
- Modules including single channel modules: IT8731P, IT8732P, IT8732BP, IT8733P, IT8733BP and double channel modules: IT8722P, IT8723P, IT8722BP can be installed into IT8701P, IT8702P mainframe or IT8703P extended frame according to your need.

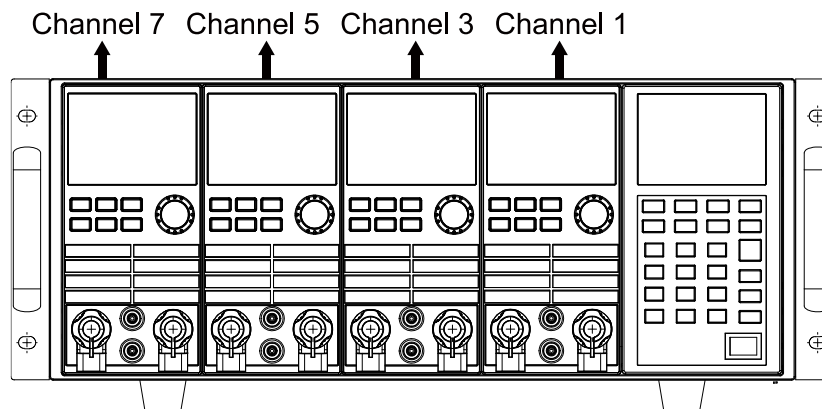

Fig1-3 channel number order while installing 4 single-channel unit

1.4 Mainframe installation

The operating temperature of IT8700 series electronic load is 0 to 40°C. A fan cools the electronic load by drawing air through the top and sides and exhausting it out by the rear side. The electronic load must be installed in a location that allows sufficient space at the sides and back of the unit for adequate air circulation. Minimum clearances for bench operation are 3cm on the top. If there are radiator fan in your cabinet, please avoid installing the load near the fan for cabinet fan because it will limit air circulation of load. If you are installing equipment on top of your electronic load in the cabinet, use a filler panel above the unit to ensure adequate for air circulation.

IT8702/IT8703/IT8702P/IT8703P has no accessory, each of them can be installed directly on the 19-inch support through screw holes of the left ear.



NOTE

Do not block the fan exhaust at the rear of the Load. When the load uses on the desk, make sure there enough space on the bottom of the equipment for air circulation.

1.5 Connecting the Power Cord

Connect the power cord after checking that the power switch of the instrument is turned OFF.

AC power input level

IT8700 series electronic load support 110V/220V AC input. Please pay attention to the AC level setup before provide AC power. (The AC line switch is located at the rear of the unit.)

- Option Opt.1: 220V \pm 10% 50Hz/60Hz
- Option Opt.2: 110V \pm 10% 50Hz/60Hz

Input voltage selection

The load can work under 110/220V \pm 10%AC input, as the label shown on the rear (refer to figure 1-4) . If the default value on the label doesn't match your region's, please switch the black key to choose input line voltage, and then insert power cord. Choose the right linear voltage as following.



NOTE

There's no need to change fuse when linear voltage changes. The fuse can protect the electronic load at any setting voltage specified.

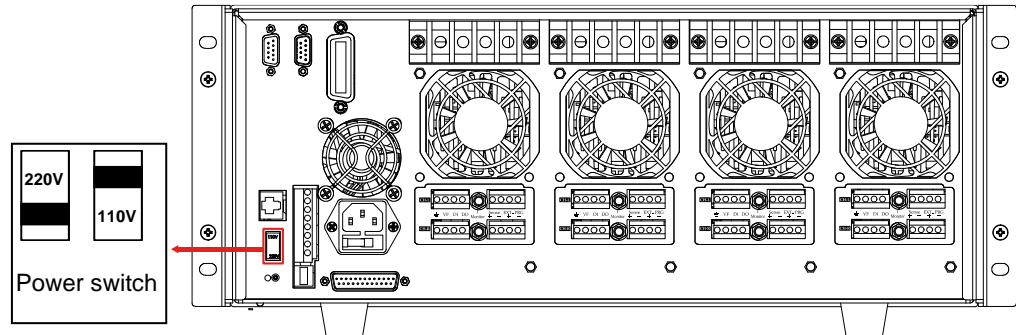
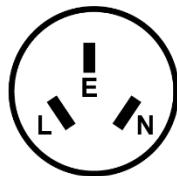

Figure 1-4 power switching keys

Types of power cord

Select from the following schedule of Power Cord Specifications an appropriate power cord that matches the voltage for the area in which you use the instrument. If the power cord included in the instrument you purchased does not match the voltage, contact the dealer or manufacturer for change.



China
IT-E171



United States &
Canada
IT-E172

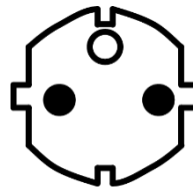

Europe
IT-E173

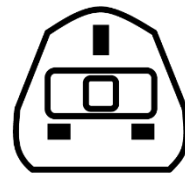

England
IT-E174

Figure 1-5 types of power cord

Connecting AC Input

Connect standard power cord to the power supply input terminal.

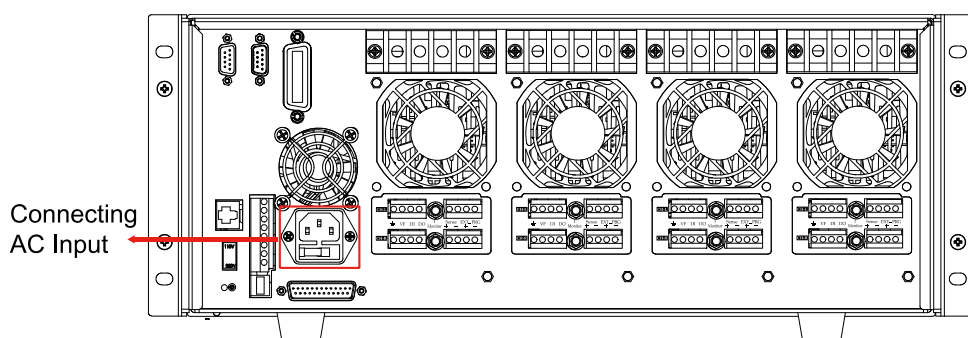

Figure 1-6 Connecting AC Input

1.6 Connecting the Device Under Test

The instrument supports two connection methods between electronic load and DUT: Local measurement and Remote sensing.

- Local measurement : The voltage sensed by the instrument is the voltage at the output terminal of the instrument.
- Remote sensing : The voltage sensed by the instrument is the voltage at the terminal of the remote object under test.

Connecting the DUT (Local Measurement)

The connection diagram and steps of local sensing are as follows:

- **Front panel terminal wiring**

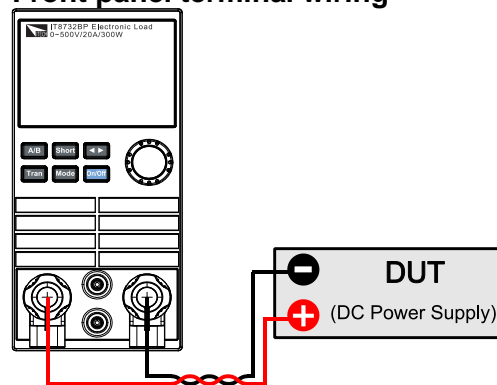

1. Before connecting the DUT, be sure that the Mainframe Power is in Off position.
2. Loosen the input terminals and connect the red and black test cables to the input terminals. Re-tighten the terminals.
3. Directly connect the other end of the red and black cables to the DUT.

Note

Only the IT8731P/IT8732P/IT8732BP/IT8733P/IT8733BP/IT8722P/IT8723P/IT8722BP modules support front panel terminal wiring.

- **Rear panel terminal wiring**

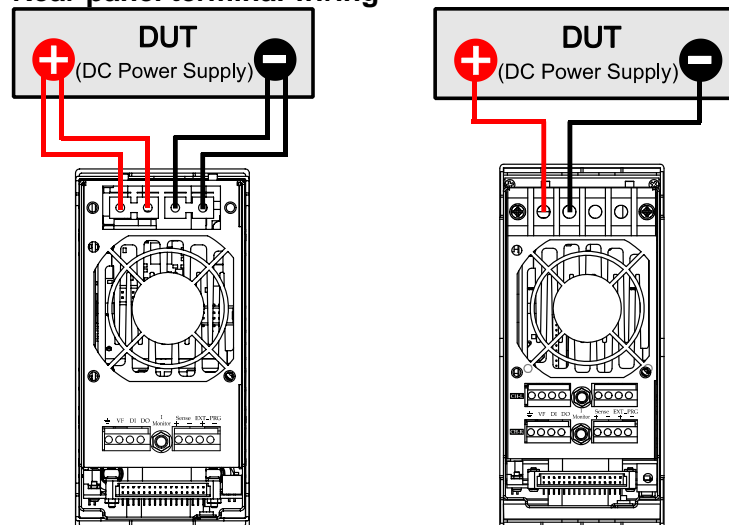

(Single channel modules)

(Double channel modules)

1. Before connecting the DUT, be sure that the Mainframe Power is in Off position.
2. Remove the cover of input terminal.
3. Loosen the screws of the input terminals and connect the red and black test cables to the input terminals. Re-tighten the screws.
4. Thread the red and black test cables through the input terminals cover of the instrument and install the cover.
5. Directly connect the other end of the red and black cables to the DUT.

Connecting the DUT (Remote Sensing)

When load is at CV、CV or CR mode, lead length are relatively long or load regulation is critical, or load consumes high-current, there will be voltage drop in the leads connected between load and measured object which affect the accuracy of measurement, then the sense connection can be applied. Fig 3-10 illustrates a typical connection between module and device for remote sense operation.

Remote Sensing: Sense+ and Sense- are the remote sensing inputs. By eliminating the effect of the inevitable voltage drop in the load leads, remote sensing provides greater accuracy by allowing the load to regulate directly at the source's output terminals. You should enable the remote sense function in the configure menu and then connect the remote sense lines. The front panel of the module shows "sense".

Take single channel module for example, there're two input connectors. One is load input measurement terminal; the other is Vsense measurement terminal.



Note

The electric potential on the positive terminal of Vsense connector must be higher than negative one.

The connection diagram and steps of remote sensing are as follows:

- **Front panel terminal wiring**

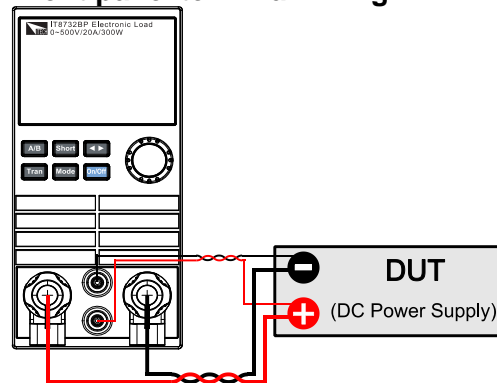

1. Before connecting the DUT, be sure that the Mainframe Power is in Off position.
2. Use armored twisted-pair cables to connect the remote sense terminals and the equipment under test.
3. Loosen the screws of the input terminals and connect the red and black test cables to the input terminals. Re-tighten the screws.
4. Connect the other end of the remote sense cables and the red and black cables to the DUT.



Note

Only the IT8731P/IT8732P/IT8732BP/IT8733P/IT8733BP/IT8722P/IT8723P/IT8722BP modules support front panel terminal wiring.

- **Rear panel terminal wiring**

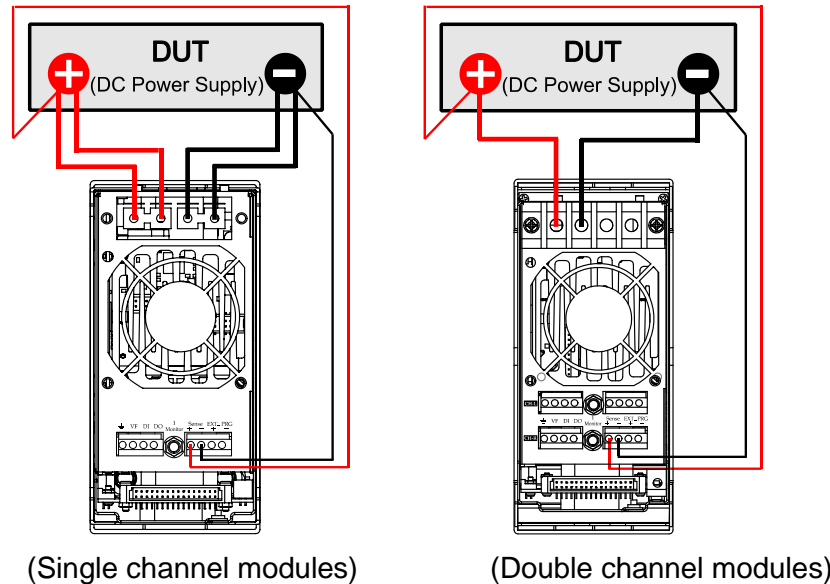

1. Before connecting the DUT, be sure that the Mainframe Power is in Off position.
2. Remove the cover of input terminal.
3. Loosen the screws of the input terminals and connect the red and black test cables to the input terminals. Re-tighten the screws.
4. Use armored twisted-pair cables to connect the remote sense terminals and the equipment under test.
5. Install the terminal cover, leave the other end of remote sense cables and the red and black cables outside.
6. Connect the other end of the remote sense cables and the red and black cables to the DUT.

 Note

For safety requirements, load wires between the electronic load and the object to be measured should be heavy enough not to overheat while carrying the short-circuit output current.

To prevent shock hazard, you must install the terminal cover correctly after wiring. Each terminal can carry up to 30A current, double-terminal connection is needed when the input current is more than 30A. (Double-terminal connection refers to the above picture.)

Parallel connections

Parallel connection can be applied between same model modules to increase current and power dissipation, but it can't be applied between different modules. Modules can be paralleled in CC/CR mode, but can't be in CV mode. Each module will dissipate the power it has been programmed for. For example, after being paralleled, two single channel modules (80V/40A/300W) can dissipate up to 80V/80A/600W. The following picture 1-7 illustrates the paralleled connection of two same models for increased power dissipation.

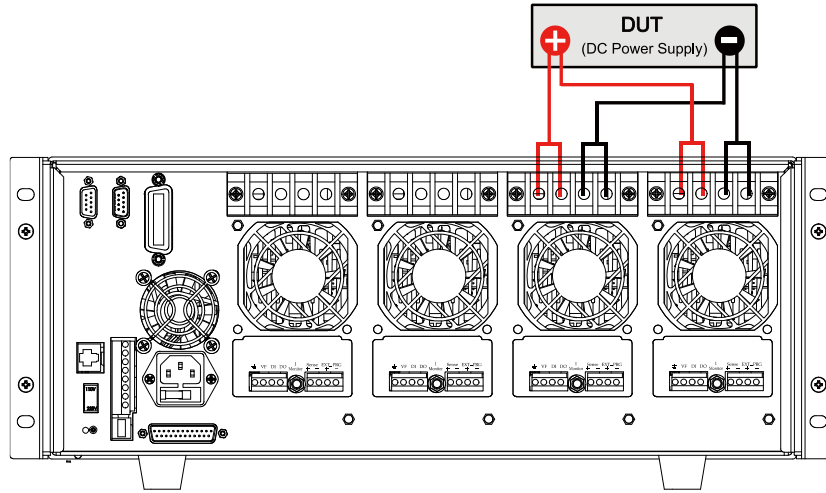

Fig 1-7 module parallel connection

Chapter2 Quick Start

This chapter introduces the front panel and the rear panel of the electronic load, make sure that you can quickly know the appearance, instruction and the key function before you operate the load, Help you make better use of this series of electronic load.

2.1 Brief Introduction

IT8700 series programmable DC electronic load adopts removable modules design, with single frame control 8 channels, and 16 channels with extended mainframe extension transient mode up to 25 kHz , which improves your test efficiency, with high resolution and accuracy. Users can freely choose in the 8 load modules according to the number of channels and power requirements, controlled by mainframe control panel, or controlled by IT9000-PV8700 software via built-in LAN / RS232 / USB interface.

IT8700, with adjustable slope, list function, automatic test and other functions, automatic test function can be set to work under CC / CV / CR / CW can be used in the application of R&D and production line. IT8700 has self-diagnosis and comprehensive OVP, OCP, OPP, OTP, etc., ensure the operator safety.

Product Features:

- Removable modules for easy system cofigurability
- Dual-channel module can display each channel information simultaneously
- Single frame up to max.8 channels, extended frame up to max.16 channels
- Dynamic power distribution function for dual channels
- Arbitrary selection of front/rear terminal *1
- Users can customize the left and right modules *1
- CV loop speed is adjustable to match different power supplies *1
- Multiple operating modes:
CC/CV/CR/CW/CV+CC/CR+CC/CW+CC/CV+CR(CR-LED) *2
- Measurement resolution: 0.1mV/0.01mA
- Measure short-circuit peak current value and peak voltage value
- Measurement speed for voltage, current up to 50kHz
- Adjustable current rising / falling slope
- Auto-test function, with automatic judgment whether the test result exceeds the set specification
- Simulate various waveforms with load under List mode
- Feature Up to 25kHz dynamic mode
- Automatic test function can automatically determine whether the test results exceed the set specifications Simultaneously perform multiple sets of electronic load modules
- OVP / OCP / OPP / OTP protection function
- Built-in Ether Net / USB / RS232 communication interface
- Support anti-reverse alarm function

*1 Only IT8700P have

*2 IT8700 only supports CC, CV, CR, CW operation mode

Model	Voltage	Current	Power	Channel
IT8731	80V	40A	200W	1
IT8732	80V	60A	400W	1
IT8733	80V	120A	600W	1
IT8732B	500V	20A	300W	1

IT8733B	500V	30A	500W	1
IT8731P	80V	40A	200W	1
IT8732P	80V	60A	400W	1
IT8733P	80V	120A	600W	1
IT8732BP	500V	20A	300W	1
IT8733BP	500V	30A	500W	1
IT8722	80V	20A	250W	2
	80V	20A	250W	
IT8723	80V	45A	300W	2
	80V	45A	300W	
IT8722B	500V	15A	250W	2
	500V	15A	250W	
IT8722P	80V	20A	250W	2
	80V	20A	250W	
IT8723P	80V	45A	300W	2
	80V	45A	300W	
IT8722BP	500V	15A	250W	2
	500V	15A	250W	

Matching frame

Mode	Description	Interface
IT8701P(G)	Two-load module main control unit	Including three interfaces
IT8702(G)	Four-load module main control unit	Including three interfaces
IT8702P(G)	Four-load module main control unit	Including three interfaces
IT8703	Four-load module expansion unit	-
IT8703P	Four-load module expansion unit	-



Note

- IT8700 series modules should be equipped with IT8702 mainframe.
- IT8700/IT8700P series modules should be equipped with IT8701P/IT8702P mainframe.
- Interface of mainframe : RS232, USB, Ether Net.
- *IT8700(G) is the model with built-in GPIB, the function is the same as standard model, please check with ITECH for availability.

2.2 Introduction

This user's manual introduces the specifications, installation, operation and programming of IT8700 series DC electronic loads. There're two parts in IT8700 DC electronic loads, mainframe/ extended frame and modules. The frames mentioned are IT8702/IT8701P/IT8702P mainframe and IT8703/IT8703P extended frame. The modules mentioned are divided into two kinds: single channel module (IT8731/IT8732/IT8732B/IT8733/IT8733B/IT8731P/IT8732P/IT8732BP/IT8733P/IT8733BP) and double channels module (IT8722/IT8723/IT8722B/IT8722P/IT8723P /IT8722BP). Each module should be installed into frame to work. The range of every module's specific voltage, current and power will be introduced in the Chapter 5: specifications in detail.

There are up to 4 channels in IT8701P mainframe. After extended with IT8703 or IT8703P mainframe, it can be up to 12 channels. The dimension of IT8702 is the same with IT8703. The difference is that IT8702/IT8701P/IT8702P are main control frame while IT8703/IT8703P is an extended unit. There are up to 8 channels in IT8702/IT8702P mainframe. After extended with IT8703 or IT8703P mainframe, it can be up to 16 channels. All panel operation and programming are also carried on the IT8702/IT8701P /IT8702P main panel.

One module could have one or two channels, each module will have its own channel number according to the slot position. In the case of IT8702 mainframe,

there are 4 slot locations and each slot location has 2 channels, thus there are 8 channels in total and the channel number ranges from right to left in sequence. if each slot has one channel, then the channel number from right to left should be:1th channel,3th channel,5th channel...For module with dual channels, the channel number should be:1th and 2th channels,3th and 4th channels,5th and 6th channels....IT8703 extended mainframe can be understood in the same way.

The technical parameters of each module such as voltage, current and power are different. Refer to Chapter5 Specifications for more details. The menu functions of module IT8731/IT8732/IT8732B/IT8733/IT8733B/IT8731P/IT8732P/IT8732BP/IT8733P/IT8733BP/IT8722/IT8723/IT8722B/IT8722P/IT8723P/IT8722BP are similar. The difference between the 16 load modules is: the input terminals of the IT8731/IT8732/IT8732B/IT8733/IT8733B/IT8722/IT8723/IT8722B are on the rear panel of the instrument; the input terminals of the IT8731P/IT8732P/IT8732BP/IT8733P/IT8733BP/IT8722P/IT8723P/IT8722BP are available on the front and rear panels of the instrument. The main functions are described as follows:

Module Features

- Working functions: constant current(CC),constant resistance(CR),constant voltage(CV),constant power(CW).
- Enable you to set the rising slope and falling slope of current in dynamic mode, dynamic functions has one mode: CC.
- Dynamic mode: up to 25KHZ.
- Voltage measuring resolution:0.1mV, Current measuring resolution 0.01mA(10 uA), measuring speed could reach 50KHZ.
- With remote sense function.
- Short-circuit function.
- Storage capacity:101 sets, used to save customer's setting parameters.
- List mode: enable you to edit a list file in CC mode. Number of list steps: 2-84, each step time: 0.00020~3600s.You can save seven list files.
- Auto test function, up to 10 test files or 100 test items.

2.3 Front Panel Introduction

There're two parts in front panel, which are main panel and module panel. Refer to figure 2-1. Main panel and module panel keys' function will be introduced below.

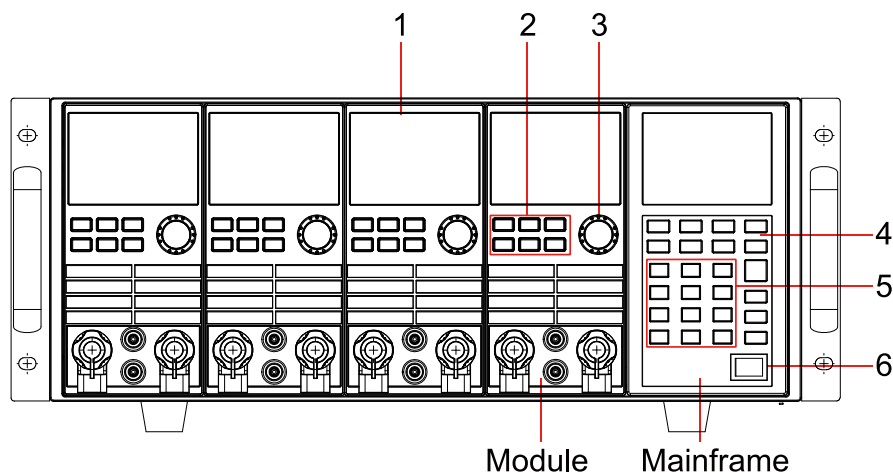

Figure 2-1 IT8700 front panel (take example of IT8702P)

1. VFD display
2. Module keyboard: <A/B>,<Short>,<Tran>,<Mode>,<On/Off> and direction keys.
3. Knob, change parameters
4. Mainframe function keyboard: control each channel's operating status. Control input status: On/Off. Specific buttons: <Chan>, <Save>, <Recall>, <Setup>, <On/Off>, <Trig>, <Start>, <Pause>, <Enter>, <Shift>, <▲>, <▼>.
5. Mainframe compound button(numeric keys) :1.set parameters 2.assembled menu function. detailed buttons:<1>,<2>,<3>,<4> plus function keys to enter the system menu,<5> plus function keys to enter the config menu, <6> plus function keys to enter program menu,<7> plus function keys to select local operation,<8> plus function keys to select lock function, <9>, <0>,<. >, <Esc>.
6. Power switch ON/OFF

2.4 Rear panel description

The part introduces the location of terminals and interfaces on the rear panel. Refer to figure 2-2 for more details.

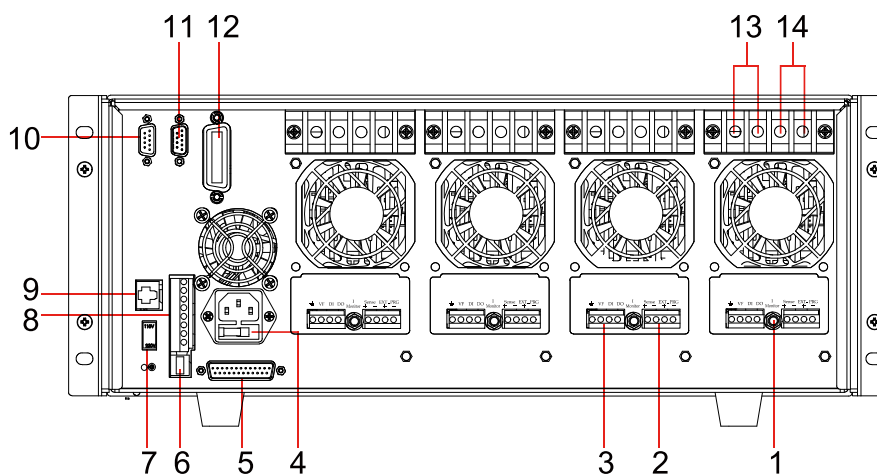

Figure 2-2 IT8700 rear panel (take example of IT8702)

1. Current monitoring terminal
2. Remote sense and external input control terminal
3. Digital I/O and VF output signal terminal
4. Power input socket (fuse contained)
5. Extended module interface
6. USB communication cable interface
7. Input voltage level switch (110V/220V)
8. Trigger input /output and ON/OFF input/output interface
9. Network interface
10. 9-pin COM port interface connector (RS232 communication cable interface)
11. 9-pin COM serial port connector (extended keyboard interface)
12. GPIB interface(Only for IT8700(G) series.)
13. Positive input terminal of module (if module is dual-channel, there is one positive terminal and one negative terminal)
14. Negative input terminal of module (if module is dual-channel, there is one positive terminal and one negative terminal)

2.5 Power-on Selftest

A successful test process indicates that the instrument meets the factory specifications and can be operated well. Before operation, please confirm that you have fully understood the safety instructions.

WARNING

- To avoid burning out, be sure to confirm that power voltage matches with supply voltage.
- Be sure to connect the main power socket to the power outlet of protective grounding. Do not use terminal board without protective grounding. Before operation, be sure that the power supply is well grounded.
- To avoid burning out, pay attention to marks of positive and negative polarities before wiring.

Selftest steps

The procedures of the self-test are as follows:

1. Correctly connect the power cord. Press [Power] key to start up. VFD display software version "BOIS Ver X.XX".
2. About 1S later ,system self-check "SYSTEM SELF TEST".
3. About 1S later, detect all modules installed. VFD displays the following information.

```
CH1/2/3/4/5/6/7/8  SCAN...
□7□5□3□1
```

4. About 1S later, display information of channel 1 or the most left channel. Use up and down key to select other channels. Such as: CH01 CV OFF
Vdc=0.0000V
Adc=0.0000A
Wdc= 0.00W

Exception handling

If the electronic load cannot start normally, please check and take measures by reference to steps below.

1. Check whether the power line is correctly connected and confirm whether the electronic load is powered.
Correct wiring of power line => 2
Incorrect wiring of power line => Re-connect the power line and check whether the exception is removed.
2. Check whether the power in On.[**Power**] key is under "I" On status.
Yes => 3
No => Please check the [**Power**] key to start power and check whether the exception is removed.
3. Check whether set power voltage of electronic load is larger than the power supply voltage. If set power voltage is 220 V and the supply voltage is 110V, the electronic load cannot start.
4. Check whether the fuse of electronic fuse is burned out.
If yes, change fuse. Detailed steps:
 - 1) Pull out power line and take out the fuse box at power line jack with a small screw driver. As shown below.

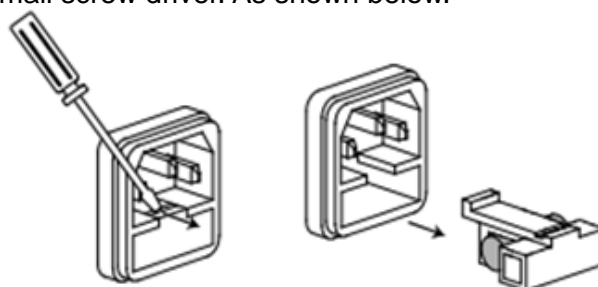

- 2) If the fuse is fused, please change fuse of same specification based on machine model. See the table below for matching information of fuse and machine model.

Model	Fuse specification (110VAC)	Fuse specification (220VAC)
IT8701P	T5A 250V	T2.5A 250V
IT8702	T5A 250V	T2.5A 250V
IT8702P	T5A 250V	T2.5A 250V
IT8703	T5A 250V	T2.5A 250V
IT8703P	T5A 250V	T2.5A 250V

- 3) After replacement, install the fuse box back to original position, as shown below.

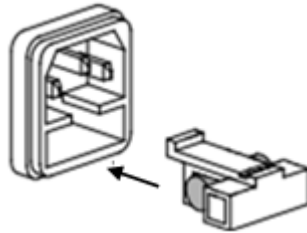

Chapter3 Panel function introduction

This chapter mainly introduces the functions and operations of front panel keys. It mainly describes the main frame's front panel keyboard operation, single /dual channel module keyboard operation and VFD display.

3.1 Mainframe operation

The front panel keys are effective only in the local mode. When the load is powered on, it works in local mode automatically, and then you can select channel number and set parameters such as voltage, current via the front panel keys. When the load is repowered on, the mainframe will scan all the installed modules once again, and can recall the parameters of the last power off.

3.1.1 Mainframe keyboard functions introduction

The keyboards of IT8702/IT8701P/IT8702P are the same. Take example of IT8702P, the keyboard introduction is as follows.

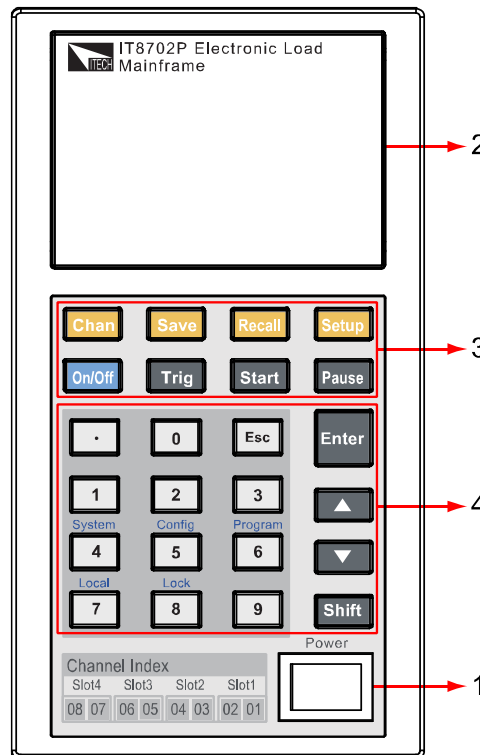

Fig 3-1 IT8702P mainframe front panel

1. Power switch: Turn the electronic load on and off. Connect the load with 110/220V voltage correctly. Press the POWER button, all the front panel will light up briefly while all the channels perform the power-on self-test.
2. VFD display: press the POWER key, the VFD screen lit, and shows the version number of this instrument's BOIS software, about 1S later, the system begin to self-test, after about 1S, check all the installed modules of the load, and display every channel's number, voltage and current measurements. The operation of setting and editing parameters of each channel referred below are on the mainframe front panel.
3. Function keys: The following are the detailed description about the functions and specific operations achievable of all the keys.

Key	Description
-----	-------------

Chan	Switch channel via Chan key: IT 8700 is a multi-load, one main frame controls all modules. Every module has its own channel number, select the channel to be edited on the main frame panel first, then start to edit, e.g. if you want to edit the 5th channel, press Chan key first, the VFD will show all the installed channels, press number key 5 directly to switch to 5 channel, now the channel can be edited.
Save	Save key is used to save data: After selecting the channel, edit its parameters, set work mode, voltage, current, Slope, the dynamic parameters and so on. Press Save key to save, up to 101 groups of parameters can be saved. All the parameters are saved in the Non-volatile memory, support power-off saving.
Recall	Recall key is used to recall data: Recall key can be used to fast recall the saved 101 groups parameters. All the used parameters only need to be edited and saved for one time and they will be always saved in the EPROM. You just need to recall them if necessary. It brings great convenience to the users, and save time.
Setup	Setup key is used to enter the specific channel's menu: press this key, you can achieve A/B transient mode, CC/CV/CR mode and so on, this menu has been introduced in detail in the menu list.
On/Off	On/Off key is used to control module's input state on/off: when you enabled the synchronization function in the menu of a channel, the key can correspondingly control the on/off state of the channel.
Trig	Trig key is used to trigger: when you edit the auto test file or the transient output, you should select the triggering source, this load have 5 kinds triggering mode, panel triggering is only one of them. It will be introduced in detail in the front panel triggering operation chapter.
Start	Start key is used to start automatic test: after recalling the edited automatic test file, press up and down to select Start , press Start key to start automatic test.
Pause	Pause key is used to pause: only press Pause key to pause when running a automatic test, at this time the VFD will display pausing at a step, press Pause key once again to test the file continuously.

4. Comprehensive key+ **0** ~ **9** number keys: **0** ~ **9** are number input keys; **Shift** + **4** / **5** / **6** key will respectively enter 3 menu, it has been introduced in detail in the menu list; if the load is in remote sense mode, press **Shift** + **7** key can switch to local mode; **Shift** + **8** key can lock module's panel keyboard and knob, repress them can unlock it; **Esc** exit key, can be used to exit any working state; **.** key means a point; **▲** key is used to move up, select the menu; **▼** key is used to move down, select the menu; **Enter** key is used to confirm; **Shift** key is a comprehensive key.

3.1.2 Menu list

Different modules of IT8700 series electronic loads have different setting and configuration menu according to different working modes.

Press **Setup** key to enter menu setting, view the menu in VFD and use **▲** and **▼** to scroll through the completely menu list as following. Press **Enter** key to enter the selected menu function, use **▲** and **▼** to scroll through the VFD screen, press **Enter** key to enter the under submenu, press **Esc** back to the previous menu selection page.

Setting menu

Press **Setup** key to enter menu setting.

- Setup menu list of IT8732B/IT8733/IT8733B/IT8731/IT8732/IT8722/IT8723/IT8722B:

Setup		
MODE	Select working mode	
	Const Current	Load works in CC mode
	Const Voltage	Load works in CV mode
	Const Resistance	Load works in CR mode
	Const Power	Load works in CW mode
CC/CV RANGE	Switch the range	
	High Range	
	Low Range	
I / V / R / W SET	Set the working current/voltage/resistance value	
Vmax/Amx	Setup the maximum voltage value/maximum current value	
Vmin/Amin	Setup the minimum voltage value/minimum current value	
Vd=0.000V	Set the break-over voltage value(Only for CR-LED mode)	
j=2.500A/uS	Set the up slope (only CC mode available)	
j=2.500A/uS	Set the down slope(only CC mode available)	
TRAN A=0.00A	Setup level A value	
Ta=0.0005S	Setup level A width	
TRAN B=0.00A	Setup level B value	
Tb=0.0005S	Setup level B width	
T MODE	Setup the transient mode	
	Continuous	Continuous mode
	Pulse	Pulse mode
	Toggle	Toggle mode

- Setup menu list of IT8732BP/IT8733P/IT8733BP/IT8731P/IT8732P/IT8722P/IT8723P/IT8722BP:

Setup		
MODE	Select working mode	
	Const Current	Load works in CC mode
	Const Voltage	Load works in CV mode
	Const Resistance	Load works in CR mode
	Const Power	Load works in CW mode
CC/CV RANGE	Switch the range	
	High Range	
	Low Range	
I / V / R / Pset	Set the working current/voltage/resistance value	
Vmax/Amx	Setup the maximum voltage value/maximum current value	
Vmin/Amin	Setup the minimum voltage value/minimum current value	

Alim	Set limited current value under CV/CR/CW mode.	
Vd=0.000V	Set the break-over voltage value(Only for CR-LED mode)	
CV Rate	Set CV loop speed. (Only for CV mode)	
i=2.500A/uS	Set the up slope (only CC mode available)	
i=2.500A/uS	Set the down slope(only CC mode available)	
TRAN a=0.00A	Setup level A value	
Ta=0.0005S	Setup level A width	
TRAN b=0.00A	Setup level B value	
Tb=0.0005S	Setup level B width	
Tmode	Setup the transient mode	
	Continuous	Continuous mode
	Pulse	Pulse mode
	Toggle	Toggle mode

Configuration menu

Press **Shift** + **5** key to enter the channel configuration menu

- Configure menu list of IT8732B/IT8733/IT8733B/IT8731/IT8732/IT8722/IT8723/IT8722B module:

MENU		
SYNC ON SET	Setup Synchronization ON / OFF function	
	ON <DEFAULT>	Turn on synchronization function
	OFF	Turn off synchronization function
VON		
	VON POINT	Set the load's von point
	VON LATCH	Von point latch state, ON /OFF
	EXIT	
Measure Rate	Measure rate set(2 ²⁻¹⁶)	
V AUTORAGE	Auto switching voltage range	
	ON<DEFAULT>	Enable this function
	OFF	Disable this function
PROTECT	Load protecting function	
	MAX POWER SET	Setup hardware power protecting
	ALIMIT STATE	Setup software current protecting state
	ON	Put on
	OFF <DEFAULT>	Put off
	ALIMIT POINT	Setup software current protecting value
	ALIMIT DELAY	Setup software current protecting delay
	PLIMIT POINT	Setup software power protecting value
	PLIMIT DELAY	Setup software power protecting delay
	ON TIMER STATE	Setup Load ON timer state
	ON TIMER SET	Setup Load ON timer time
	EXIT	
LIST		
	FUNCTION MODE	Select Mode
	FIXED	Choose fixed operation mode
	LIST	Choose list operation mode
	RECALL LIST	Recall list operation file
	EDIT LIST	Edit list operation file
	HIGH RANGE	In CC mode , Edit high range of list
	LOW RANGE	In CV mode , Edit low range of list
	EXIT	
CR-LED	Simulate the LED light to test LED power drive (in CR mode)	
	ON	Enable the function (in CR mode, press "setup" to set

		Vd level)
	OFF	Disable this function
EXT. CTR 1 SET	External analog control function	
	ON	Turn on external analog control function
	OFF (DEFAULT)	Turn off external analog control function
REM SENSE SET	Remote measuring	
	ON	Enable remote sense function
	OFF<DEFAULT>	Disable remote sense function
ABOUT	Module production information	
	IT87XX	Channel production model
	VER: X.XX	Channel software version
	SN: XXXXXXXXXXXXXX	Channel production serial number
EXIT		

- Configure menu list of IT8732BP/IT8733P/IT8733BP/IT8731P/IT8732P/IT8722P/IT8723P/IT8722 BP module:

MENU		
Sync On Set	Setup Synchronization On / Off function	
	On (Default)	Turn on synchronization function
	Off	Turn off synchronization function
Von		
	Von Point	Set the load's von point
	Von Latch	Von point latch state, On / Off
	Exit	
Measure Rate	Filter the input voltage of the instrument to reduce interference.	
	Slow	The filtering speed is low speed.
	Med (Default)	The filtering speed is medium speed.
	Fast	The filtering speed is fast speed.
V AutoRange	Auto switching voltage range	
	On (Default)	Enable this function
	Off	Disable this function
PROTECT	Load protecting function	
	Max Power Set	Setup hardware power protecting
	Alimit State	Setup software current protecting state
		On Put on
		Off (Default) Put off
	Alimit Point	Setup software current protecting value
	Alimit Delay	Setup software current protecting delay
	Plimit Point	Setup software power protecting value
	Plimit Delay	Setup software power protecting delay
	On Timer State	Setup Load ON timer state
	On Timer Set	Setup Load ON timer time
	Exit	
LIST		
	Function Mode	Select Mode
		Fixed Choose fixed operation mode
		List Choose list operation mode
	Recall List	Recall list operation file
	Edit List	Edit list operation file
	Exit	
CR-LED	Simulate the LED light to test LED power drive (in CR mode)	
	On	Enable the function (in CR mode, press "setup" to set Vd

		level)
	Off <Default>	Disable this function
Ext. Ctr1 Set	External analog control function	
	On	Turn on external analog control function
	Off <Default>	Turn off external analog control function
Rem Sense Set	Remote measuring	
	On	Enable remote sense function
	Off <Default>	Disable remote sense function
About	Module production information	
	IT87XX	Channel production model
	VER: X.XX	Channel software version
	SN: XXXXXXXXXXXXXX	Channel production serial number
EXIT		

System menu

Press **Shift** + **4** key to enter system menu function

MENU		
Initialize		
	Initialize Default Set	Resume all configuration to default
Power On Set		
	RST <Default>	Set the load's input state to be the default state when power on
	SAV0	Set the load's input state to be that of SAVE 0 set when power on
Buzzer Set	Setup the buzzer state	
	ON <Default>	enable the function
	OFF	disable the function
Load On Knob	Module knob mode setting	
	Updated <Default>	Real-time Update
	OLD	No update (when ON/OFF resume the original value)
Trigger Sour.	Setup the trigger mode	
	MANUAL <DEF>	Manual trigger
	EXTERNAL	External signal trigger mode
	HOLD	Trig: IMM available
	BUS	GPIB bus trigger mode
	TIMER	Timer trigger
Trigger Timer	Trigger time setting	
	TRIGGER TIMER SET	Setup the time of the trigger timer
Communication	Select the port to communicate with a computer	
	RS232 <DEFAULT>	
	USB TMC-USB488	
	GPIB	
	ETHERNET	
RS232 SET		
	Baudrate Set	Setup the communication baud rate
		4800 <Default>
		9600
		19200

		38400
		57600
		115200
	Parity Set	Setup the communication parity
		None <Default>
		Odd
		Even
	HANDSHAKE SET	Handshake protocol
		None <Default>
		CTS/RTS
		XON/XOFF
	EXIT	
GPIB ADDRESS	GPIB address setting	
	GPIB ADDRESS SET	Setup communication address
Ethernet Set	Ethernet setting	
	GATEWAY SET	Gateway setting
	IP SET	IP setting
	MASK SET	Mask setting
	PORT SET	SOCKET port setting
	EXIT	
Expand Module		
	On	Enable this function
	Off <Default>	Disable this function
Language Set	Production protocol	
	SCPI <DEFAULT>	SCPI protocol
	EXTEND TABLE	Expand SCPI protocol, compatible with others
About	Main module production information	
	IT8700	Main frame production model number
	VER: X.XX	Main frame software version
	SN: XXXXXXXXXXXXXXX	Main frame production serial number
EXIT		

Automatic test menu

Press **Shift** + **6** key to enter the menu function.

PROGRAM	
RUN PROGRAM	Run the testing file
RECALL PROG	Recall the testing file
EDIT PROGRAM	Edit the testing file
EXIT	

3.1.3 Channel option

IT8702/IT8701P/IT8702P can switch the channel. There're 3 ways to switch channel:

- **Chan** +number key to switch channel.
- Press **Chan** / **▲** **▼** key to switch.
- When in SETUP menu, you can directly press the number keys to switch.

3.1.4 Save and recall

First select the channel to be edited at the main frame front panel, after having edited, press **Save** key to save, press 1 numeric key to save to the first group in location 1. Press **Recall** key to recall, and then press key 1 to recall the file saved earlier

3.1.5 Configuration menu introduction

Details on each channel menu function. For example, if you don't want the 3 channel to work with other channels synchronously, you can switch to channel 3 on the main frame, press **Shift** + **5** key to enter module configuration menu, VFD views <SYNC ON SET> , press **Enter** key to enter, setup OFF state. In the same method to setup other functions in the configuration menu.

3.1.6 Module keyboard lock

Press **Shift** + **8** key to lock the Short、Tran、Mode、On/Off operation keyboard and knobs of the current channel panel, press **Shift** + **8** key again to unlock.

3.2 Module operation

IT8700 modules have 2 kinds input: one is single input module and the other is dual-input module. There are 6 keys and a knob on the front panel for each module. Below are the detail introduction of module panel keys and functions.

3.2.1 Single channel module panel

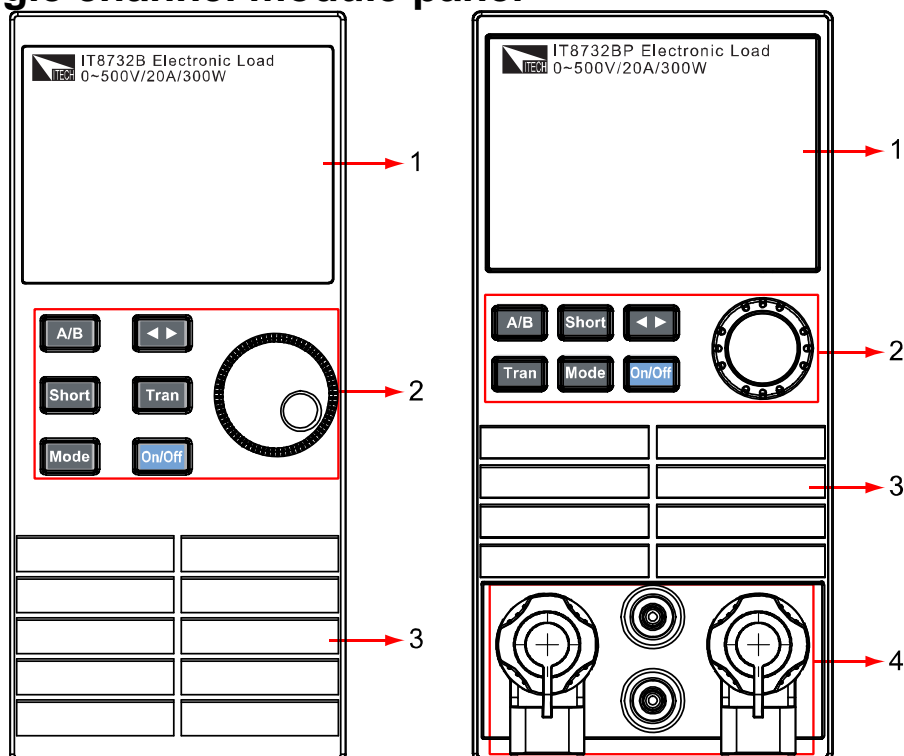











Fig 3-2 single channel module panel

1. **Module's panel view:** high-brightness VFD display show module 's working mode.
2. Module's panel keyboard:

Button	Description
	Switch A/B transient preset value
	Realize short testing, allows the load to simulate a short-circuit at the input
	Switch the work mode
	Move the cursor position. Press  key to move the cursor to the position you want to edit, and then use the rotary knob to adjust value.
	Select the transient mode, press  key first to enable transient mode before running A/B transient operation, and then send the triggering signal to run program.
	Control module's input state: on/off
	Rotary knob, used to change the setting parameter values

3. Module's air inlet
4. Input terminal of module

3.2.2 Dual channel module panel

Dual channel module means a module have two channels. Each channel is isolated with the other. Setting of the module keyboard can control two channels. The left channel is channel L, the right channel is channel R.

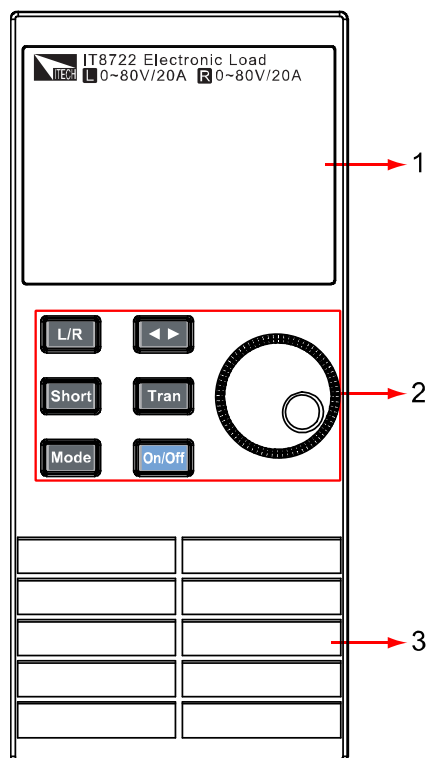











Fig 3-3 dual-channel module front panel

1. **Module's panel view:** highlight VFD which display the working state, upper display voltage and current information for channel L; lower displays information for channel R.
2. Module's panel keyboard:

Button	Description

	Switch the left/right channels.
	Realize short testing, allows the load to simulate a short-circuit at the input
	Switch work mode
	Move the cursor position. Press  key to move the cursor to the position you want to edit, and then use the rotary knob to adjust value.
	Select the transient mode, press  key first to enable transient mode before running A/B transient program, and then send trigger signal to run the program
	Control module's input state: on/off
	Rotary knob, used to change the setting parameter values

3. Module's air inlet
4. Input terminal of module

3.3 VFD indicator function description

The detailed introduction of VFD's all indicator functions are as bellow:

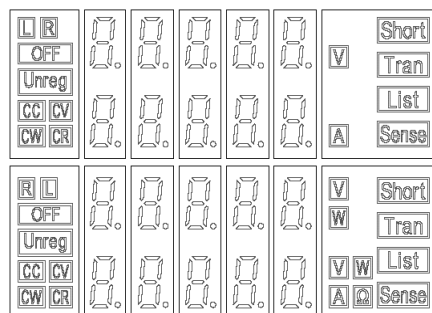

3-4 load module VFD panel

1. L/R is the indicator of dual channel module's left/right channel, if you want to edit left/right channel parameters, first select the channel, L is the left channel; R is the right channel. Single channel module will always display R.
2. OFF indicates that the module input is off, when enable the module input, OFF will turn off.
3. CC, CV, CR and CW are module's 4 work modes.
4. VFD display screen has 4 lines of number show, the first line shows the current actual voltage value, the second line shows the actual current value, the third line shows the actual circuit's power value, the fourth line shows the setup value, users can set A/V/ Ω /W value.
5. Short is lit up, when the module enables short-circuit function.
6. TRAN is lit up, when the module enables transient mode.
7. LIST is lit up, when select the LIST mode at the configuration.
8. SENSE is enabled in remote meter function.

3.4 8-pin control connector

IT8700 electronic load 8-pin connector on rear panel (figure 3-5):

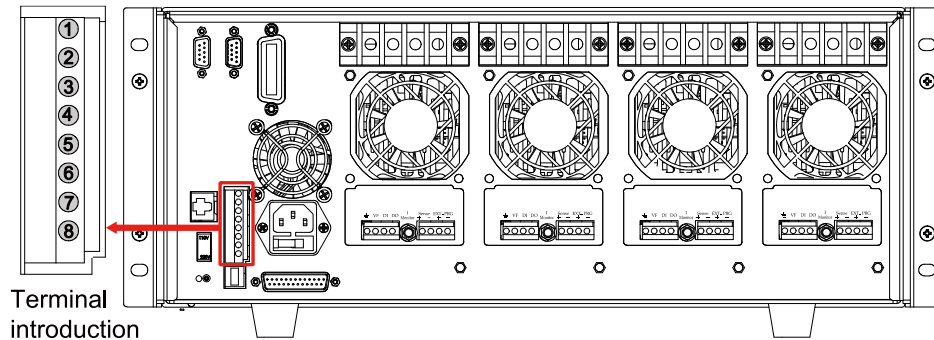

Figure 3-5 IT8700 rear panel 8-pin control connector (take example of IT8702)

No.	Pin	Description
1	Trigger IN	trigger signal input
2	Trigger OUT	trigger signal output
3	On/Off Control	synchronization ON/OFF control signal input
4	On/Off Status	synchronization ON/OFF signal output
5	NC	-
6	NC	-
7	GND	Ground
8	GND	Ground

3.4.1 External trigger connections

There're five kinds of trigger mode:

- front panel TRIG trigger mode
- rear panel trigger mode
- BUS trigger mode
- Timer trigger mode
- trigger HOLD mode

Front panel TRIG trigger mode

When select front panel trigger mode, first set the trigger source as MANUAL, press **Trig** to start panel trigger mode.

Rear panel trigger mode

When select rear panel trigger mode, first set the trigger source as EXTERNAL, trigger signal input from the 1st pin of 8-pin terminal on the rear panel.

When select external trigger mode, the 1st and 8th send out trigger signal (low pulse is effective), e.g. refer to the below connection figure:

The figure just show one way to produce trigger signal. When press the button, it produce a trigger to change setting value (voltage, current, resistance, etc.), e.g. switch in transient mode, or create pulse in dynamic pulse mode. At the same time, it can output trigger signal in pin 2.

BUS trigger mode

When select bus trigger mode, first set the trigger source as BUS, connect the electronic load by GPIB or USB communication interface, then if get the *TRG command, the load will produce a trigger signal.

Timer trigger mode

When select timer trigger mode, first set the trigger source as TIMER, set the TIGGER TIMER's time, the load will produce a signal from time to time.

Trigger HOLD mode

When select hold trigger mode, first set trigger source as HOLD, the load will produce signal when get the TREG: IMM command.



NOTE

Pin 2 will output corresponding trigger signal whatever trigger mode you choose.

3.4.2 External ON/OFF control connection

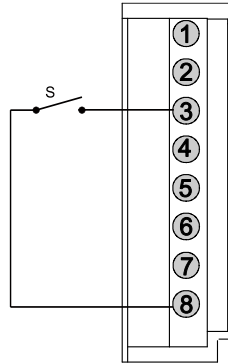

Figure 3-6

ON/OFF IN is used to control the multi-channel to take load or unload synchronously. When ON/OFF IN pin receives a low pulse, ON/OFF state of load will reverse. If Sync On Set of a specific channel is set ON, then you can use figure 3-6 connection to control its ON/OFF state.

ON/OFF OUT indicates ON/OFF state of multi channels electronic load. If Sync On Set of any specific channel is set on, and the channel's input state is on, the pin 4 output low level, otherwise it output high level.

3.5 Extended frame connections

The following section introduces extended function of IT8702 mainframe. Take example of IT8702, the introduction is as follows.

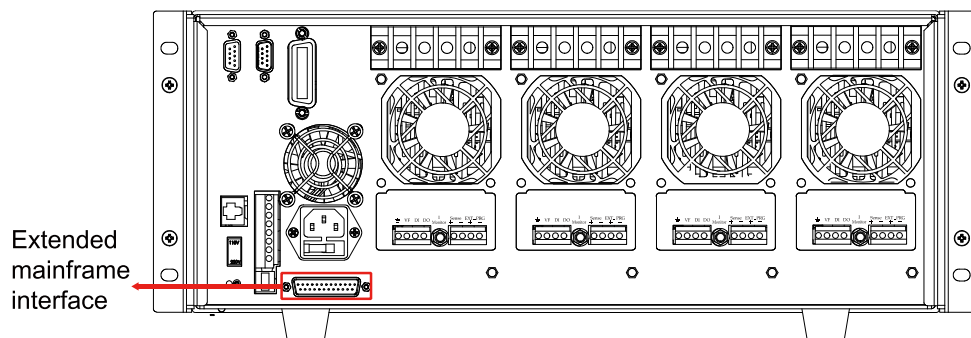

Figure 3-7 Expand interface

This interface can be used to connect extended frame. IT8702 can take up to 16 channels with IT8703.

IT8701P can take up to 12 channels with extended frame and IT8702P can take up to 16 channels with IT8703P.

Procedure:

Take example of IT8702, use expanded cable to connect mainframe and expand interface of extended frame. Enable expand function in the menu of IT8702 mainframe by pressing **Shift** + **4**, select "Expand module", choose ON.

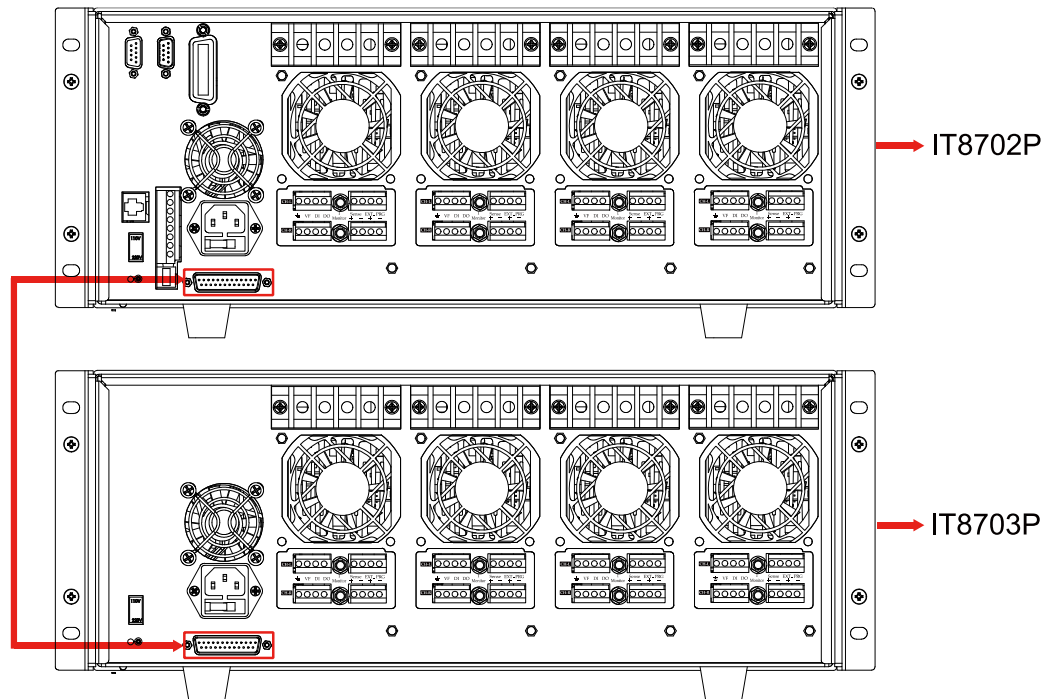

Figure 3-8 Expand connections

3.6 Controlling link

There is an 8-pin connector on every module's rear panel. The following will introduce in detail the 8 pins' specific functions.

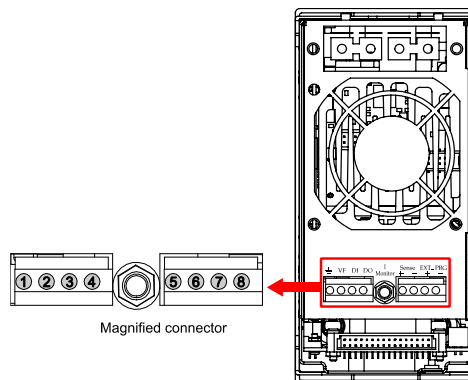

Fig 3-9 Terminals on single-channel module rear panel

No.	Pin	Description
1	GND	Ground
2	VF	Voltage fault indication terminal
3	DI	Digital input terminal
4	DO	Digital output terminal
⊙	I Monitor	Current monitoring output
5	Sense +	Voltage remote measuring terminal(+)
6	Sense -	Voltage remote measuring terminal(-)
7	Ext_PRG+	External analog controlling terminal(+)
8	Ext_PRG-	External analog controlling terminal(-)

Voltage failure indication

When the load is under OVP or reverse protection condition, pin 2 VF will output low level signal.

Current monitoring

Current monitoring terminal will output 0-10V analog signal to accordingly on behalf of 0 - full range of input current. You can connect an external voltmeter or an oscilloscope to display the input current's changing.

Digital I/O

Digital I/O is the pin 3 and pin 4 shown in Chapter 3.4, only used in remote control. Pin 4 digital output terminal can output TTL high/low level. It is a universal output terminal and can be used in controlling an external instrument, for example, the relay used in power testing. DI is used to detect the external level state.

External analogue control



You can control the voltage and current setting of the electronic load by the analogue terminals: pin 7 and pin 8. 0-10V adjustable analogue simulate the 0-fullscale to regulate the input voltage and current of the electronic load (10V indicate the full range of load voltage or current value)

Chapter4 Operations introduction

This chapter will mainly introduce IT8700's menu operation function.

4.1 Local/remote operation







The front panel has keyboard controls for setting voltage, current, resistance and power. Local operation means control the electronic load via the keys on the front panel and the menu operation. Remote operation means control the electronic load through computer via the RS232, USB or Ethernet interface.

You can press  +  key to switch into local control.











4.2 PC control connection

IT8700 series electronic load can achieve remote control via **RS232 /USB /ETHERNET**, but only one interface can be used at one time. choose the interface via the system key (**SYSTEM**). Connect Communication cable before power on. Do not support hot plug, as it may damage communication interface of electronic load. The following picture shows how to connect RS232 cable between electronic load and PC and show the specific configuration.

Procedure:

1. Connect RS232 cable.
2. Power on the electronic load
3. Select channel number via  key, such as channel1
4. Enter system menu via  +  key, use  to choose <communication>, press  key to enter, use  key to choose RS232, press  key to confirm.

RS232
 USB TMC-USB488
 GPIB
 ETHERNET

5. Now Display return to main menu, use  key to choose <RS232> menu, press  key to enter. First set <Baudrate Set>, use  +  key to choose and enter; use  key to choose<Parity Set>, use  +  key to choose <none> and confirm; Use  key to choose<Handshake Set>, use  +  key to choose<None> and confirm.

Baudrate Set
 Parity Set
 Handshake Set
 Exit

Note:  means to press this key to choose.

4.3 Operating modes

The electronic load can work in the following 4 modes:

Constant current operation mode (CC)

Constant voltage operation mode (**CV**)

Constant resistance operation mode (**CR**)

Constant power operation mode (**CW**)

4.3.1 Constant current (CC) mode

In this mode, the electronic load will sink a current in accordance with the programmed value regardless of the input voltage. See figure 4-1.

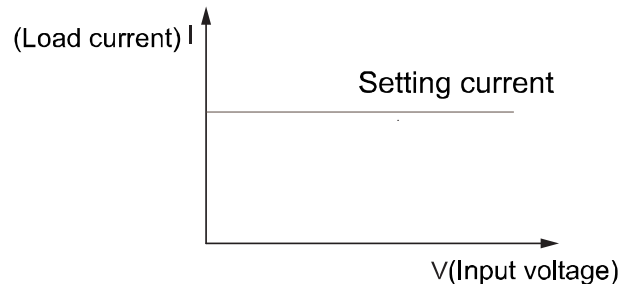

Fig 4-1 CC mode

Ranges

When work in CC mode, you can press **Setup** key to enter the menu, when it show RANGE, you can select either of the two overlapping ranges: <LOW RANGE> or <HIGH RANGE>. Current can be edited in either of the two ranges. Low range will supply higher accuracy and better resolution when you set lower current. If any value you set is outside the maximum value of the LOW RANGE, you should select HIGH RANGE. If the electronic load work in remote control mode (USB / RS232 / Ether-net) , you can use CURR:RANG command to switch current range.

Immediate Current value

Set the current level via front panel or sending command (CURR <n>), if the load is in CC mode, the new setting current level immediately changes the input at a rate determined by the slew rate. If the load is not in CC mode, the setting current level will be saved for use, until switch to CC mode.

Triggered current level

This function only can be used in remote control mode, when the load is in the CC mode, after receive the CURR:TRIG <NRF+> command, subsequent triggers will have no effect on the input unless another triggering signal is sent. CURR command will cover the CURR:TRIG <NRF+> value, this function is used to synchronize Multi-channel input load changes.

Transient current level

Set A/B transient current level on front panel or by remote operation, the load can continuously toggle between the two levels when transient operation is turned on.

Set slew rate

The current slew rate determines the rate at which the input current to a module changes to a new programmed value. You can set current level's rise/fall slew rate on the front panel or by remote operation. The slew rate programmed act in effect to the immediate, triggered and transient current level changes.

4.3.2 Constant resistance (CR) mode

In this mode, the electronic load was equivalent to a constant resistance, as shown below; the electronic load will linearly change the current according to the input voltage. See figure 4-2.

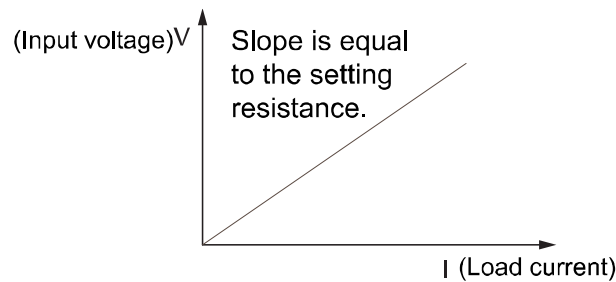

Fig 4-2 CR mode

Ranges

You can select the lower or higher range for CR mode too. When it shows RANGE, you can select either of the two overlapping ranges: <LOW RANGE> or <HIGH RANGE>. Resistance can be edited in either of the two ranges. Low range will supply higher accuracy and better resolution when you set lower resistance. If any value you set is outside the maximum value of the LOW RANGE, you should select HIGH RANGE. If the electronic load work in remote control mode (USB / RS232 / Ether-net), you can use RES:RANG command to resistance range.

Immediate resistance level

Set the resistance level via front panel or sending command (RES <n>), if the load is in CR mode, the new setting resistance level immediately changes the input at a rate determined by the slew rate. If the load is not in CR mode, the setting resistance level will be saved for use, until switch to CR mode.

Triggered voltage level

This function only can be used in remote control mode, when the load is in the CR mode, after receive the RES:TRIG <NRF+> command, subsequent triggers will have no effect on the input unless another triggering signal is sent. RES command will cover the RES:TRIG <NRF+> value, this function is used to synchronize Multi-channel input load changes.

Limited current value

Set limited current value under CR mode.

Transient resistance level

Set A/B transient resistance level on front panel or by remote operation, the load can continuously toggle between the two levels when transient operation is turned on.

4.3.3 Constant voltage (CV) mode

In this mode, the electronic load will attempt to sink enough current to control the source voltage to the programmed value. See figure 4-3.

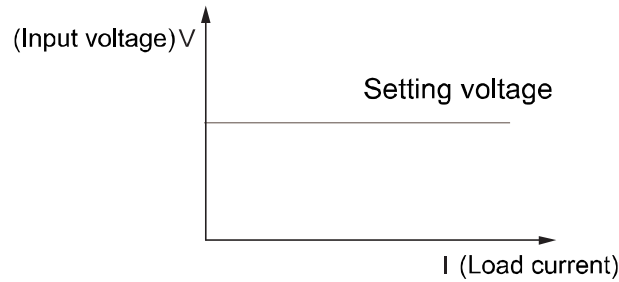

Fig 4-3 CV mode

Ranges

You can select the lower or higher range for CV mode too. Voltage can be edited in either of the two ranges. Low range will supply higher accuracy and better resolution when you set lower range. If any value you set is outside the maximum value of the low range, you should select high range. If the electronic load work in remote control mode (USB / RS232 / Ether-net) , you can use VOLT:RANG command to voltage range.

Voltage level

Set the voltage level on front panel or by sending SCPI command (VOLT <n>) , if the load is in CV mode, the new setting immediately changes the input at a rate determined by the voltage slew rate. If the load is not in CV mode, the set voltage level will be saved in the instrument for use, until switch to CV mode.

Triggered voltage level

This function only can be used in remote control mode, when the load is in the CV mode, after receive the VOLT:TRIG <NRF+> command, subsequent triggers will have no effect on the input unless another triggering signal is sent. VOLT command will cover the VOLT:TRIG <NRF+> value, this function is used to synchronize Multi-channel input load changes.

Limited current value

Set limited current value under CV mode.

CV loop speed

This item can set the CV Loop response speed: high speed or low speed.

Transient resistance level

Set A/B transient voltage level on front panel or by remote operation, the load can continuously toggle between the two levels when transient operation is turned on.

4.3.4 Constant power (CW) mode

In CW mode, electronic load will consume a constant power. As shown in fig4-4, when input voltage increase, the input current will decrease, while power will remain the same. $P=(V*I)$.

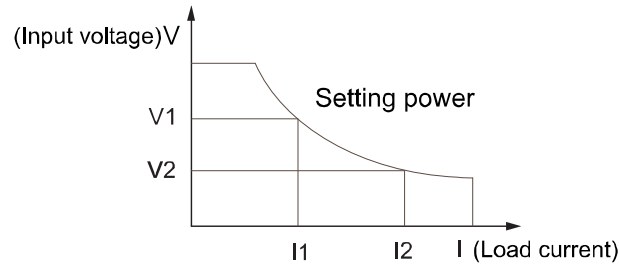

Fig 4-4 CW mode

Ranges

You can select the lower or higher range for CW mode too. Power can be edited in either of the two ranges. Low range will supply higher accuracy and better resolution when you set lower power. Any value you set is outside the maximum value of the LOW RANGE, you should select HIGH RANGE.

Immediate power level

You could set the power level via front panel. If the load is in CW mode, the new setting power level immediately changes the input at a rate determined by the slew rate. If the load is not in CW mode, the setting power level will be saved for use until switch to CR mode.

Limited current value

Set limited current value under CW mode.

Transient power level

Set A/B transient power level on front panel or by remote operation, the load can continuously toggle between the two levels when transient operation is turned on.

4.3.5 Compound Operation Mode

IT8700P series electronic load has four compound operation modes: CV+CC, CV+CR(CR-LED), CR+CC and CW+CC. These four compound operation modes add A-Limit (limited current value) setting function under CV/CR/CW mode, which can help engineers solve the transient surge current problems, avoid to trigger the protection function and protect DUT from burning.

- The CV+CC mode can be applied to the load simulation battery and test the charging station or the car charger. When the CV is working, the maximum loading current is limited.

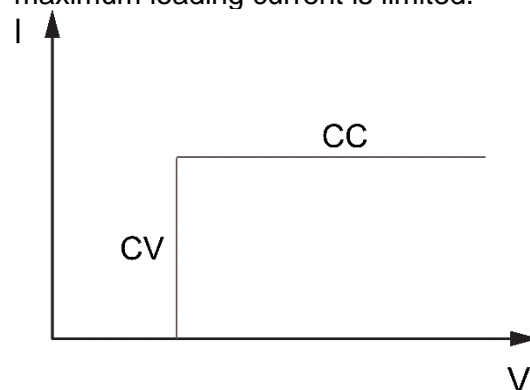

- The CR+CC mode is commonly used in the testing of voltage limiting, current limiting characteristics, constant voltage accuracy, and constant

current accuracy of car chargers, which prevents over-current protection of car chargers.

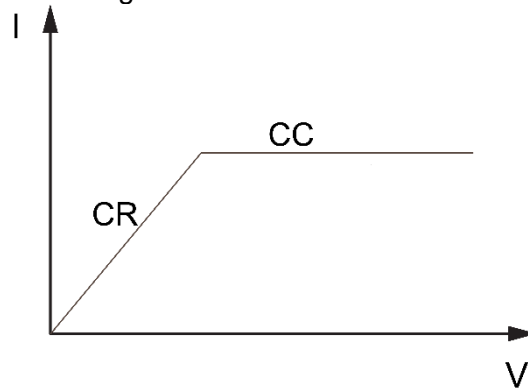

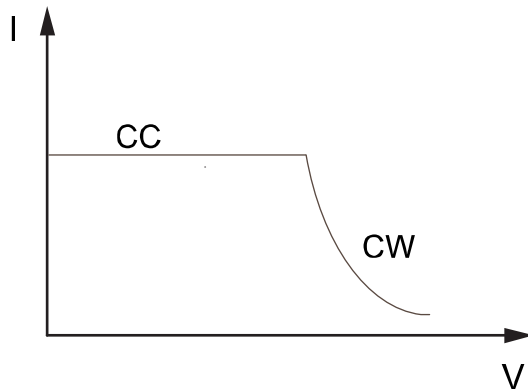

- The CW+CC mode is often used to UPS battery test, simulate the current change when the battery voltage is decaying. It can also be used to simulate the characteristics of the inputs of DC-DC converters and inverters.







4.3.6 Operations





The following will show you how to set operation mode on front panel. Take CC mode as an example:

1. Power on the electronic load
2. Press  or  keys to select the channel to be edited, such as channel 1













```
CH01 CC OFF
Vdc=0.0000V
Adc=0.0000A
Wdc=0.00W
```

3. Press  key to enter the channel setup menu, press  key to enter the mode selection menu <Mode>, press  key to select the mode CC/CV/CR/CW, such as CC, press  key to confirm.



```
CH01
Mode=CC
RANGE=HIGH
Iset=9.000A
```

4. Press  key to enter range selection menu <Range>, press  key to enter the mode selection menu <Mode>, press  key to select, such as <low range>, press  key to confirm.

```
CH01
```

- >High Range
Low Range
5. Press  key to enter the current setting <lset>, such as set the current to be 1.25A, press  key to confirm. If any error, press Esc to back.
CH01
Const Current
Set= 1.25A
Enter Esc
 6. Press  key to enter the maximum voltage value setting, press  .
Press numeric key to set the maximum voltage value.
CH01
Voltage Upper
Limit=82.000V
Enter Esc
 7. Press  key to enter the minimum voltage value setting, press  .
Press numeric key to set the minimum voltage value.
CH01
Voltage Lower
Limit=0.000V
Enter Esc
 8. Press  key to enter the rise slope setting, such as set the rise slope to be 1A/uS. Press  key to confirm
CH01
Rise Speed Set
= 1.00A/uS
Enter Esc
 9. Press  key to enter the fall slope setting, such as set the fall slope to be 2A/uS. Press  key to confirm
CH01
Fall Speed Set
= 2.00A/uS
Enter Esc
 10. Press  key to exit
 11. Press  to open the load's input
CH1 CC ON
Vdc=0.0000V
Adc=0.0000A
Wdc=0.00W

4.4 Transient operation

Transient operation enables the module to periodically switch between two load levels, as might be required for testing power supplies. Transient operation can be turned on and off at the front panel ( and  keys), before you turn on the operation, you should set the parameters associated with transient operation (). The parameters include: A level, A width, B level, B width, and transient testing modes.

The transient testing modes have 3 kinds: continuous, pulsed, or toggled.

- Continuous: Generates a respective pulse stream the toggles between two load levels
- Pulse: Generates a load change that returns to its original state after some

time period

- **Toggle:** Generates a repetitive pulse stream that toggles between two load levels. Similar to continuous mode except that the transient points are controlled by explicit triggers instead of an internal transient generator.

4.4.1 Continuous

In CC mode, transient testing can be used to check the stability of the source voltage. Transient function has two current levels (A level, B level), which should be in the same range (high range or low range). You can set the A/B level delay time and the rise/fall slew via the main frame keyboard. The slew rate determines the rate which the level changes at. Press **Trig** key, the load will continuously switch between the A/B levels preset. Transient load are usually used to test the power supply's performance under load continuous changing conditions. Figure 4-6 shows the current waveform of continuous transient operation mode.

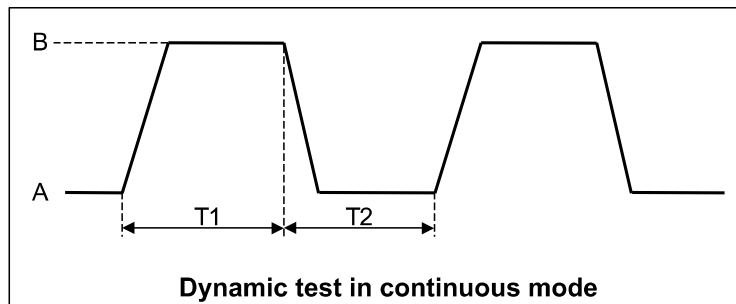

Fig 4-6 continuous transient operation current waveform

4.4.2 Pulsed

In pulsed mode, you can set A/B value via mainframe keyboard or remote control. A/B rise/fall rate and delay time should be the same. The electronic load will automatically switch to A level, after maintaining A width time, switch to B level, it won't switch to A level until the instrument receive the pulse signal. The following picture shows the current waveform in pulse transient operation.

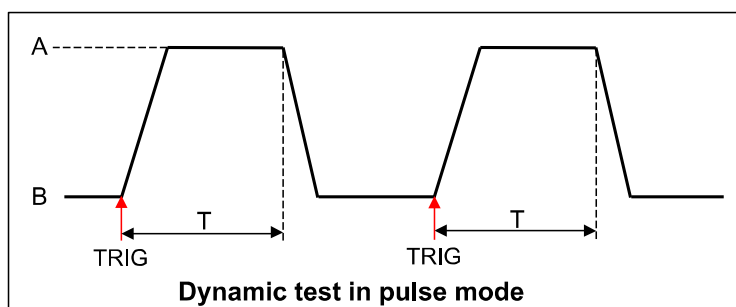

Fig 4-7 pulsed mode current waveform

4.4.3 Toggled

In toggle mode, the electronic load will switch between A level and B level when receiving a triggering signal after the transient operation is enabled. The following picture shows the current waveform in toggle transient operation.

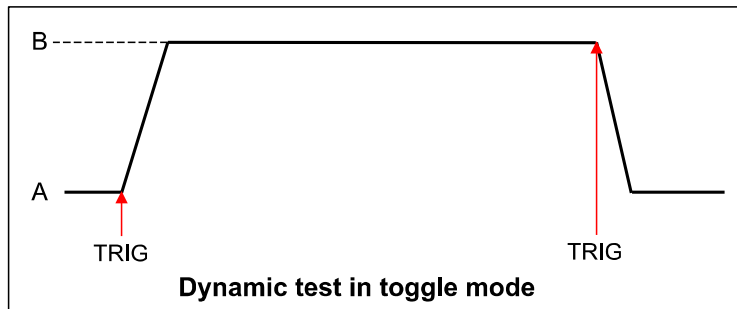



















Fig 4-8 toggled mode current waveform

4.4.4 A/B transient operations

The following will show you how to set operation mode on front panel. Take CC mode as an example:

1. Power on the electronic load
2. Press  ,  keys to select the channel to be edited, such as channel 1
 CH01 CC OFF
 Vdc=0.0000V
 Adc=0.0000A
 Wdc=0.00W
3. Press  key to enter the channel setup menu, press  key to enter the mode selection menu <Mode>, press  key to select the mode CC/CV/CR/CW, such as CC, press  key to confirm
 CH01
 Mode=CC
 RANGE=HIGH
 Iset=9.000A
4. Press  key to enter range setting <Range>, press  key to enter the mode selection menu <Mode>, press  key to select, such as <low range>, press  key to confirm.
 CH01
 High Range
 Low Range
5. Press  key to enter the rise slope <I>, such as set the current to be 1A/uS, press  key to confirm
 CH01
 Rise Speed Set
 = 1.00A/Us
6. Press  key to enter the fall slope setting <I>, such as set the rise slope to be 2A/uS. Press  key to confirm
 CH01
 Fall Speed Set
 = 2.00A/Us
7. Press  key to enter A LEVEL setting <TRANa>, such as 10.00A, press  key to confirm
 Transition A
 Level = 10.00A
8. Press  key to enter A level width setting <Ta>, such as 0.003S,

press **Enter** key to confirm

Tran A Width
0.003S

9. Press **▼** key to enter B level setting <TRANb>, such as 2.00A, press **Enter** key to confirm

Transition B
Level = 2.00A

10. Press **▼** key to enter B level width setting <Tb>, such as 0.002S, press **Enter** key to confirm

Tran. B Width=
0.002S

11. Press **▼** key to set transient operation mode <Tmode>, such as continuous mode, press **Enter** key to confirm

CH01
>Continuous
Pulse
Toggle

12. Press **Esc** key to exit

13. Press **Shift** + **4** keys to enter system menu function, press **▼** key to select <Trigger source>, such as select <Manual> on the front panel, press **Enter** key to confirm

Manual
External
Hold
Bus
Timer

14. press **Esc** key to confirm.

15. Press **On/Off** to open the load's input.

16. Press **Tran** to enable transient operation.

17. Press **Trig** key to trigger.

If in the remote control mode (USB / RS232 / Ether-net), you can refer to the following example to edit transient operation(refer to IT8700 programming guide to get more).

CURRent:TRANsient:MODE CONTInous

CURRent:TRANsient:ALEVel 5

CURRent:TRANsient:AWIDth 0.6mS

CURRent:TRANsient:BLEVel 10

CURRent:TRANsient:BWIDth 0.7mS

TRANsient ON

TRIGger:IMMEDIATE

4.5 List operation

List mode lets you generate complex sequences of input changes with rapid, precise timing, which may be synchronized with internal or external signals. This is useful when running test sequences with a minimum amount of

overhead.

Generate complex sequences to complete complex tests by editing LIST: Select different trigger resource, editing the step value, width time and slew rate of every step. The parameters of List operation include the name, number of steps (2-84 for all the modules), single step width time (0.000020s~3600s for all the modules) and every step's set value and slew rate. The list file can be saved in non-volatile memory, used to fast recall. And the modules can edit up to 7 groups list files.

In list operation mode, the load begin to enable the list operation once receive the trigger signal, until the list operation is completed or the instrument receive another trigger signal.

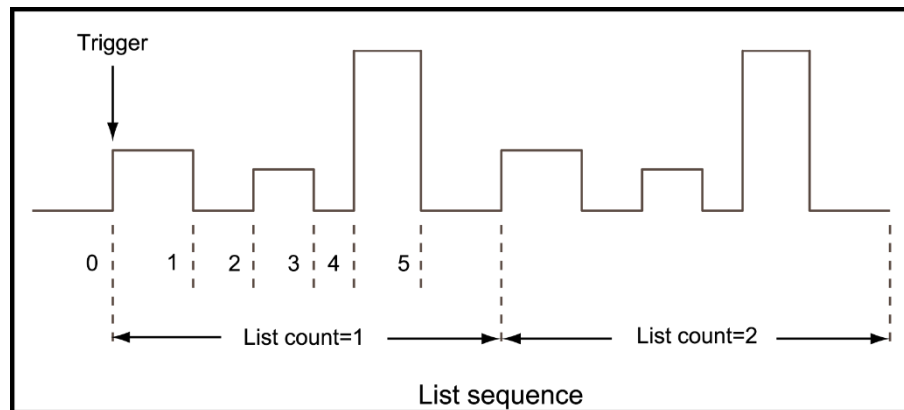







Fig 4-9 List mode current waveform

LIST operation mode







The following will show you how to set operation mode on front panel. Take IT8732P as an example:

1. Power on the electronic load.
2. Press  ,  keys to select the channel to be edited, such as channel 1.

```
CH01 CC OFF
Vdc=0.0000V
Adc=0.0000A
Wdc=0.00W
```

3. Press  +  (System) keys to enter system menu function, press  key to select <Trigger Source>, such as select <Manual>on the front panel, press  key to confirm.

```
Manual
External
Hold
Bus
Timer
```

4. Press  to close the load's input.
5. Press  +5, press  key to select <list>, press  key to confirm, press  key to select List<Edit list>, press  key to confirm.

```
Function Mode
Recall List
Edit List
```

6. Set the CV Loop response speed: high speed or low speed, press **Enter** to confirm.
 High Rate
 Low Rate
7. Select high/low ranges, such as low range, press **Enter** to confirm.
 High range
 Low range
8. Select Lists steps, such as 5 steps, press **Enter** to confirm.
 List file step
 = 5
9. Set the first step's current, such as 1A, press **Enter** key to confirm.
 Step 001 level
 = 1A
10. Set the first step's rise slew rate, such as 1A/uS press **Enter** key to confirm.
 Step 001 rate
 = 1A/uS
11. Set the first step's time, such as 6S. press **Enter** key to confirm.
 Step 001 width
 = 6S
12. Set the second step's current, such as 0A. press **Enter** key to confirm
 Step 002 level
 = 0A
13. Set the second step's rise slew rate, such as 1A/uS. Press **Enter** to confirm.
 Step 002 rate
 = 1A/uS
14. Set the second step's time, such as 5S. press **Enter** to confirm.
 Step 002 width=5S
15. Set the 3rd to 5th steps in same procedure as 0.5A/ 1A/us /4S, 0A/ 1A/us /2S, 2A/ 1A/us /3S.
16. Select repeat running times, such as 1, press **Enter** to confirm.
 Repeat count= 1
17. Select the position to save file, such as 1, press **Enter** to confirm.
 CH01
 Save list file = 1
18. Press **▲** key to select <function mode>, press **Enter** key to confirm, press **▲** key to select <list>, press **Enter** to confirm.
 Fixed
 List
19. Press **Esc** to exit.
20. Press **On/Off**, open the load's input.
21. Press **Trig** to trigger.

If in the remote control mode (USB / RS232 / Ether-net), you can refer to the following example to edit list operation (refer to IT8700 programming guide to get more).

```

LIST:MODE CURRent
LIST:RANGe 40
LIST:COUNT 10000
LIST:STEP 4
LIST:LEVEL 1,5
LIST:SLEW 1,2
LIST:WIDTH 1,1
LIST:LEVEL 2,1
LIST:SLEW 2,2
LIST:WIDTH 2,2
FUNCTION:MODE LIST
TRIGger:IMMIdiate
  
```

4.6 Triggered operation

4.6.1 Trigger function

Trigger operation can be used in the following operations: transient pulse output, triggered output and list output. The electronic load have 5 kinds of trigger modes to Synchronously trigger the tested instrument, before enable the trigger function, users should first select trigger source.

4.6.2 Trigger source

- Keyboard (**Trig** key) trigger: when the keyboard trigger mode is active, press **Trig**, will enable a trigger operation.
- External trigger signal(TTL level): the 1st pin of the 8 pins connector on the rear panel of the main frame is trigger input terminal, when external trigger signal is available, input a low pulse(>10uS) to the internal, the load will enable a trigger operation.
- Bus trigger: when bus trigger is available, as soon as the load receive a trigger command (*TRG) from the communication port, the load will enable a trigger operation.
- Timer trigger: when timer trigger is available, the main frame will enable a trigger operation periodically.
- Trigger maintenance: when trigger maintenance is available, only when the load receive the trigger command (TRIG:IMM) from the communication port, the load will enable a trigger operation.

4.7 Short operation

The load can simulate a short circuit at its input. During front panel operation, you can press **Short** key to switch short on/off states. Short operation won't affect the present setting. When turn off the short state, the load returns to the original set state.

The actual value of the electronic in short operation depends on the mode and range active when the short is turned on. In CC, CR mode, the maximum short current is 120% of the current range. In CV mode, short means setting the load's constant voltage to be 0V.

When in remote control mode (USB / RS232 / Ether-net) , you can send SCPI command INPut:SHORT ON to enable the short operation.

4.8 Input on/off operation

In front panel operation conditions, press **On/Off** key to switch to on/off state. Input on/off operation won't affect the present settings. The load/unload speed of On/off operation is not dependent on the rise/fall slew rate.

When in the remote control mode (USB / RS232 / Ether-net) , you can send SCPI command INPut ON to open input.

4.9 Synchronous load

To any channels, press **Shift** + **Config** key to enter configuration menu, set SYNC ON SET to be ON. When turn on this function, **On/Off** key can control the input state of the correspondent module synchronously.

When in remote control mode (USB / RS232 / Ether-net) , you can send SCPI command INPut:ALL ON to synchronously load all channels.

4.10 Von operation

When testing some power supply products with a slower voltage rise, if the input of the electronic load is turned on first, and then the power is turned on, the power supply may enter the protected state. Therefore, the user can set the VON value, and when the power supply voltage is higher than this value, the electronic load starts to load.

CAUTION

Please confirm whether you need to set the VON voltage. The VON voltage is set to facilitate the user to limit the working voltage, and if you do not need to set the VON voltage, do not set this value, otherwise it may result in unloading.

IT8700 series electronic loads offer Von loading voltage and Von loading mode.

- When disable Von LATCH, voltage rise and is higher than the Von loading voltage, input of electronic load is turned on. When the power supply's voltage fall and is lower than Von unload value, input is turned off.

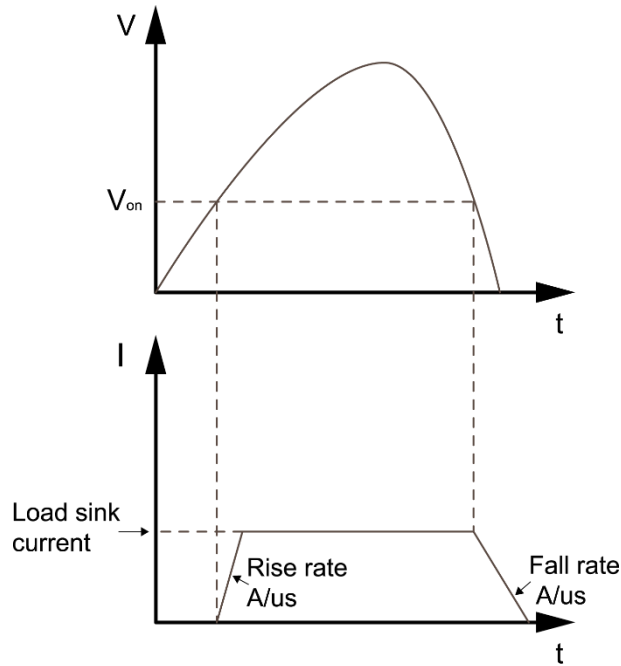

Fig 4-10 VON LATCH load's working range

- When enable Von LATCH, voltage rise and is higher than the Von loading voltage, input of electronic load is turned on. When the power supply's voltage fall and is lower than Von unload value, input won't be turned off.

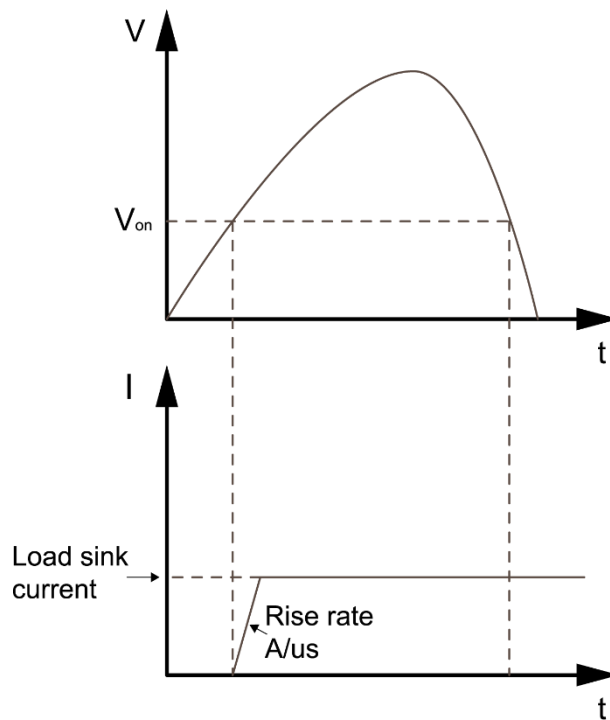

Fig 4-11 VON LATCH load's working range

Von function panel operations

1. Power on the electronic load
2. Select a channel, such as channel 1

```
CH01 CC OFF
Vdc=0.0000V
Adc=0.0000A
```

Wdc=0.00W

3. Press **Shift** + **5** to enter configuration menu
 Sync On Set
 Von
 Measure Rate
4. Press **▼** to select <Von>, press **Enter** to enter. First set <Von point>, press **Enter** key to enter, input the programmed value, such as 1V, press **Enter** key to confirm
 Von point
 Von Latch
 Exit
5. Press **▼** to select <Von Latch>, press **Enter** key to enter, select Latch to enable on/off state, such as On, press **Enter** key to confirm
6. Press **Esc** key to exit
7. Open the load's input

When in remote control mode (USB / RS232 / Ether-net), you can send SCPI command VOLT:ON <n> to set Von value; send VOLT:LATch ON to enable Von LATCH function.

4.11 Protection functions

Load has the following protection functions: over voltage protection (OVP), over current protection (OCP), over power protection (OPP), over temperature protection (OTP), reverse voltage alarm (LRV/RRV).

The mainframe will act appropriately once any of the above protection is active. You can press any button on front panel to restore the protection function. For example, the electronic load come into over temperature protection, the buzzer will alarm, the input will automatically shut down and Main frame VFD will display OTP.

4.11.1 Over voltage protection (OVP)

If the OVP circuit has triggered, buzzer alarm, the main frame screen will displays (OVP), the condition will remain until they are reset.

Operations to clear the OVP state:

Check whether the input voltage is in the load's rated voltage or the programmed protecting voltage ranges. If it is outside of the range, please disconnect the instrument under test. Press any key on the front panel (or send command PROTection:CLEar), the (OVP) displayed on the front panel will disappear, load exits OVP protection state.

4.11.2 Over current protection (OCP)

The electronic load includes both hardware and software over current protection features.

- Hardware OVP: load's maximum input current will be limited at about 110% of the current range, once the hardware OCP is triggered, the status register's OC bit will be set; when the hardware OCP is removed, the status register's OC bit will be reset. Hardware over current protection won't affect load's on/off state.
- Software OCP: users can set load's software OCP value, steps: **Shift** +

⑤ >Protect>Alimit set ON, Apoint set OCP current value, Adelay set delay time before alarm. When the software OCP function is active, if the load current value is over the over current protection set value, load will automatically off, VFD displays OCP. At the same time, the OC and PS bits in the status register will be set and they will remain until they are reset.

Operations to clear the OCP state:

Check whether the input current is within the load's rated current or the programmed protecting current ranges, if it is outside the range, please disconnect the instrument under test. Press any key on the front panel (or send command PROTECTION:CLEAR), the (OCP) displayed on the front panel will disappear, load exits OCP protection state.

4.11.3 Over power protection (OPP)

The electronic load includes both hardware and software OPP features.

- Hardware OPP: the electronic load allows user to set a power protection limit in hardware which will limit the power in the range you set when the OPP condition occur. Hardware OPP will not change the load ON/OFF state.
- Software OPP: users can set load's software OPP value, steps: Shift+5>Protect>Point set OPP power value, Plimit set alarm delay. If the load power value is OPP delay time, load will automatically turned off, VFD will display OPP. At the same time, the OP and PS bits in the status register will be set and they will remain until they are reset.

Operations to clear the OPP state:

Check whether the input power is in the rated power range or the programmed protecting ranges. If it is outside the range, please disconnect the instrument under test. Press any key on the front panel (or send command PROTECTION:CLEAR), the (OPP) displayed on the front panel will disappear, load exits OPP protection state.

4.11.4 Over temperature protection (OTP)

When load's internal circuit temperature is over 85°C, load will enable OTP. Input will automatically turned off, VFD display OTP. At the same time the OT and PS bits in the status register will be set, they will remain until they are reset.

Operations to clear the OTP state:

when load temperature dropped to the protecting point, press any key on the front panel(or send command PROTECTION:CLEAR), the (OTP) displayed on the front panel will disappear, load exits OTP protection state.

4.11.5 Reverse voltage alarm (LRV)

Once in reverse connection condition, main frame screen displays LRV, and they will remain until the reverse connection is eliminated.

Operations to clear the reverse voltage state:

Check whether the connection is reversed. If so, disconnect the object to be measured.

4.12 Save and recall operation

The stored setting of all channels can be recalled, the stored parameters includes working mode, voltage/ current value, slew rate, transient setting and so on. It can save up to 101 groups of setting parameters. The 0th group can be used as boot parameters. The 1st to 100th groups can be used as automatic

testing parameters. All the parameters are saved in the nonvolatile memory, won't lose even in power down state. You can use SAVE key to save parameters, press RECALL key to fast recall.

Save and recall operations

- After setting the parameters, press **Save** key to save, press number 9, press **Enter** to confirm

Save Group
0

- Press **Recall** key, press **9**, to recall the saved data

Recall Group
0

4.13 Automatic test function

IT8700 series electronic load has a very strong automatic test function. The automatic test function is useful for simulating various tests and allows the user to edit up to 10 groups of testing files. It helps engineers to test out all kinds of data of the tested power supply at different loading status. Automatic test function can edit multiple product tests, such as CC, no-load, short-circuit, CV, so it can finish all test by one time. It makes tests convenient and fast, and ensures high efficiency and testing accuracy.

Edit testing files

1. Power on the electronic load
2. Press **Shift** + **6** key to enter the menu
Run Program
Recall Prog
Edit Program
Exit
3. Press **▼** key to move menu to > EDIT PROGRAM to edit testing files
4. Press **Enter** key to enter the next menu.

Take example of IT8702, IT8702 can be max extended to be 16 channels, 0 represent the number of IT8702 main frame, 1 stands for the number of the extended main frame. 07 05 03 01 indicate 1/3/5/7 channels have been equipped with loads, next to the main frame is channel 1, the others followed are numbered in order. Press numeric keys to select the channel to be tested, 07050301 changes to 07Y0Y01, it stands for 3/5 is selected to be edited. Press **Enter** to confirm.

Active Channel

0: □□□□□□□□

1: 07 05 03 01

5. Select the steps needed to test, if you want to test 4 steps, please press in order 1/2/3/4, 0 stands for the tenth step. If you want to cancel a step, press again the numeric keys you want to cancel. Press **Enter** to confirm.

Active SEQ.

0 9 8 7 6 5 Y Y Y Y

6. In the 4 steps, if you want to suspend, e.g. you want to suspend step 2, press numeric key 2, press **Enter** to confirm

Pause Sequence

□□□□□ 4 3 Y 1

7. Edit the 1st step of the 4 steps: determine whether need short circuit testing in channel 3 and 5, for example, channel 3 need short circuit testing, press number 3. press **Enter** to confirm

SEQ01 Short CH

0: □□□□□□□□

1: □□□5□Y□□

8. Set with-load time, if you want to load 2S, press numeric key 2, then press **Enter** to confirm

SEQ01 On Time

= 2.0 S

9. Set unloading time, if you need 2S, press numeric key 2, then press **Enter** to confirm

SEQ01 Off Time

= 2.0 S

10. Set testing delay time, e.g. 1S, press numeric key 1. T_{pf} is testing delay time.

SEQ01 P/F Delay

Time = 1.0 S

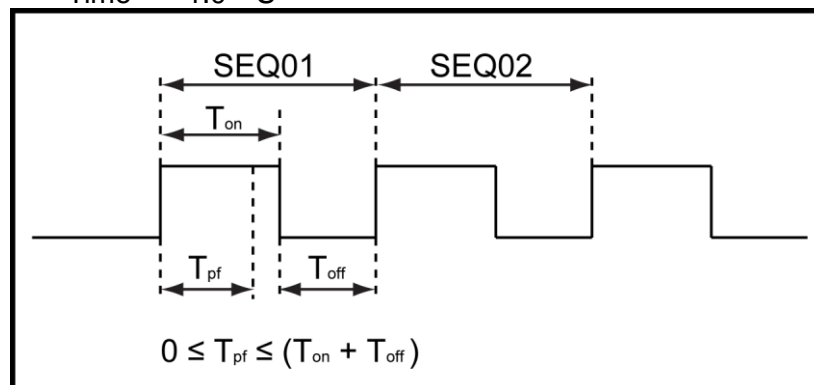

T_{pf} is testing delay time

11. Repeat 7) ~10), set the rest 3 steps' loading/unloading time
12. Set the condition when stop testing, Complete mean stop test When all the steps are completed, Failure mean stop test when the testing fails. Press **▲** , **▼** keys to select, such as <Complete>, press **Enter** key to confirm.

Stop Condition >

> Complete

Failure

13. Whether you need to link to the next file to be tested, if you need to link to group 2, press number key 2, 0 stands for not linking to other files. Press **Enter** key to confirm.

Program Chain

NO: 0

14. Save the edited files in Eeprom, you can save up to 10 groups of files, e.g please press numeric key **1** to save the edited file in group 1, and then press **Enter** to confirm.

Save Program

NO: 1















15. Press  key twice to exit.







NOTE

In the following editing procedures, "Y" indicates selected status. To cancel selected status, press numeric key of corresponding step again. The above steps only set entire framework of auto tests. Additional setting is required for specific parameters in each step. This design will facilitate modification of parameters in a single step.

Edit Auto Test Step Parameter





1. Select the channel you want to edit, then edit every group's every step, we select channel 3 and channel 5 in above, press  ,  keys to switch channels, after selecting channel 3.
2. Press  key
 > MODE =CC
 Range=HIGH
 Iset =1.00 A
3. You can edit every step's mode, > MODE =CC, press  key to enter the menu, press  ,  key to select mode, for example, select > Const Current, press  to confirm. Press  to select range, for example, RANGE=HIGH, press  to enter the menu.
 > Const Current
 Const Voltage
 Const Resis.
4. Press  key, move the cursor to > Iset =1.00 A, press  to enter the menu, set the working current, for example, set 1A, press numeric key  , then press  to confirm.
 Const Current
 Set = 1.000A
5. Press  to move the cursor to Vmax=82.000V, you need to set the high limit of testing voltage, press  to enter the menu.

In this example, the first step is 5.8V, press  ,  ,  keys, then press  key to confirm.

Voltage Upper

Limit = 5.800V



6. Press  key to move the cursor to Vmin=0.000V, you need to set the low limit of testing voltage, press  key to enter the menu.



In this example, the first step is 0.15V, press  ,  ,  ,  keys, then press  key to confirm. After editing the first step of channel 3,

press  key to exit.

Voltage Lower

Limit = 0.150V

7. Press   keys to select channel 5, in order to select the first step of channel 5, repeat 1) ~6) steps, after editing the menu, press  key to exit.

8. Then save the edited first step of channel 3 and channel 5, press  and numeric key 1 to save step 1 in the same way, you can edit the rest 3 steps of channel 3 and channel 5. After saving, press  to confirm.

Save Gropu

1



NOTE









Settings at each step should be independently saved. Saving positions of step parameters are related to save group and step number of auto test files. If the auto test file is saved in group 1, the saving position of step parameter is consistent with the step number; if the auto test file is saved in group 2, the saving position is 1+ step number, for example, steps 1, 2 and 3 are saved in 11, 12 and 13 respectively; if the auto test file is saved in group 3, the saving position is 2+ step number, for example, steps 1, 2 and 3 are saved in 21, 22 and 23 respectively, and so on. Refer to the following table for saving position.

Correspondence Table of Auto test files and step parameter saving.

Program 1	Sequence	1	2	3	4	5	6	7	8	9	10
Save Group		1	2	3	4	5	6	7	8	9	10
Program 2	Sequence	1	2	3	4	5	6	7	8	9	10
Save Group		11	12	13	14	15	16	17	18	19	20
	:										
	:										
Program 10	Sequence	1	2	3	4	5	6	7	8	9	10
Save Group		91	92	93	94	95	96	97	98	99	100

Recall testing files and Run testing files

The following way can make you fast recall the edited testing files from EEPROM after re-powering.

- Press  +  to enter the menu
 - Run Program
 - Recall Prog
 - Edit Program
 - Exit
- Press  to move to <Recall Prog> to recall the saved testing files.
- Press  to move to <Run Program>.
- Press  key to start automatic testing, if you need to pause, press  key, then press  key to continue test by one step. press  key to continue the test until the test is finished.

4.14 CR-LED Test Function

With adding of diode break-over voltage setting in the IT8700 series electronic load under conventional CR mode, the electronic load only works when voltage applied at its both ends is higher than the diode break-over voltage to give a real simulation of diode working principle, i.e., the ripple current at real LED test.

The I-V curve of LED is as shown below. Under conventional CR mode, the electronic load only simulates the static working point of diode as shown in the red circle of the following figure. It is unable to verify the dynamic characteristics of LED under normal working conditions, and the status of accurate ripple current.

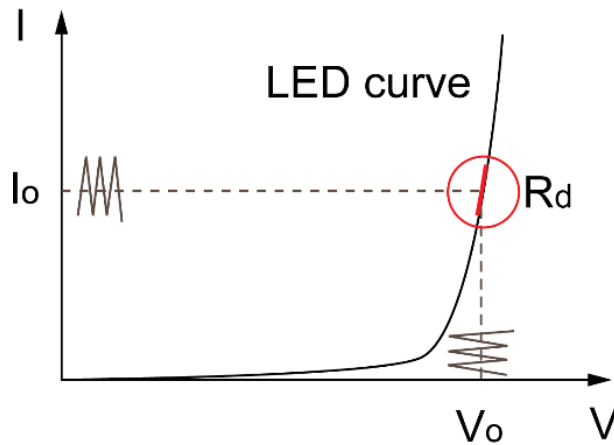

The definitions of parameters shown in the above figure are as follows:

- V_o : constant working voltage of load LED of LED constant current source;
- I_o : output current of LED constant current source;
- V_d : break-over voltage of diode (string);
- R : constant resistance.

Setting CR-LED Mode

1. Power on the electronic load.
2. Select the channel.
3. Press **Shift** + **5** to enter configuration menu
Sync On Set
4. Press **▼** key to move to CR-LED. Press **Enter** key to confirm.
On
Off (Default)
5. Press **Esc** key to exit.
6. Press **Setup** key to enter the setup menu.
MODE= CC
7. Press **Enter** key to enter the mode selection menu <Mode>, press **▼** key to select the mode CR, press **Enter** key to confirm.
Const Current
Const Voltage
>Const Resis.
8. Press **▼** key to move to Rset=7500.0. You need to set the constant resistance.
Const Resis.
Set=7500.0
Enter Esc
9. Press **▼** key to move to $V_d=0.000V$. Press **Enter** key to confirm. You need to set the V_d value.
CR-LED $V_{dorp}=
0.000V
Enter Esc$
10. Press **Esc** key to exit

Calculation method of V_d and R

Definition:

- V : constant working voltage of load LED of LED constant current source;

- I: output current of LED constant current source;
- V_d : break-over voltage of diode (string);
- R: constant resistance.

V-I curve of LED is as shown below.

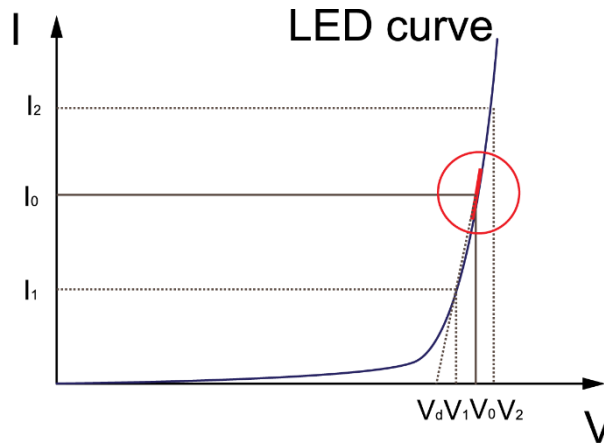

According to four parameters above and the V-I curve of LED, you can calculate the value of R and V_d .

$$R = \frac{V_2 - V_1}{I_2 - I_1}$$

$$V_d = V_0 - (I_0 \times R)$$



NOTE

The value of V_2 , V_1 , I_2 and I_1 should be close to the static working point of LED as shown in the red circle above.

Or you can calculate the value of R and V_d by the following method.

$$V_d = V \times 0.8$$

$$R = 0.2V/I$$

Chapter5 Specifications

5.1 Main technical parameters

IT8722 is double channels module which dynamically allocates power and the specification of each channel is the same.

Model		IT8722	
Rated value (0~40 °C)	Input voltage	0~80V	
	Input current	0~20A	
	Input power	250W *1	
	Min operation voltage	0.15V/3A	1.0V/20A
CV mode	Range	0~18V	0~80V
	Resolution	1mV	10mV
	Accuracy	±(0.05%+0.025%FS)	±(0.05%+0.025%FS)
CC mode	Range	0~3A	0~20A
	Resolution	0.1mA	1mA
	Accuracy	±(0.05%+0.05%FS)	±(0.05%+0.05%FS)
CR mode *2	Range	0.05Ω~10Ω	10Ω~7.5KΩ
	Resolution	16bit	
	Accuracy	0.01%+0.08S *3	0.01%+0.0008S
CW mode *5	Range	250W *4	
	Resolution	10mW	
	Accuracy	±(0.2%+0.2%FS)	
Dynamic mode			
Dynamic mode	CC Mode		
	T1 & T2	20uS~3600S/Res:1uS	
	Accuracy	5uS±100ppm	
	Rising/falling slope *6	0.0001~0.2A/uS	0.001~1.6A/uS
	Min Rising time *7	≒ 10uS	≒ 10uS
Measuring range			
Readback voltage	Range	0~18V	0~80V
	Resolution	0.1 mV	1 mV
	Accuracy	±(0.025%+0.025%FS)	±(0.025%+0.025%FS)
Readback current	Range	0~3A	0~20A
	Resolution	0.01mA	0.1mA
	Accuracy	±(0.05%+0.05%FS)	
Readback power	Range	250W	
	Resolution	10mW	
	Accuracy	±(0.2%+0.2%FS)	
Protection range			
OPP	≒ 250W		
OCP	≒ 3.3A	≒ 22A	
OVP	≒ 82V		
OTP	≒ 85°C		
Specification			
Short-circuit	Current (CC)	≒ 3.3/3A	≒ 22/20A
	Voltage (CV)	0V	
	Resistance (CR)	≒ 50mΩ	

Input impedance	300KΩ
dimension W*H*D (mm)	82*183*573
weight	5KG

- *1 Dynamically allocate power. The maximum power of single channel is 250W. The total power of both channels is less than or equal to 300W. The average power of each channel is 150W.
- *2 The voltage/current input is no less than 10% FS (FS= Full Scale)
- *3 The scope of read-back resistance is ($1/(1/R+(1/R)*0.01\%+0.08)$, $1/(1/R-(1/R)*0.01\%-0.08)$)
- *4 Dynamically allocate power. The maximum power of single channel is 250W. The total power of both channels is less than or equal to 300W.
- *5 The voltage/current input is no less than 10% FS
- *6 Ascending/descending slope: 10%-90% current ascending slope from 0 to maximum current
- *7 Minimum rise time: 10%-90% current rise time

IT8723 is double channels module which dynamically allocates power and the specification of each channel is the same.

Model		IT8723	
Rated value (0~40 °C)	Input voltage	0~80V	
	Input current	0~45A	
	Input power	300W	
	Min operation voltage	0.14V at 4.5A	1.4V at 45A
CV mode	Range	0~18V	0~80V
	Resolution	1mV	10mV
	Accuracy	$\pm(0.05\%+0.025\%FS)$	$\pm(0.05\%+0.025\%FS)$
CC mode	Range	0~4.5A	0~45A
	Resolution	0.1mA	1mA
	Accuracy	$\pm(0.05\%+0.05\%FS)$	$\pm(0.05\%+0.05\%FS)$
CR mode *1	Range	0.05Ω~10Ω	10Ω~7.5KΩ
	Resolution	16bit	
	Accuracy	0.01%+0.08S *2	0.01%+0.0008S
CW mode *3	Input voltage	300W	
	Input current	10mW	
	Input power	$\pm(0.2\%+0.2\%FS)$	
Dynamic mode			
Dynamic mode	CC mode		
	T1 & T2	20uS~3600S/Res:1uS	
	Accuracy	5uS+100ppm	
	Rising/falling slope *4	0.0001~0.25A/uS	0.001~2.5A/uS
	Min Rising time *5	$\approx 12uS$	$\approx 12uS$
Measuring range			
Readback voltage	Range	0~18V	0~80V
	Resolution	0.1 mV	1 mV
	Accuracy	$\pm(0.025\%+0.025\%FS)$	$\pm(0.025\%+0.025\%FS)$
Readback current	Range	0~4.5A	0~45A
	Resolution	0.1mA	1mA
	Accuracy	$\pm(0.05\%+0.05\%FS)$	
Readback power	Range	300W	
	Resolution	10mV	
	Accuracy	$\pm(0.2\%+0.2\%FS)$	
Protection range			
OPP	$\approx 310W$		

OCP	≒5A		≒50A
OVP	≒82V		
OTP	≒85℃		
Specification			
Short-circuit	Current (CC)	≒5/4.5A	≒50/45A
	Voltage (CV)	0V	
	Resistance (CR)	≒30mΩ	
dimension	82*183*573mm		
Weight	5KG		

*1 The voltage/current input is no less than 10% FS

*2 The scope of read-back resistance is:

($1/(1/R+(1/R)*0.01\%+0.08)$, $1/(1/R-(1/R)*0.01\%-0.08)$)

*3 The voltage/current input is no less than 10% FS

*4 Ascending/descending slope: 10%-90% current ascending slope from 0 to maximum current

*5 Minimum rise time: 10%-90% current rise time

Model		IT8731	
Rated value (0~40℃)	Input voltage	0~80V	
	Input current	0~40A	
	Input power	200 W	
	Min operation voltage	0.12V at 4A	1.2V at 40A
CV mode	Range	0~18V	0~80V
	Resolution	1mV	10mV
	Accuracy	±(0.05%+0.025%FS)	±(0.05%+0.025%FS)
CC mode	Range	0~4A	0~40A
	Resolution	0.1mA	1mA
	Accuracy	±(0.05%+0.05%FS)	±(0.05%+0.05%FS)
CR mode *1	Range	0.05Ω~10Ω	10Ω~7.5KΩ
	Resolution	16bit	
	Accuracy	0.01%+0.08S *2	0.01%+0.0008S
CP mode *3	Range	200W	
	Resolution	10mW	
	Accuracy	±(0.2%+0.2%FS)	
Dynamic mode			
Dynamic mode	CC mode		
	T1&T2	20uS~3600S /Res:1u S	
	Accuracy	5uS+100ppm	
	Rising/falling slope *4	0.0001~0.2A/uS	0.001~2A/uS
	Min Rising time *5	≒15uS	≒15uS
Measuring range			
Readback voltage	Range	0~18V	0~80V
	Resolution	0.1 mV	1 mV
	Accuracy	±(0.025%+0.025%FS)	±(0.025%+0.025%FS)
Readback current	Range	0~4A	0~40A
	Resolution	0.1mA	1mA
	Accuracy	±(0.05%+0.05%FS)	
Readback power	Range	200W	
	Resolution	10mW	
	Accuracy	±(0.2%+0.2%FS)	
Protection range			

OPP	≒210W	
OCP	≒4.4A	≒44A
OVP	≒82V	
OTP	≒85℃	
Specification		
Short-circuit	Current (CC)	≒4.4/4A
	Voltage (CV)	0V
	Resistance (CR)	≒30mΩ
Input impedance	300KΩ	
dimension	82*183*573	
weight	5KG	
safety	CE	

*1 The voltage/current input is no less than 10% FS

*2 The scope of read-back resistance is:

($1/(1/R+(1/R)*0.01\%+0.08)$, $1/(1/R-(1/R)*0.01\%-0.08)$)

*3 The voltage/current input is no less than 10% FS

*4 Ascending/descending slope: 10%-90% current ascending slope from 0 to maximum current

*5 Minimum rise time: 10%-90% current rise time

Model		IT8732	
Rated value (0~40℃)	Input voltage	0~80V	
	Input current	0~60A	
	Input power	400W	
	Min operation voltage	0.15V at 6A	1.5V at 60A
CV mode	Range	0~18V	0~80V
	Resolution	1mV	10mV
	Accuracy	±(0.05%+0.025%FS)	±(0.05%+0.025%FS)
CC mode	Range	0~6A	0~60A
	Resolution	0.1mA	1mA
	Accuracy	±(0.05%+0.05%FS)	±(0.05%+0.05%FS)
CR mode *1	Range	0.05Ω~10Ω	10Ω~7.5KΩ
	Resolution	16bit	
	Accuracy	0.01%+0.08S *2	0.01%+0.0008S
CP mode *3	Range	400W	
	Resolution	10mW	
	Accuracy	±(0.2%+0.2%FS)	
Dynamic mode			
Dynamic mode	CC mode		
	T1&T2	20uS~3600S /Res:1u S	
	Accuracy	5uS+100ppm	
	Rising/falling slope *4	0.0001~0.25A/uS	0.001~2.5A/uS
	Min Rising time *5	≒15uS	≒15uS
Measuring range			
Readback voltage	Range	0~18V	0~80V
	Resolution	0.1 mV	1 mV
	Accuracy	±(0.025%+0.025%FS)	±(0.025%+0.025%FS)
Readback current	Range	0~6A	0~60A
	Resolution	0.1mA	1mA

	Accuracy	$\pm(0.05\%+0.05\%FS)$	
Readback power	Range	400W	
	Resolution	10mW	
	Accuracy	$\pm(0.2\%+0.2\%FS)$	
Protection range			
OPP		$\approx 400W$	
OCP	$\approx 6.6A$		$\approx 66A$
OVP		$\approx 82V$	
OTP		$\approx 85^{\circ}C$	
Specification			
Short-circuit	Current (CC)	$\approx 6.6/6A$	$\approx 66/60A$
	Voltage (CV)	0V	
	Resistance (CR)	$\approx 25m\Omega$	
Input impedance		300K Ω	
dimension		82*183*573	
weight		5KG	
safety		CE	

*1 The voltage/current input is no less than 10% FS

*2 The scope of read-back resistance is:

($1/(1/R+(1/R)*0.01\%+0.08)$, $1/(1/R-(1/R)*0.01\%-0.08)$)

*3 The voltage/current input is no less than 10% FS

*4 Ascending/descending slope: 10%-90% current ascending slope from 0 to maximum current

*5 Minimum rise time: 10%-90% current rise time

Model		IT8733	
Rated value (0~40 °C)	Input voltage	0~80V	
	Input current	0~120A	
	Input power	600W	
	Min operation voltage	0.24V at 12A	2.4V at 120A
CV mode	Range	0~18V	0~80V
	Resolution	1mV	10mV
	Accuracy	$\pm(0.05\%+0.025\%FS)$	$\pm(0.05\%+0.025\%FS)$
CC mode	Range	0~12A	0~120A
	Resolution	1mA	10mA
	Accuracy	$\pm(0.05\%+0.05\%FS)$	$\pm(0.1\%+0.05\%FS)$
CR mode *1	Range	0.2 Ω ~10 Ω	10 Ω ~7.5K Ω
	Resolution	16bit	
	Accuracy	0.01%+0.08S *2	0.01%+0.0008S
CP mode *3	Input voltage	600W	
	Input current	10mW	
	Input power	$\pm(0.2\%+0.2\%FS)$	
Dynamic mode			
Dynamic mode	CC mode		
	T1 & T2	20 μ S~3600S /Res:1 μ S	
	Accuracy	5 μ S+100ppm	
	Rising/falling slope *4	0.0001~0.25A/ μ S	0.001~2.5A/ μ S
	Min Rising time *5	$\approx 35\mu$ S	$\approx 35\mu$ S
Measuring range			

Readback voltage	Range	0~18V	0~80V
	Resolution	0.1 mV	1 mV
	Accuracy	$\pm(0.025\%+0.025\%FS)$	$\pm(0.025\%+0.025\%FS)$
Readback current	Range	0~12A	0~120A
	Resolution	0.1mA	1mA
	Accuracy	$\pm(0.05\%+0.05\%FS)$	
Readback power	Range	600W	
	Resolution	10mW	
	Accuracy	$\pm(0.2\%+0.2\%FS)$	
Protection range			
OPP	$\cong 600W$		
OCP	$\cong 13.2A$	$\cong 132A$	
OVP	$\cong 82V$		
OTP	$\cong 85^{\circ}C$		
Specification			
Short-circuit	Current (CC)	$\cong 13.2/12A$	$\cong 132/120A$
	Voltage (CV)	0V	
	Resistance (CR)	$\cong 15m\Omega$	
Input impedance	$\cong 300K\Omega$		
dimension	82*183*573mm		
weight	5KG		
safety	CE		

*1 The voltage/current input is no less than 10% FS

*2 The scope of read-back resistance is:

($1/(1/R+(1/R)*0.01\%+0.08), 1/(1/R-(1/R)*0.01\%-0.08)$)

*3 The voltage/current input is no less than 10% FS

*4 Ascending/descending slope: 10%-90% current ascending slope from 0 to maximum current

*5 Minimum rise time: 10%-90% current rise time

IT8722B is double channels module which dynamically allocates power and the specification of each channel is the same.

Model		IT8722B	
Rated value (0~40 °C)	Input voltage	0~500V	
	Input current	0~15A	
	Input power	250W *1	
	Min operation voltage	0.8V/3A	4.0V/15A
CV mode	Range	0.1~50V	0.1~500V
	Resolution	1mV	10mV
	Accuracy	$\pm(0.05\%+0.05\%FS)$	$\pm(0.05\%+0.05\%FS)$
CC mode	Range	0~3A	0~15A
	Resolution	0.1mA	1mA
	Accuracy	$\pm(0.05\%+0.05\%FS)$	$\pm(0.05\%+0.05\%FS)$
CR mode *2	Range	0.3 Ω ~10 Ω	10 Ω ~7.5K Ω
	Resolution	16bit	
	Accuracy	0.01%+0.08S *3	0.01%+0.0008S
CP mode *5	Range	250W *4	
	Resolution	10mW	
	Accuracy	$\pm(0.2\%+0.2\%FS)$	
Dynamic mode			
Dynamic mode	CC Mode		
	T1 & T2	20uS~3600S/Res:1uS	
	Accuracy	5uS \pm 100ppm	

	Rising/falling slope *6	0.0001~0.1A/uS	0.001~0.5A/uS
	Min Rising time *7	≒20uS	≒20uS
Measuring range			
Readback voltage	Range	0~50V	0~500V
	Resolution	1 mV	10 mV
	Accuracy	±(0.025%+0.025%FS)	±(0.025%+0.025%FS)
Readback current	Range	0~3A	0~15A
	Resolution	0.01mA	0.1mA
	Accuracy	±(0.05%+0.05%FS)	
Readback power	Range	250W	
	Resolution	10mW	
	Accuracy	±(0.2%+0.2%FS)	
Protection range			
OPP	≒260W		
OCP	≒3.3A	≒16.5A	
OVP	≒530V		
OTP	≒85℃		
Specification			
Short-circuit	Current (CC)	≒3.3/3A	≒16.5/15A
	Voltage (CV)	0V	
	Resistance (CR)	≒260mΩ	
Input impedance	≒1MΩ		
dimension W*H*D (mm)	82*183*573		
weight	5KG		

*1 Dynamically allocate power. The maximum power of single channel is 250W. The total power of both channels is less than or equal to 300W. The average power of each channel is 150W.

*2 The voltage/current input is no less than 10% FS (FS= Full Scale)

*3 The scope of read-back resistance is ($1/(1/R+(1/R)*0.01\%+0.08)$, $1/(1/R-(1/R)*0.01\%-0.08)$)

*4 Dynamically allocate power. The maximum power of single channel is 250W. The total power of both channels is less than or equal to 300W.

*5 The voltage/current input is no less than 10% FS

*6 Ascending/descending slope: 10%-90% current ascending slope from 0 to maximum current

*7 Minimum rise time: 10%-90% current rise time

Model		IT8732B	
Rated value (0~40℃)	Input voltage	0~500V	
	Input current	0~20A	
	Input power	300 W	
	Min operation voltage	0.72V at 3A	4.8V at 20A
CV mode	Range	0~18V	0~500V
	Resolution	1mV	10mV
	Accuracy	±(0.05%+0.02%FS)	±(0.05%+0.025%FS)
CC mode	Range	0~3A	0~20A
	Resolution	0.1mA	1mA
	Accuracy	±(0.05%+0.05%FS)	±(0.05%+0.05%FS)
CR mode *1	Range	0.25Ω~10Ω	10Ω~7.5KΩ
	Resolution	16bit	
	Accuracy	0.01%+0.08S *2	0.01%+0.0008S
CP mode *3	Input voltage	300W	
	Input current	10mW	
	Input power	±(0.2%+0.2%FS)	
Dynamic mode			

Dynamic mode	CC mode		
	T1&T2	20uS~3600S /Res:1u S	
	Accuracy	5uS+100ppm	
	Rising/falling slope *4	0.0001~0.1A/uS	0.001~0.8A/uS
	Min Rising time *5	≒20uS	≒20uS
Measuring range			
Readback voltage	Range	0~18V	0~500V
	Resolution	1 mV	10 mV
	Accuracy	±(0.025%+0.025%FS)	
Readback current	Range	0~3A	0~20A
	Resolution	0.01mA	0.1mA
	Accuracy	±(0.05%+0.05%FS)	
Readback power	Range	300W	
	Resolution	10mW	
	Accuracy	±(0.2%+0.2%FS)	
Protection range			
OPP	≒310W		
OCP	≒3.3A	≒22A	
OVP	≒530V		
OTP	≒85℃		
Specification			
Short-circuit	Current (CC)	≒3.3/3A	≒22/20A
	Voltage (CV)	0V	
	Resistance (CR)	≒240mΩ	
Input impedance	≒1MΩ		
dimension	82*183*573mm		
weight	5KG		
safety	CE		

*1 The voltage/current input is no less than 10% FS

*2 The scope of read-back resistance is:
(1/(1/R+(1/R)*0.01%+0.08),1/(1/R-(1/R)*0.01%-0.08))

*3 The voltage/current input is no less than 10% FS

*4 Ascending/descending slope: 10%-90% current ascending slope from 0 to maximum current

*5 Minimum rise time: 10%-90% current rise time

Model	IT8733B		
Rated value (0~40 ℃)	Input voltage	0~500V	
	Input current	0~30A	
	Input power	500 W	
	Min operation voltage	0.54V/3A	5.4V/30A
CV mode	Range	0~18V	0~500V
	Resolution	1mV	10mV
	Accuracy	±(0.05%+0.025%FS)	
CC mode	Range	0~3A	0~30A
	Resolution	0.1mA	1mA
	Accuracy	±(0.05%+0.05%FS)	
CR mode *1	Range	0.2Ω~10Ω	10Ω~7.5KΩ
	Resolution	16bit	
	Accuracy	0.01%+0.08S *2	0.01%+0.0008S
CP mode	Range	500W	

*3	Resolution	10mW	
	Accuracy	±(0.2%+0.2%FS)	
Dynamic mode			
Dynamic mode	CC mode		
	T1 & T2	20uS~3600S/Res:1uS	
	Accuracy	5uS+100ppm	
	Rising/falling slope *4	0.0001~0.08A/uS	0.001~0.8A/uS
	Min Rising time *5	≒ 25uS	≒ 25uS
Measuring range			
Readback voltage	Range	0~18V	0~500V
	Resolution	1 mV	10mV
	Accuracy	±(0.025%+0.025%FS)	±(0.025%+0.025%FS)
Readback current	Range	0~3A	0~30A
	Resolution	0.01mA	0.1mA
	Accuracy	±(0.05%+0.05%FS)	
Readback power	Range	500W	
	Resolution	10mW	
	Accuracy	±(0.2%+0.2%FS)	
Protection range			
OPP	≒ 510W		
OCP	≒ 3.3A	≒ 33A	
OVP	≒ 530V		
OTP	≒ 85°C		
Specification			
Short-circuit	Current (CC)	≒ 3.3/3A	≒ 33/30A
	Voltage (CV)	0V	
	Resistance (CR)	180mΩ	
Input impedance	1MΩ		
dimension	82*183*573mm		
weight	5KG		
safety	CE		

*1 The voltage/current input is no less than 10% FS

*2 The scope of read-back resistance is:

($1/(1/R+(1/R)*0.01\%+0.08)$, $1/(1/R-(1/R)*0.01\%-0.08)$)

*3 The voltage/current input is no less than 10% FS

*4 Ascending/descending slope: 10%-90% current ascending slope from 0 to maximum current

*5 Minimum rise time: 10%-90% current rise time

Model		IT8722P	
Rated value (0~40 °C)	Input voltage	0~80V	
	Input current	0~20A	
	Input power	250W *1	
	Min operation voltage	0.15V/3A	1.0V/20A
CV mode	Range	0~18V	0~80V
	Resolution	1Mv	10mV
	Accuracy	±(0.05%+0.025%FS)	±(0.05%+0.025%FS)
CC mode	Range	0~3A	0~20A
	Resolution	0.1mA	1mA
	Accuracy	±(0.05%+0.05%FS)	±(0.05%+0.05%FS)
CR mode	Range	0.05Ω~10Ω	10Ω~7.5KΩ

*2	Resolution	16bit	
	Accuracy	0.01%+0.08S *3	0.01%+0.0008S
CP mode *5	Range	250W *4	
	Resolution	10mW	
	Accuracy	±(0.2%+0.2%FS)	
Dynamic mode			
Dynamic mode	CC mode		
	T1 & T2	20uS~3600S/Res:1uS	
	Accuracy	5uS±100ppm	
	Rising/falling slope *6	0.0001~0.2A/uS	0.001~1.6A/uS
	Min Rising time *7	≒ 10uS	≒ 10uS
Measuring range			
Readback voltage	Range	0~18V	0~80V
	Resolution	0.1 mV	1 mV
	Accuracy	±(0.025%+0.025%FS)	±(0.025%+0.025%FS)
Readback current	Range	0~3A	0~20A
	Resolution	0.01mA	0.1mA
	Accuracy	±(0.05%+0.05%FS)	
Readback power	Range	250W	
	Resolution	10mW	
	Accuracy	±(0.2%+0.2%FS)	
Protection range			
OPP	≒ 250W		
OCP	≒ 3.3A	≒ 22A	
OVP	≒ 82V		
OTP	≒ 85°C		
Specification			
Short-circuit	Current (CC)	≒ 3.3/3A	≒ 22/20A
	Voltage (CV)	0V	
	Resistance (CR)	≒ 50mΩ	
Input impedance	300KΩ		
dimension	82*183*573		
weight	5KG		

*1 Dynamically allocate power. The maximum power of single channel is 250W. The total power of both channels is less than or equal to 300W. The average power of each channel is 150W.

*2 The voltage/current input is no less than 10% FS (FS= Full Scale)

*3 The scope of read-back resistance is ($1/(1/R+(1/R)*0.01\%+0.08)$, $1/(1/R-(1/R)*0.01\%-0.08)$)

*4 Dynamically allocate power. The maximum power of single channel is 250W. The total power of both channels is less than or equal to 300W.

*5 The voltage/current input is no less than 10% FS

*6 Ascending/descending slope: 10%-90% current ascending slope from 0 to maximum current

*7 Minimum rise time: 10%-90% current rise time

Model		IT8723P	
Rated value (0~40 °C)	Input voltage	0~80V	
	Input current	0~45A	
	Input power	300W	
	Min operation voltage	0.14V/4.5A	1.4V/45A
CV mode	Range	0~18V	0~80V

	Resolution	1mV	10mV
	Accuracy	$\pm(0.05\%+0.025\%FS)$	$\pm(0.05\%+0.025\%FS)$
CC mode	Range	0~4.5A	0~45A
	Resolution	0.1mA	1mA
	Accuracy	$\pm(0.05\%+0.05\%FS)$	$\pm(0.05\%+0.05\%FS)$
CR mode *1	Range	0.05Ω~10Ω	10Ω~7.5KΩ
	Resolution	16bit	
	Accuracy	0.01%+0.08S *2	0.01%+0.0008S
CP mode *3	Range	300W	
	Resolution	10mW	
	Accuracy	$\pm(0.2\%+0.2\%FS)$	
Dynamic mode			
Dynamic mode	CC mode		
	T1 & T2	20μS~3600S/Res:1μS	
	Accuracy	5μS±100ppm	
	Rising/falling slope *4	0.0001~0.25A/μS	0.001~2.5A/μS
	Min Rising time *5	≒ 12μS	≒ 12μS
Measuring range			
Readback voltage	Range	0~18V	0~80V
	Resolution	0.1 mV	1 mV
	Accuracy	$\pm(0.025\%+0.025\%FS)$	$\pm(0.025\%+0.025\%FS)$
Readback current	Range	0~4.5A	0~45A
	Resolution	0.1mA	1mA
	Accuracy	$\pm(0.05\%+0.05\%FS)$	
Readback power	Range	300W	
	Resolution	10mW	
	Accuracy	$\pm(0.2\%+0.2\%FS)$	
Protection range			
OPP	≒ 310W		
OCP	≒ 5A	≒ 50A	
OVP	≒ 82V		
OTP	≒ 85℃		
Specification			
Short-circuit	Current (CC)	≒ 5/4.5A	≒ 50/45A
	Voltage (CV)	0V	
	Resistance (CR)	≒ 30mΩ	
Input impedance	300KΩ		
dimension	82*183*573		
weight	5KG		

*1 The voltage/current input is no less than 10% FS

*2 The scope of read-back resistance is:

($1/(1/R+(1/R)*0.01\%+0.08)$, $1/(1/R-(1/R)*0.01\%-0.08)$)

*3 The voltage/current input is no less than 10% FS

*4 Ascending/descending slope: 10%-90% current ascending slope from 0 to maximum current

*5 Minimum rise time: 10%-90% current rise time

Model		IT8731P
Rated value (0~40 °C)	Input voltage	0~80V
	Input current	0~40A
	Input power	200W

	Min operation voltage	0.12V/4A	1.2V/40A
CV mode	Range	0~18V	0~80V
	Resolution	1mV	10mV
	Accuracy	$\pm(0.05\%+0.025\%FS)$	$\pm(0.05\%+0.025\%FS)$
CC mode	Range	0~4A	0~40A
	Resolution	0.1mA	1mA
	Accuracy	$\pm(0.05\%+0.05\%FS)$	$\pm(0.05\%+0.05\%FS)$
CR mode *1	Range	0.05 Ω ~10 Ω	10 Ω ~7.5K Ω
	Resolution	16bit	
	Accuracy	0.01%+0.08S *2	0.01%+0.0008S
CP mode *3	Range	200W	
	Resolution	10mW	
	Accuracy	$\pm(0.2\%+0.2\%FS)$	
Dynamic mode			
Dynamic mode	CC mode		
	T1 & T2	20uS~3600S/Res:1uS	
	Accuracy	5uS \pm 100ppm	
	Rising/falling slope *4	0.0001~0.2A/uS	0.001~2A/uS
	Min Rising time *5	\cong 15uS	\cong 15uS
Measuring range			
Readback voltage	Range	0~18V	0~80V
	Resolution	0.1 mV	1 mV
	Accuracy	$\pm(0.025\%+0.025\%FS)$	$\pm(0.025\%+0.025\%FS)$
Readback current	Range	0~4A	0~40A
	Resolution	0.1mA	1mA
	Accuracy	$\pm(0.05\%+0.05\%FS)$	
Readback power	Range	200W	
	Resolution	10mW	
	Accuracy	$\pm(0.2\%+0.2\%FS)$	
Protection range			
OPP	\cong 210W		
OCP	\cong 4.4A	\cong 44A	
OVP	\cong 82V		
OTP	\cong 85 $^{\circ}$ C		
Specification			
Short-circuit	Current (CC)	\cong 4.4/4A	\cong 44/40A
	Voltage (CV)	0V	
	Resistance (CR)	\cong 30m Ω	
Input impedance	300K Ω		
dimension	82*183*573		
weight	5KG		
safety	CE		

*1 The voltage/current input is no less than 10% FS

*2 The scope of read-back resistance is:
($1/(1/R+(1/R)*0.01\%+0.08)$, $1/(1/R-(1/R)*0.01\%-0.08)$)

*3 The voltage/current input is no less than 10% FS

*4 Ascending/descending slope: 10%-90% current ascending slope from 0 to maximum current

*5 Minimum rise time: 10%-90% current rise time

Model		IT8732P	
Rated value (0~40 °C)	Input voltage	0~80V	
	Input current	0~60A	
	Input power	400W	
	Min operation voltage	0.15V/6A	1.5V/60A
CV mode	Range	0~18V	0~80V
	Resolution	1mV	10mV
	Accuracy	$\pm(0.05\%+0.025\%FS)$	$\pm(0.05\%+0.025\%FS)$
CC mode	Range	0~6A	0~60A
	Resolution	0.1mA	1mA
	Accuracy	$\pm(0.05\%+0.05\%FS)$	$\pm(0.05\%+0.05\%FS)$
CR mode *1	Range	0.05 Ω ~10 Ω	10 Ω ~7.5K Ω
	Resolution	16bit	
	Accuracy	0.01%+0.08S *2	0.01%+0.0008S
CP mode *3	Range	400W	
	Resolution	10mW	
	Accuracy	$\pm(0.2\%+0.2\%FS)$	
Dynamic mode			
Dynamic mode	CC mode		
	T1 & T2	20 μ S~3600S/Res:1 μ S	
	Accuracy	5 μ S \pm 100ppm	
	Rising/falling slope *4	0.0001~0.25A/ μ S	0.001~2.5A/ μ S
	Min Rising time *5	\cong 15 μ S	\cong 15 μ S
Measuring range			
Readback voltage	Range	0~18V	0~80V
	Resolution	0.1 mV	1 mV
	Accuracy	$\pm(0.025\%+0.025\%FS)$	$\pm(0.025\%+0.025\%FS)$
Readback current	Range	0~6A	0~60A
	Resolution	0.1mA	1mA
	Accuracy	$\pm(0.05\%+0.05\%FS)$	
Readback power	Range	400W	
	Resolution	10mW	
	Accuracy	$\pm(0.2\%+0.2\%FS)$	
Protection range			
OPP	\cong 410W		
OCP	\cong 6.6A	\cong 66A	
OVP	\cong 82V		
OTP	\cong 85 $^{\circ}$ C		
Specification			
Short-circuit	Current (CC)	\cong 6.6/6A	\cong 66/60A
	Voltage (CV)	0V	
	Resistance (CR)	\cong 25m Ω	
Input impedance	300K Ω		
dimension	82*183*573		
weight	5KG		
safety	CE		

*1 The voltage/current input is no less than 10% FS

*2 The scope of read-back resistance is:

($1/(1/R+(1/R)*0.01\%+0.08)$, $1/(1/R-(1/R)*0.01\%-0.08)$)

- *3 The voltage/current input is no less than 10% FS
 *4 Ascending/descending slope: 10%-90% current ascending slope from 0 to maximum current
 *5 Minimum rise time: 10%-90% current rise time

Model		IT8733P	
Rated value (0~40 °C)	Input voltage	0~80V	
	Input current	0~120A	
	Input power	600W	
	Min operation voltage	0.24V/12A	2.4V/120A
CV mode	Range	0~18V	0~80V
	Resolution	1mV	10mV
	Accuracy	±(0.05%+0.025%FS)	±(0.05%+0.025%FS)
CC mode	Range	0~12A	0~120A
	Resolution	1mA	10mA
	Accuracy	±(0.05%+0.05%FS)	±(0.1%+0.05%FS)
CR mode *1	Range	0.05Ω~10Ω	10Ω~7.5KΩ
	Resolution	16bit	
	Accuracy	0.01%+0.08S *2	0.01%+0.0008S
CP mode *3	Range	600W	
	Resolution	10mW	
	Accuracy	±(0.2%+0.2%FS)	
Dynamic mode			
Dynamic mode	CC mode		
	T1 & T2	20uS~3600S/Res:1uS	
	Accuracy	5uS±100ppm	
	Rising/falling slope *4	0.001~0.25A/uS	0.01~2.5A/uS
	Min Rising time *5	≒ 35uS	≒ 35uS
Measuring range			
Readback voltage	Range	0~18V	0~80V
	Resolution	0.1 mV	1 mV
	Accuracy	±(0.025%+0.025%FS)	±(0.025%+0.025%FS)
Readback current	Range	0~12A	0~120A
	Resolution	0.1mA	1mA
	Accuracy	±(0.05%+0.05%FS)	
Readback power	Range	600W	
	Resolution	10mW	
	Accuracy	±(0.2%+0.2%FS)	
Protection range			
OPP	≒ 610W		
OCP	≒ 13.2A	≒ 132A	
OVP	≒ 82V		
OTP	≒ 85°C		
Specification			
Short-circuit	Current (CC)	≒ 13.2/12A	≒ 132/120A
	Voltage (CV)	0V	
	Resistance (CR)	≒ 20mΩ	
Input impedance	300KΩ		
dimension	82*183*573		
weight	5KG		
safety	CE		

- *1 The voltage/current input is no less than 10% FS
 *2 The scope of read-back resistance is:
 ($1/(1/R+(1/R)*0.01\%+0.08), 1/(1/R-(1/R)*0.01\%-0.08)$)
 *3 The voltage/current input is no less than 10% FS
 *4 Ascending/descending slope: 10%-90% current ascending slope from 0 to maximum current
 *5 Minimum rise time: 10%-90% current rise time

Model		IT8722BP	
Rated value (0~40 °C)	Input voltage	0~500V	
	Input current	0~15A	
	Input power	250W *1	
	Min operation voltage	0.8V/3A	4.0V/15A
CV mode	Range	0.1~50V	0.1~500V
	Resolution	1mV	10mV
	Accuracy	$\pm(0.05\%+0.05\%FS)$	$\pm(0.05\%+0.05\%FS)$
CC mode	Range	0~3A	0~15A
	Resolution	0.1mA	1mA
	Accuracy	$\pm(0.05\%+0.05\%FS)$	$\pm(0.05\%+0.05\%FS)$
CR mode *2	Range	0.3Ω~10Ω	10Ω~7.5KΩ
	Resolution	16bit	
	Accuracy	0.01%+0.08S *3	0.01%+0.0008S
CP mode *5	Range	250W *4	
	Resolution	10mW	
	Accuracy	$\pm(0.2\%+0.2\%FS)$	
Dynamic mode			
Dynamic mode	CC mode		
	T1 & T2	20uS~3600S/Res:1uS	
	Accuracy	5uS±100ppm	
	Rising/falling slope *6	0.0001~0.1A/uS	0.001~0.5A/uS
	Min Rising time *7	≒ 20uS	≒ 20uS
Measuring range			
Readback voltage	Range	0~50V	0~500V
	Resolution	1 mV	10 mV
	Accuracy	$\pm(0.025\%+0.025\%FS)$	$\pm(0.025\%+0.025\%FS)$
Readback current	Range	0~3A	0~15A
	Resolution	0. 01mA	0.1mA
	Accuracy	$\pm(0.05\%+0.05\%FS)$	
Readback power	Range	250W	
	Resolution	10mW	
	Accuracy	$\pm(0.2\%+0.2\%FS)$	
Protection range			
OPP	≒ 260W		
OCP	≒ 3.3A	≒ 16.5A	
OVP	≒ 530V		
OTP	≒ 85°C		
Specification			
Short-circuit	Current (CC)	≒ 3.3/3A	≒ 16.5/15A
	Voltage (CV)	0V	
	Resistance (CR)	≒ 260mΩ	

Input impedance	$\cong 1M\Omega$
dimension	82*183*573
weight	5KG

- *1 Dynamically allocate power. The maximum power of single channel is 250W. The total power of both channels is less than or equal to 300W. The average power of each channel is 150W.
- *2 The voltage/current input is no less than 10% FS (FS= Full Scale)
- *3 The scope of read-back resistance is ($1/(1/R+(1/R)*0.01\%+0.08)$, $1/(1/R-(1/R)*0.01\%-0.08)$)
- *4 Dynamically allocate power. The maximum power of single channel is 250W. The total power of both channels is less than or equal to 300W.
- *5 The voltage/current input is no less than 10% FS
- *6 Ascending/descending slope: 10%-90% current ascending slope from 0 to maximum current
- *7 Minimum rise time: 10%-90% current rise time

Model		IT8732BP	
Rated value (0~40 °C)	Input voltage	0~500V	
	Input current	0~20A	
	Input power	300W	
	Min operation voltage	0.72V/3A	4.8V/20A
CV mode	Range	0~18V	0~500V
	Resolution	1mV	10mV
	Accuracy	$\pm(0.05\%+0.025\%FS)$	$\pm(0.05\%+0.025\%FS)$
CC mode	Range	0~3A	0~20A
	Resolution	0.1mA	1mA
	Accuracy	$\pm(0.05\%+0.05\%FS)$	$\pm(0.05\%+0.05\%FS)$
CR mode *1	Range	0.25 Ω ~10 Ω	10 Ω ~7.5K Ω
	Resolution	16bit	
	Accuracy	0.01%+0.08S *2	0.01%+0.0008S
CP mode *3	Range	300W	
	Resolution	10mW	
	Accuracy	$\pm(0.2\%+0.2\%FS)$	
Dynamic mode			
Dynamic mode	CC mode		
	T1&T2	20uS~3600S/Res:1uS	
	Accuracy	5uS \pm 100ppm	
	Rising/falling slope *4	0.0001~0.1A/uS	0.001~0.8A/uS
	Min Rising time *5	\cong 20uS	\cong 20uS
Measuring range			
Readback voltage	Range	0~18V	0~500V
	Resolution	1 mV	10 mV
	Accuracy	$\pm(0.025\%+0.025\%FS)$	$\pm(0.025\%+0.025\%FS)$
Readback current	Range	0~3A	0~20A
	Resolution	0.01mA	0.1mA
	Accuracy	$\pm(0.05\%+0.05\%FS)$	
Readback power	Range	300W	
	Resolution	10mW	
	Accuracy	$\pm(0.2\%+0.2\%FS)$	
Protection range			
OPP	\cong 310W		
OCP	\cong 3.3A	\cong 22A	
OVP	\cong 530V		

OTP	≒ 85℃		
Specification			
Short-circuit	Current (CC)	≒ 3.3/3A	≒ 22/20A
	Voltage (CV)	0V	
	Resistance (CR)	≒ 240mΩ	
Input impedance	1MΩ		
dimension	82*183*573		
weight	5KG		
safety	CE		

*1 The voltage/current input is no less than 10% FS

*2 The scope of read-back resistance is:

($1/(1/R+(1/R)*0.01\%+0.08)$, $1/(1/R-(1/R)*0.01\%-0.08)$)

*3 The voltage/current input is no less than 10% FS

*4 Ascending/descending slope: 10%-90% current ascending slope from 0 to maximum current

*5 Minimum rise time: 10%-90% current rise time

Model		IT8733BP	
Rated value (0~40 ℃)	Input voltage	0~500V	
	Input current	0~30A	
	Input power	500W	
	Min operation voltage	0.54V/3A	5.4V/30A
CV mode	Range	0~18V	0~500V
	Resolution	1mV	10mV
	Accuracy	±(0.05%+0.025%FS)	±(0.05%+0.025%FS)
CC mode	Range	0~3A	0~30A
	Resolution	0.1mA	1mA
	Accuracy	±(0.05%+0.05%FS)	±(0.05%+0.05%FS)
CR mode *1	Range	0.2Ω~10Ω	10Ω~7.5KΩ
	Resolution	16bit	
	Accuracy	0.01%+0.08S *2	0.01%+0.0008S
CP mode *3	Range	500W	
	Resolution	10mW	
	Accuracy	±(0.2%+0.2%FS)	
Dynamic mode			
Dynamic mode	CC mode		
	T1 & T2	20uS~3600S/Res:1uS	
	Accuracy	5uS±100ppm	
	Rising/falling slope *4	0.0001~0.08A/uS	0.001~0.8A/uS
	Min Rising time *5	≒ 25uS	≒ 25uS
Measuring range			
Readback voltage	Range	0~18V	0~500V
	Resolution	1 mV	10 mV
	Accuracy	±(0.025%+0.025%FS)	±(0.025%+0.025%FS)
Readback current	Range	0~3A	0~30A
	Resolution	0. 01mA	0.1mA
	Accuracy	±(0.05%+0.05%FS)	
Readback power	Range	500W	
	Resolution	10mW	
	Accuracy	±(0.2%+0.2%FS)	
Protection range			

OPP	≒510W		
OCP	≒3.3A	≒33A	
OVP	≒530V		
OTP	≒85°C		
Specification			
Short-circuit	Current (CC)	≒3.3/3A	≒33/30A
	Voltage (CV)	0V	
	Resistance (CR)	≒180mΩ	
Input impedance	1MΩ		
dimension	82*183*573		
weight	5KG		
safety	CE		

- *1 The voltage/current input is no less than 10% FS
- *2 The scope of read-back resistance is:
($1/(1/R+(1/R)*0.01\%+0.08), 1/(1/R-(1/R)*0.01\%-0.08)$)
- *3 The voltage/current input is no less than 10% FS
- *4 Ascending/descending slope: 10%-90% current ascending slope from 0 to maximum current
- *5 Minimum rise time: 10%-90% current rise time

* The above specifications may be subject to change without prior notice.

5.2 Supplementary characteristics

Storage capacity: 101 sets

Suggested calibration frequency: one time each year.

Cooling style: fan.

Fans control temperature:

Temperature	35°C	50°C	70°C	85°C
Fans status	The first grade	The second grade	The third grade	OTP

Chapter6 Remote operation

There are three kinds of communication interfaces: Ether Net, USB, RS232. The user can choose any one of them to communicate with PC.

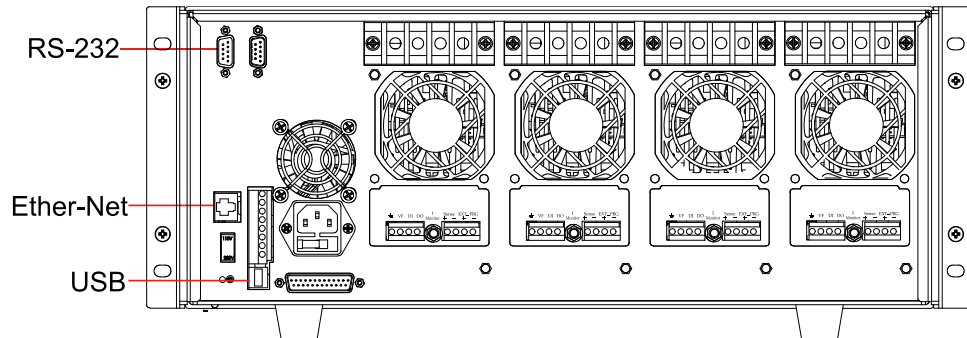

Figure 6-1IT8700 rear panel communication interface (take example of IT8702P)

6.1 RS232 interface

RS232 interface: use a cable with two COM interface (DB9) to connect load and PC. It can be activated by <Shift> + <System> key on the front panel. NOTE: There're two COM interface on the rear panel of IT8700: the left 9-pin COM interface is RS232 communication interface; the right 9-pin COM serial port connection (extended keyboard interface). All SCPI commands are available through RS-232 programming. The EIA RS-232 standard defines the interconnections between data terminal equipment (DTE) and data communications equipment (DCE). The electronic load is designed to be a DTE. It can be connected to another DTE such as a PC COM port through a null modem cable



NOTE

The RS-232 settings in your program must match the settings specified in the front panel system menu. Press <Shift> + <System>key if you need to change the settings. You can break data transmissions by sending a ^C or ^X character string to the multimeter. This clears any pending operation and discards any pending output.

RS-232 data format

The RS-232 data is a 10-bit word with one start bit and one stop bit. The number of start and stop bits is not programmable. However, the following parity options are selectable using the front panel<Shift> + <System> key. Parity options are stored in non-volatile memory.

Baud rate

The front panel <Shift> + <System> key allows the user to select one of the following baud rates, which is stored in non-volatile memory: 4800 9600 19200 38400 57600 115200.

RS-232 flow control

The RS-232 interface supports the following flow control options that are selected using the front panel <Shift> + <System>key. For each case, the electronic load will send a maximum of five characters after hold-off is asserted by the controller. The electronic load is capable of receiving up to fifteen additional characters after it asserts hold-off.

- The electronic load asserts its Request to Send (RTS) line to signal hold-off when its input buffer is almost full, and it interprets its Clear to Send (CTS) line as a hold-off signal from the controller.
- When the input queue of the electronic load becomes more than 3/4full, the instrument will send an X-OFF command. The control program should respond to this and stop sending characters until the electronic load issues the X-ON, which it will do once its input buffer has dropped below half-full. The electronic load recognizes X_ON and X_OFF sent from the controller. An X-OFF will cause the electronic load to stop outputting characters until it sees an X-ON.
- NONE there's no flow control.

Flow control options are stored in non-volatile memory.

RS-232 connections

The RS-232 serial port can be connected to the serial port of a controller (i.e., personal computer) using a straight through RS-232 cable terminated with DB-9 connectors. Do not use a null modem cable. The table below shows the pinout for the connector.

If your computer uses a DB-25connector for the RS-232interface, you will need a cable or adapter with a DB-25 connector on one end and a DB-9 connector on the other, wired straight through (not null modem).

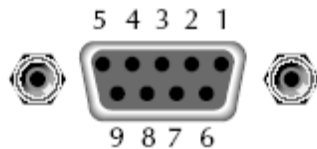

RS-232 connector pinout

pin number	description
1	no connection
2	TXD, transmit data
3	RXD, receive data
4	no connection
5	GND, signal ground
6	no connection
7	CTS, clear to send
8	RTS, ready to send
9	no connection

RS-232 troubleshooting:

If you are having trouble communicating over the RS-232 interface, check the following:

- The computer and the electronic load must be configured for the same baud rate, parity, number of data bits, and flow control options. Note that the electronic load is configured for 1 start bit and 1stop bit (these values are fixed).
- The correct interface cables or adapters must be used, as described under RS-232 connector. Note that even if the cable has the proper connectors for your system, the internal wiring may be incorrect.
- The interface cable must be connected to the correct serial port on your computer (COM1, COM2.etc.).

Communication setting

Before communication operation, please make sure that the following parameters of electronic load match that of PC.

- Baud rate : 9600(4800、9600、19200、38400、57600、115200). You can enter system menu through panel to set communication baud rate.

- Data bit : 8
- Stop bit : 1
- Parity : (none, even, odd)
 - EVEN: eight data bits with even parity
 - ODD: eight data bits with odd parity
 - NONE: eight data bits without parity
- Local address : (0 ~ 31, default setting is 0)

Parity=None	Start Bit	8 Data Bits	Stop Bit
-------------	-----------	-------------	----------

6.2 Ether Net interface

Use a network cable to connect PC through Ether-net interface of load. Then press **Shift** + **System** on the front panel to enter menu, choose <Ether-net> in <communication> item, then set gateway address<Gateway Set>, IP address <IP Set>, mask address <Mask set>, and port < port set> in Ether-net.

6.3 GPIB interface(Only for IT8700(G) series)

Firstly, connect GPIB port of load to GPIB card of PC. Please ensure that the screws have been screwed down in order to have a full connection. And then set address. The address can be set from 0 to 30. Press **Shift** + **System** key to enter system menu, press **▼** key to find GPIB address set, then enter the address, and use **Enter** to confirm. The GPIB address is stored in non-volatile memory.

6.4 USB interface

Use cables with double USB interface to connect load and PC. All electronic load functions are programmable over the USB.

The USB488 interface capabilities of the electronic load are described below:

- The interface is 488.2 USB488 interface
- The interface accepts REN_CONTROL, GO_TO_LOCAL, and LOCAL_LOCKOUT requests.
- The interface accepts MsgID = TRIGGER USBTMC command message and forwards TRIGGER requests to the function layer.

The USB488 device capabilities of the electronic load are described below:

- The device understands all mandatory SCPI commands.
- The device is SR1 capable.
- The device is RL1 capable.
- The device is DT1 capable.



NOTE

When communicating with PC, you can just select one method of all the communication methods above.

Appendix

Specifications of Red and Black Test Lines

ITECH provides you with optional red and black test cables, which individual sales and you can select for test. For specifications of ITECH test cables and maximum current values, refer to the table below.

Model	Specification	Length	Description
IT-E30110-AB	10A	1m	A pair of red and black test cables with an alligator clip at one end and a banana plug at the other end
IT-E30110-BB	10A	1m	A pair of red and black test cables with banana plugs at both ends
IT-E30110-BY	10A	1m	A pair of red and black test cables with a banana plug at one end and a Y-terminal at the other end
IT-E30312-YY	30A	1.2m	A pair of red and black test cables with Y-terminals at both ends
IT-E30320-YY	30A	2m	A pair of red and black test cables with Y-terminals at both ends
IT-E30615-OO	60A	1.5m	A pair of red and black test cables with round terminals at both ends
IT-E31220-OO	120A	2m	A pair of red and black test cables with round terminals at both ends
IT-E32410-OO	240A	1m	A pair of red and black test cables with round terminals at both ends
IT-E32420-OO	240A	2m	A pair of red and black test cables with round terminals at both ends
IT-E33620-OO	360A	2m	A pair of red and black test cables with round terminals at both ends

For maximum current of AWG copper wire, refer to table below.

AWG	10	12	14	16	18	20	22	24	26	28
The Maximum current value(A)	40	25	20	13	10	7	5	3.5	2.5	1.7

Note: AWG (American Wire Gage), it means X wire (marked on the wire). The table above lists current capacity of single wire at working temperature of 30°C. For reference only.

Contact Us

Thanks for purchasing ITECH products. In case of any doubts, please contact us as follows:

1. Visit ITECH website: www.itechate.com.
2. Select the most convenient contact method for further information.