

USER'S MANUAL

BM867s
BM869s

BRYMEN[®]
BRIGHT PEOPLE'S CHOICE

1) SAFETY

Terms in this manual

WARNING identifies conditions and actions that could result in serious injury or even death to the user.

CAUTION identifies conditions and actions that could cause damage or malfunction in the instrument.

This manual contains information and warnings that must be followed for operating the instrument safely and maintaining the instrument in a safe operating condition. If the instrument is used in a manner not specified by the manufacturer, the protection provided by the instrument may be impaired. The meter is intended only for indoor use.

The meter protection rating, against the users, is double insulation per IEC/UL/EN61010-1 Ed. 3.0, IEC/EN61010-2-030 Ed. 1.0, IEC/EN61010-2-033 Ed. 1.0, IEC/UL/EN61010-031 Ed. 1.1 and CAN/CSA-C22.2 No. 61010-1-12 Ed. 3.0 to Category IV 1000 Volts AC & DC.

Terminals (to COM) measurement category:

V / mA μ A / A :Category IV 1000 Volts AC & DC

Per IEC61010-1 2nd Ed. (2001) Measurement Category

Measurement Category IV (CAT IV) is for measurements performed at the source of the low-voltage installation. Examples are electricity meters and measurements on primary overcurrent protection devices and ripple control units.

Measurement Category III (CAT III) is for measurements performed in the building installation. Examples are measurements on distribution boards, circuit-breakers, wiring, including cables, bus-bars, junction boxes, switches, socket-outlets in the fixed installation, and equipment for industrial use and some other equipment, for example, stationary motors with permanent connection to the fixed installation.

Measurement Category II (CAT II) is for measurements performed on circuits directly connected to the low voltage installation. Examples are measurements on household appliances, portable tools and similar equipment.







WARNING

To reduce the risk of fire or electric shock, do not expose this product to rain or moisture. To avoid electrical shock hazard, observe the proper safety precautions when working with voltages above 60 VDC or 30 VAC rms. These voltage levels pose a potential shock hazard to the user. Do not touch test lead tips or the circuit being tested while power is applied to the circuit being measured. Keep your fingers behind the finger guards of the test leads during measurement. Inspect test leads, connectors, and probes for damaged insulation or exposed metal before using the instrument. If any defects are found, replace them immediately. Do not measure any current that exceeds the current rating of the protection fuse. Do not attempt a current measurement to any circuit where the open circuit voltage is above the protection fuse voltage rating. Suspected open circuit voltage should be checked with voltage functions. Never attempt a voltage measurement with the test lead inserted into the $\mu\text{A}/\text{mA}$ or A input jack. Only replace the blown fuse with the proper rating as specified in this manual. **Only use the test lead provided with the equipment or UL Listed Probe Assembly rated CAT IV 1000V or better.**

CAUTION

Disconnect the test leads from the test points before changing functions. Always set the instrument to the highest range and work downward for an unknown value when using manual ranging mode.

INTERNATIONAL ELECTRICAL SYMBOLS

	Caution ! Refer to the explanation in this Manual
	Caution ! Risk of electric shock
	Earth (Ground)
	Double Insulation or Reinforced insulation
	Fuse
	AC--Alternating Current
	DC--Direct Current

2) CENELEC DIRECTIVES

The instruments conform to CENELEC Low-voltage directive 2006/95/EC and Electromagnetic compatibility directive 2004/108/EC

3) PRODUCT DESCRIPTION

Note: Top of the line model is used as representative for illustration purposes. Please refer to your respective model for function availability.

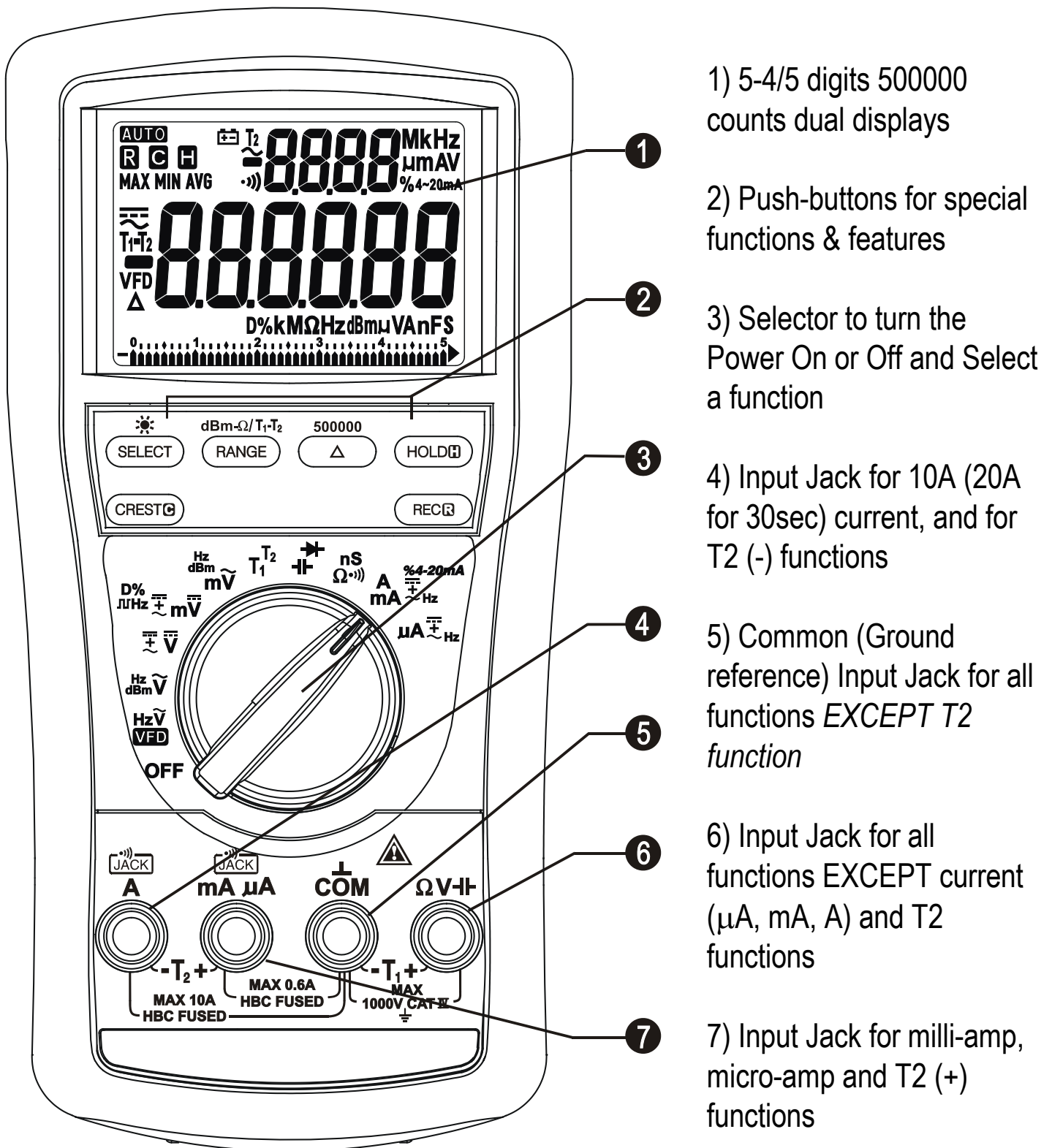

Analog bar-graph

The analog bar graph provides a visual indication of measurement like a traditional analog meter needle. It is excellent in detecting faulty contacts, identifying potentiometer clicks, and indicating signal spikes during adjustments.

Average sensing RMS calibrated

RMS (Root-Mean-Square) is the term used to describe the effective or equivalent DC value of an AC signal. Most digital multimeters use average sensing RMS calibrated technique to measure RMS values of AC signals. This technique is to obtain the average value by rectifying and filtering the AC signal. The average value is then scaled upward (calibrated) to read the RMS value of a sine wave. In measuring pure sinusoidal waveform, this technique is fast, accurate and cost effective. In measuring non-sinusoidal waveforms, however, significant errors can be introduced because of different scaling factors relating average to RMS values.

AC True RMS

AC True RMS, normally refers as True RMS, identifies a DMM function that is AC coupled, and responds accurately only to the effective RMS AC component value regardless of the waveforms. However, DC component plays an important role in the distorted non-symmetrical waveforms, and will also be of interest sometimes.

DC+AC True RMS

DC+AC True RMS calculates both of the AC and DC components given by the expression $\sqrt{DC^2 + (AC\ rms)^2}$ when making measurements, and can respond accurately to the total effective RMS value regardless of the waveform. Distorted waveforms with the presence of DC components and harmonics may cause:

- 1)Overheated transformers, generators and motors to burn out faster than normal
- 2)Circuit breakers to trip prematurely
- 3)Fuses to blow
- 4)Neutrals to overheat due to the triplen harmonics present on the neutral
- 5)Bus bars and electrical panels to vibrate

AC-Bandwidth

AC-bandwidth of a DMM is the range of frequencies over which AC measurements can be made within the specified accuracy. It is not the frequency measurement function, but is the frequency response of the AC functions. A DMM cannot accurately measure the AC value with frequency spectrums fall beyond the AC-bandwidth of the DMM. Therefore, wide AC-bandwidth plays an important role in high performance DMMs. In reality, complex waveforms, noise and distorted waveforms contain much higher frequency spectrum than its fundamental.

Crest Factor

Crest Factor is the ratio of the Crest (instantaneous peak) value to the True RMS value, and is commonly used to define the dynamic range of a True RMS DMM. A pure sinusoidal waveform has a Crest Factor of 1.4. A badly distorted sinusoidal waveform normally has a much higher Crest Factor.

4) OPERATION

CAUTION

Before and after hazardous voltage measurements, test the voltage function on a known source such as line voltage to determine proper meter functioning.

VFD ACV +Hz, VFD Hz +ACV functions (Model 869s only)

Press the **SELECT** button momentarily to toggle between the subject functions. Last selection will be saved as power up default for repeat measurement convenience. By default, voltage is always set at manual-range 500V to best cope with most Variable Frequency Drives (VFD) measurements. Press the **RANGE** button momentarily to select other ranges only when needed. High noise-rejection frequency measurement algorithm and Low-pass filter circuit are permanently bundled with all the voltage and frequency function-ranges within this rotary-switch position.

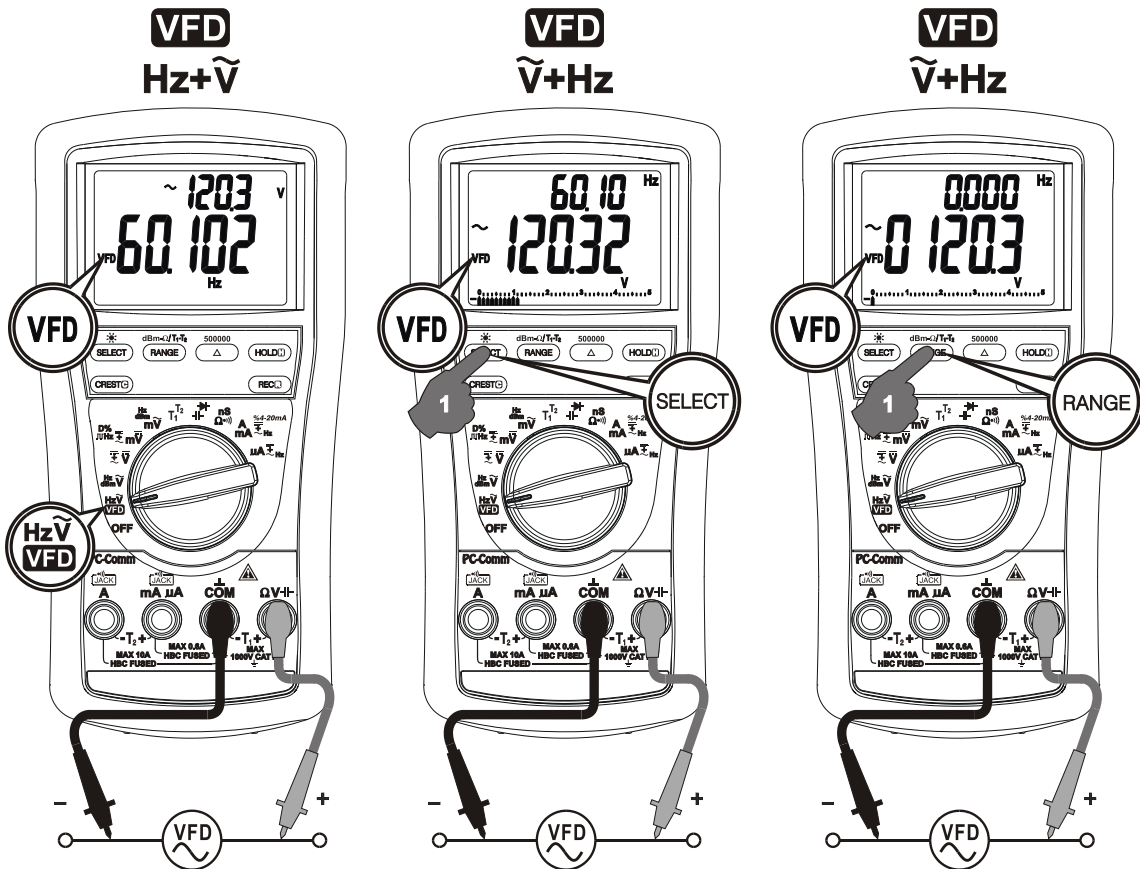

Note: Hz Input sensitivity varies automatically with voltage (current function alike) range

selected. 5V range has the highest and the 1000V range has the lowest. This VFD function defaults at the most appropriate trigger level for Variable Frequency Drive measurements. You can also press the **RANGE** button momentarily to select another trigger level (voltage range) manually. If the Hz reading becomes unstable, select higher voltage range to avoid electrical noise. If the reading shows zero, select lower voltage range for better sensitivity.

dBm +Hz, Hz +ACV, ACV +Hz functions

Press the **SELECT** button momentarily to select the subject functions in sequence. Last selection will be saved as power up default for repeat measurement convenience.

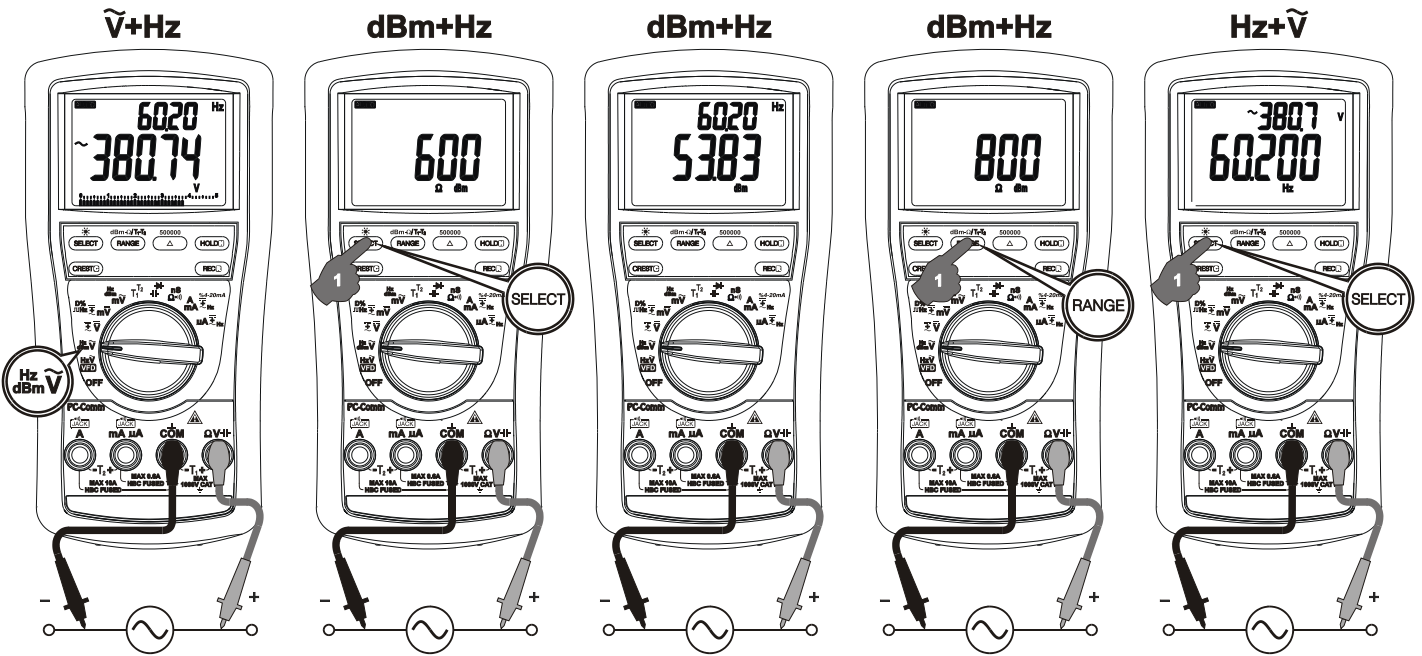

Note: Hz Input sensitivity varies automatically with voltage (current function alike) range selected. 5V range has the highest and the 1000V range has the lowest. Auto-ranging measurements normally set the most appropriate trigger level. You can also press the **RANGE** button momentarily to select another trigger level (voltage range) manually. If the Hz reading becomes unstable, select higher voltage range to avoid electrical noise. If the reading shows zero, select lower voltage range for better sensitivity.

Note: In **dBm +Hz** function, power up default reference impedance will be displayed for 1 second before displaying the dBm readings. Press **dBm-Ω (RANGE)** button momentarily to select different reference impedance of 4, 8, 16, 32, 50, 75, 93, 110, 125, 135, 150, 200, 250, 300, 500, 600, 800, 900, 1000, up to 1200Ω. Last selection will be saved as power up default for repeat measurement convenience. Manual trigger level selection on Hz reading is not available in this function.

DCV, DCV +ACV, DC+ACV +ACV functions

Press the **SELECT** button momentarily to select the subject functions in sequence. Last selection will be saved as power up default for repeat measurement convenience.

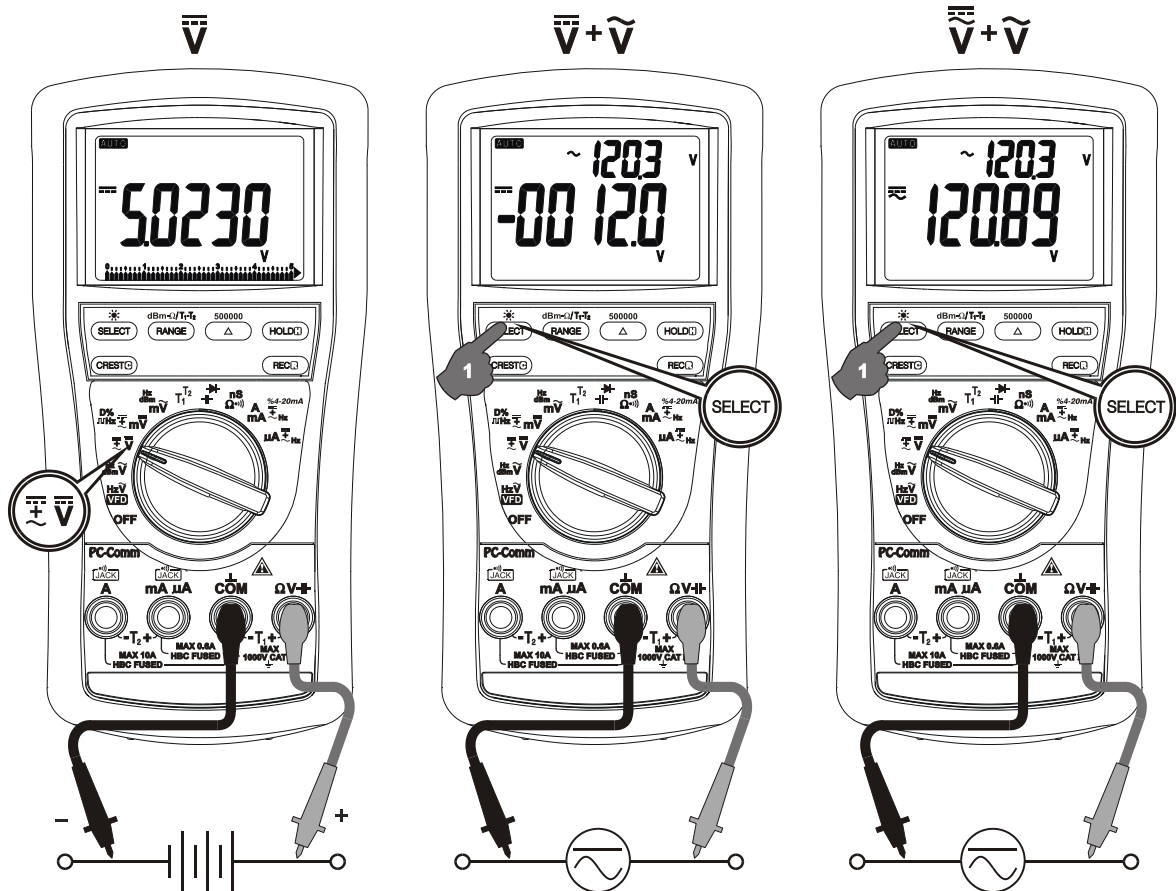

DCmV, DCmV +ACmV, DC+ACmV +ACmV, Logic-Level μ Hz, Duty% functions

Press the **SELECT** button momentarily to select the subject functions in sequence. Last selection will be saved as power up default for repeat measurement convenience.

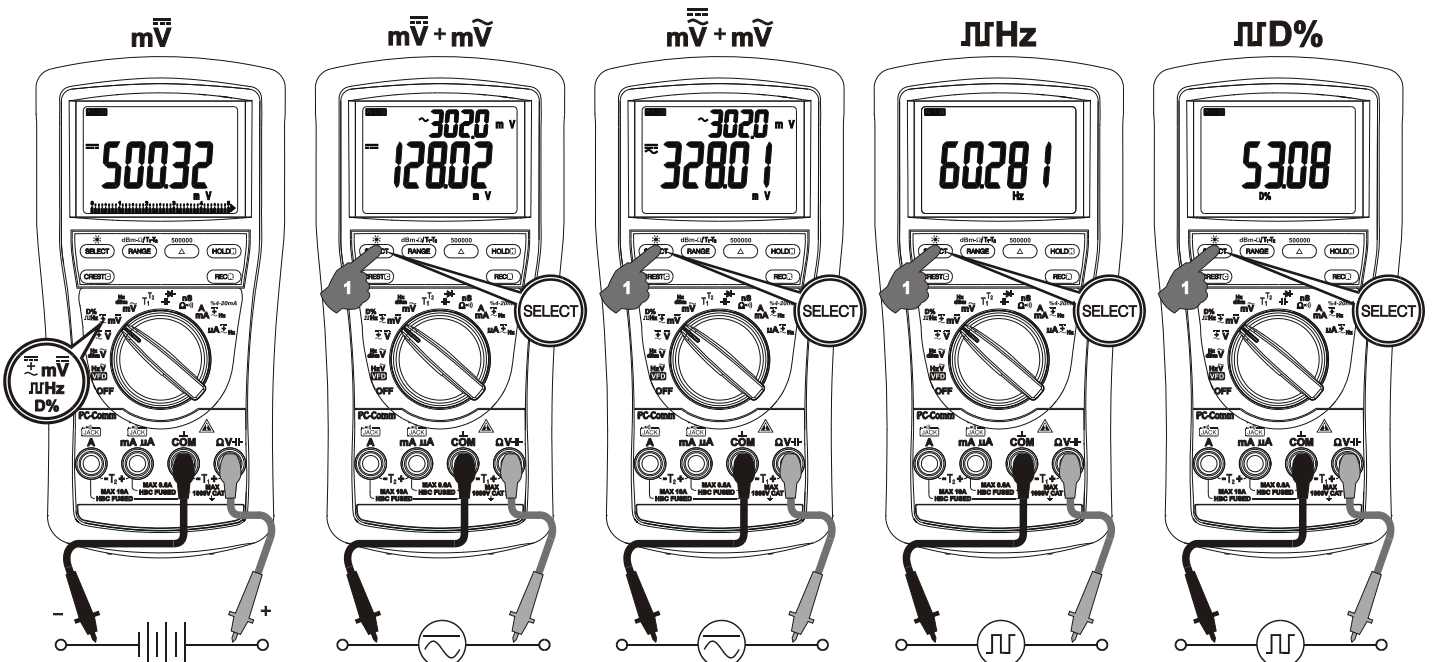

ACmV ^{+Hz}, dBm ^{+Hz}, Hz ^{+ACmV} functions

Press the **SELECT** button momentarily to select the subject functions in sequence. Last selection will be saved as power up default for repeat measurement convenience.

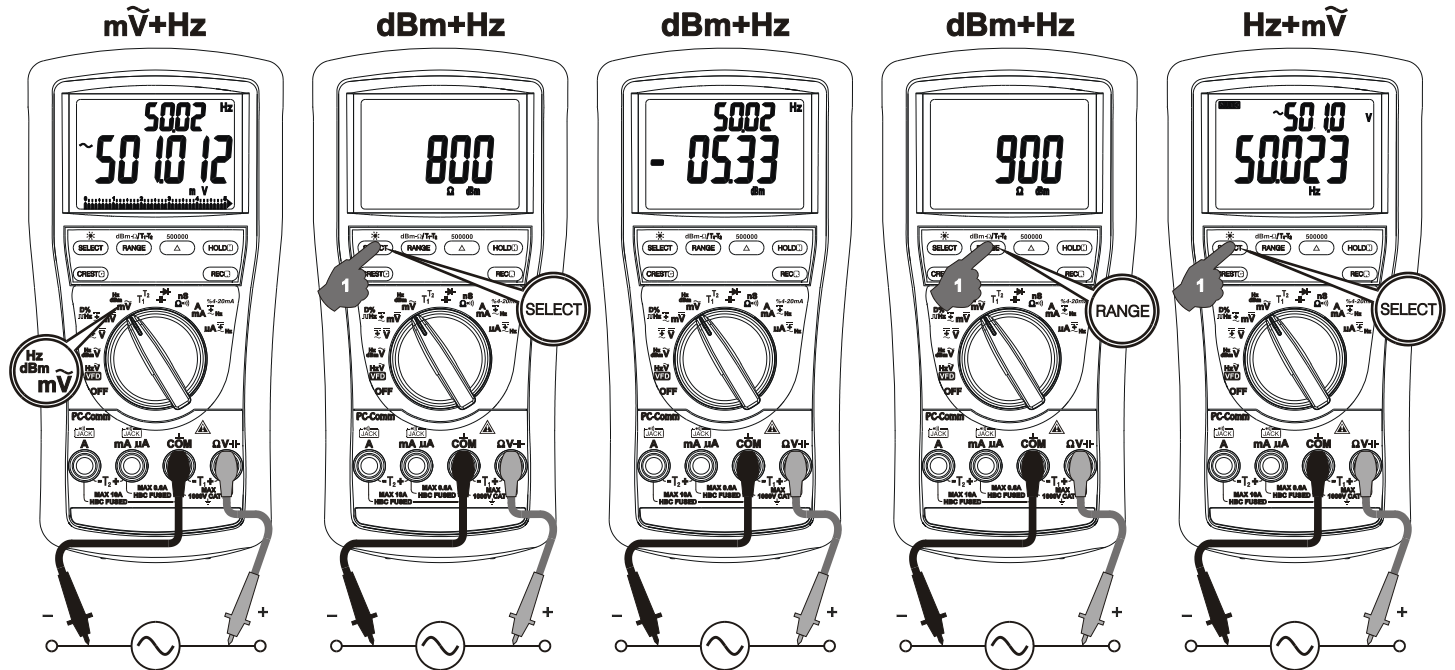

Temperature functions (Model 869s only)

Press **SELECT** button momentarily to toggle between °C and °F readings. Press **T1-T2** (**RANGE**) button momentarily can select T1, T2, T1 +T2 or T1-T2 +T2 readings. Last selection will be saved as power up default for repeat measurement convenience.

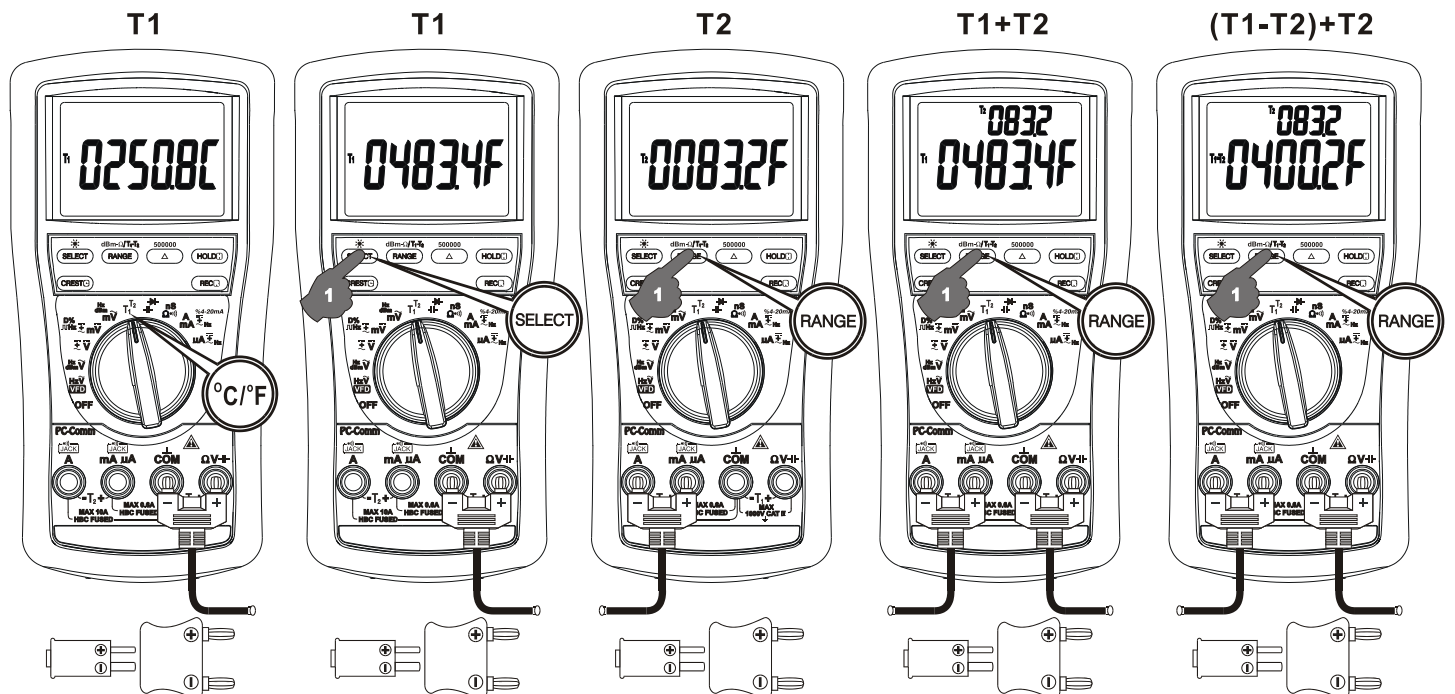

Note: Be sure to insert the banana plug type-K temperature bead probe Bkp60 with

correct **+** **-** polarities. You can also use a plug adapter Bkb32 (Optional purchase) with banana pins to type-K socket to adapt other standard type-K mini plug temperature probes.

⚡ Capacitance, ⚡ Diode test functions

For model **869s**: Press the **SELECT** button momentarily to toggle between the subject functions. Last selection will be saved as power up default for repeat measurement convenience.

For model **867s**: Direct rotary switch selection on **Capacitance** and **Diode** functions is used.

CAUTION

Discharge capacitors before making any measurement. Large value capacitors should be discharged through an appropriate resistance load.

Normal forward voltage drop (forward biased) for a good silicon diode is between 0.400V to 0.900V. A reading higher than that indicates a leaky diode (defective). A zero reading indicates a shorted diode (defective). An OL indicates an open diode (defective). Reverse the test leads connections (reverse biased) across the diode. The digital display shows OL if the diode is good. Any other readings indicate the diode is resistive or shorted (defective).

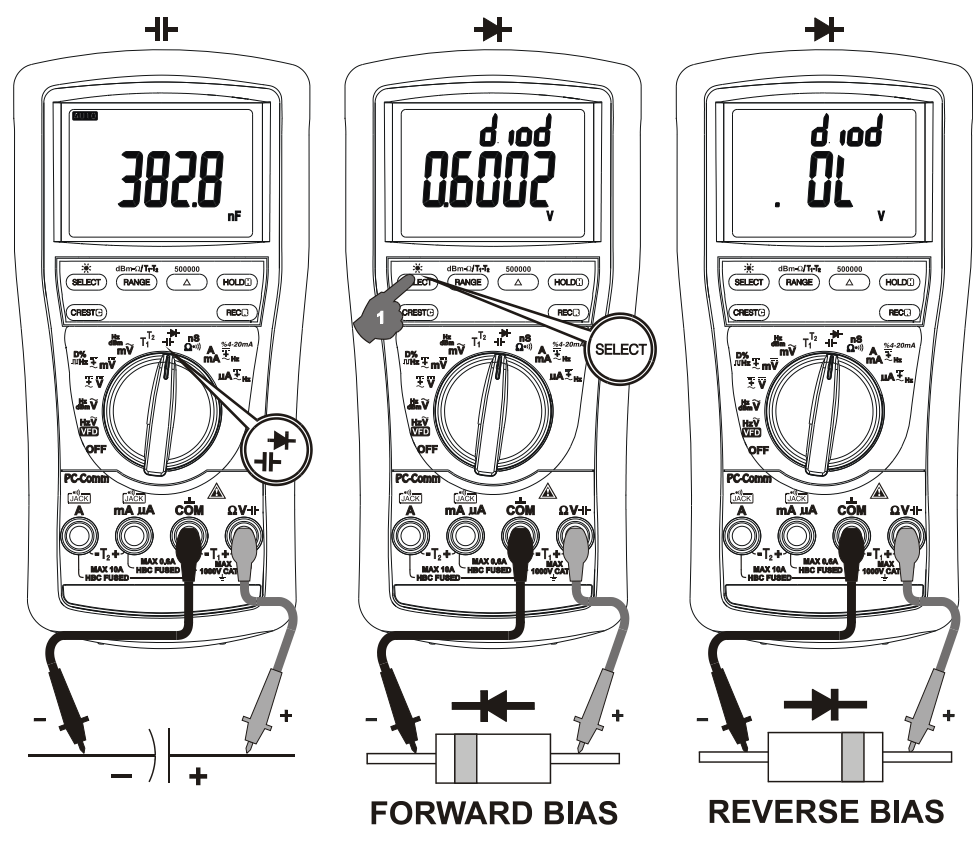

FORWARD BIAS

REVERSE BIAS

Ω Resistance, $\cdot\cdot\cdot$) Continuity, nS Conductance functions

Press the **SELECT** button momentarily to select the subject functions in sequence. Last selection will be saved as power up default for repeat measurement convenience.

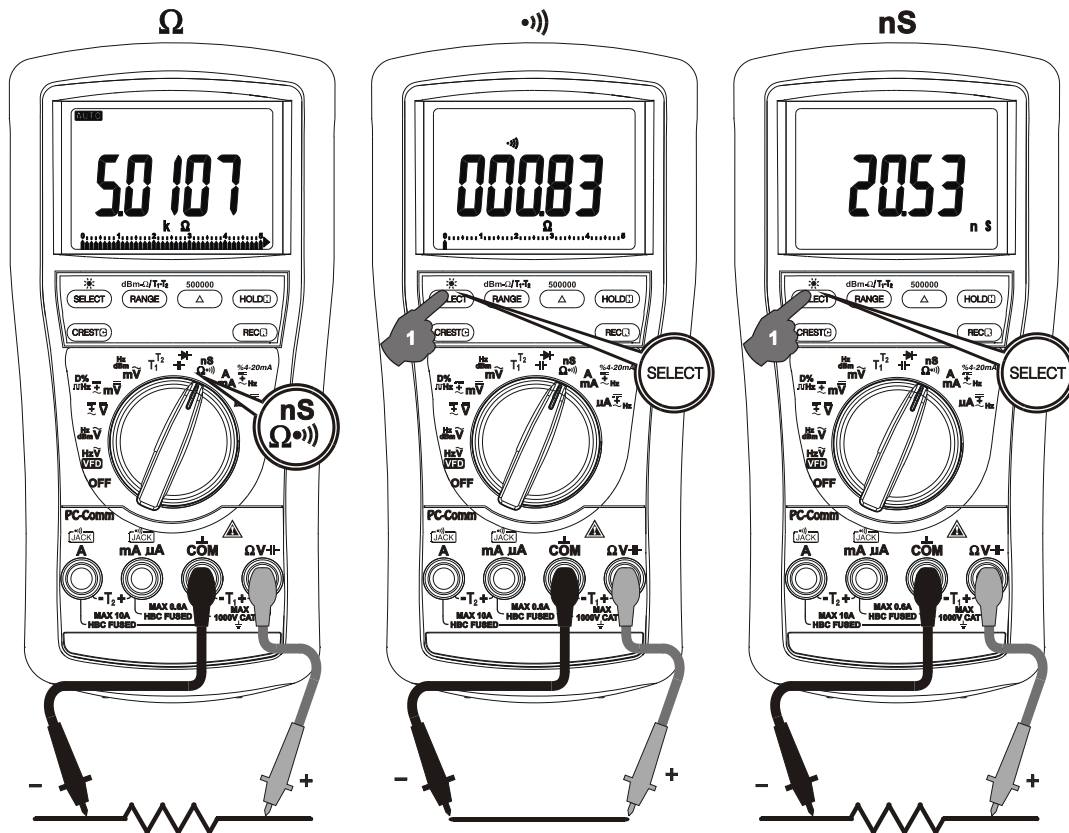

Note:

Conductance is the inverse of Resistance, that is $S=1/\Omega$ or $nS=1/G\Omega$. It virtually extends the Resistance measurements to the order of Giga-Ohms for leakage measurements.

$\cdot\cdot\cdot$) Continuity function is convenient for checking wiring connections and operation of switches. A continuous beep tone indicates a complete wire.

CAUTION

Using resistance and continuity function in a live circuit will produce false results and may damage the instrument. In many cases the suspected component must be disconnected from the circuit to obtain an accurate reading

μA , mA (DCmA with %4-20mA) and A Current functions

Press **SELECT** button momentarily to select **DC**, **DC +AC**, **DC+AC +AC** and **AC +Hz**. Last selection will be saved as power up default for repeat measurement convenience.

In DC mA function, neither in AC nor DC+AC selection, loop-current percentage (%4-20mA) reading is displayed simultaneously. It is set at 4mA = 0% (zero) and 20mA =

100% (span) with 0.01% high resolution for testing and monitoring externally powered loop current in industrial process control applications.

*Note: When measuring a 3-phase system, special attention should be taken to the phase-to-phase voltage which is significantly higher than the phase-to-earth voltage. To avoid exceeding the voltage rating of the protection fuse(s) accidentally, always consider the phase-to-phase voltage as the working voltage for the protection fuse(s).

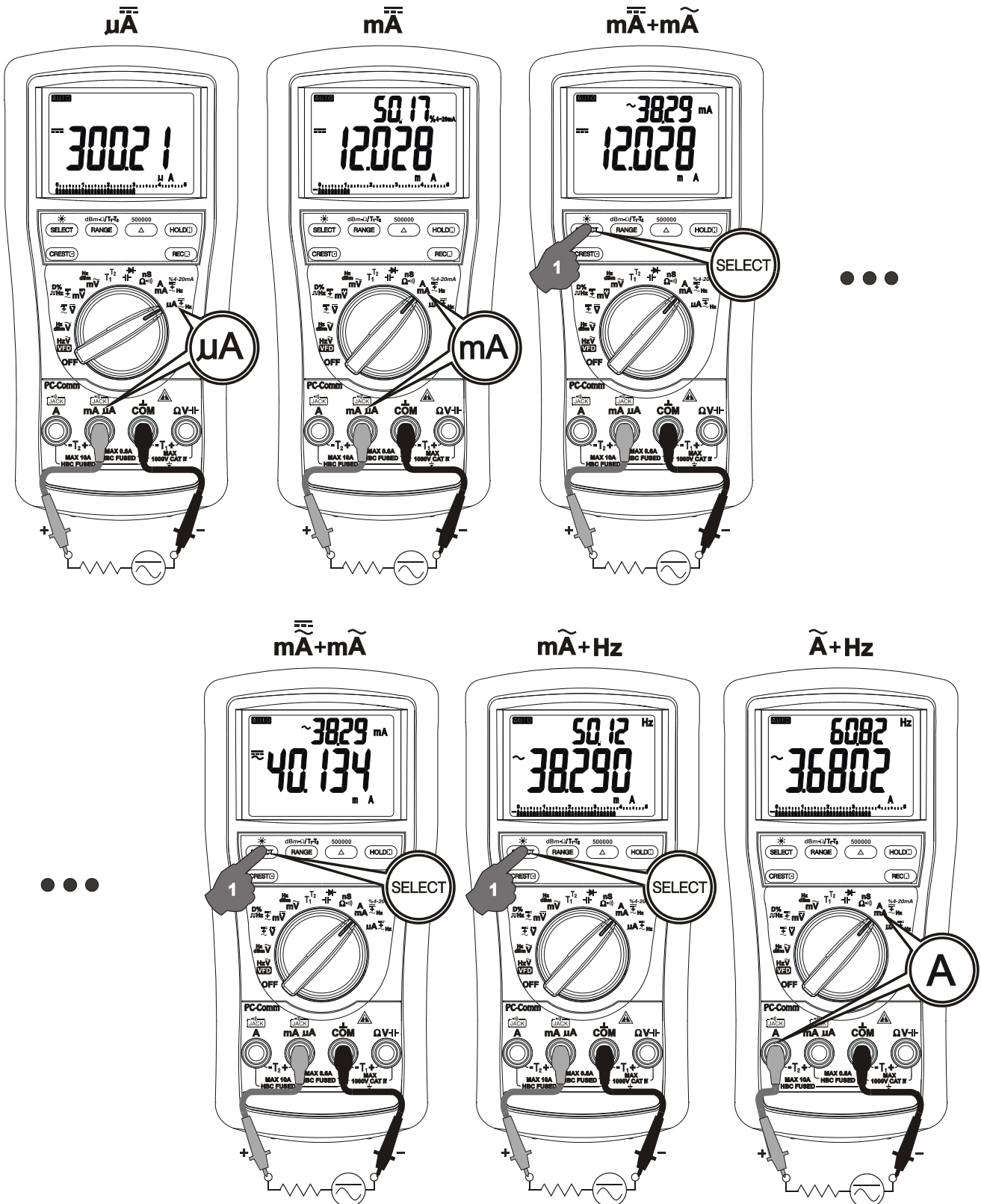

PC-COMM computer interface capabilities

The instrument equips with an optical isolated interface port at the meter back for data communication. Optional purchase PC USB interface kit BU-86X is required to connect the meter to PC computers.

MAX/MIN/AVG recording mode

Press **REC** button momentarily to activate MAX/MIN/AVG recording mode. The LCD “R” & “MAX MIN AVG” turn on. The meter beeps when new MAX (maximum) or MIN (minimum) reading is updated. AVG (Average) reading is calculated over time. Press the button momentarily to read the MAX, MIN and AVG readings in sequence. Press the button for 1 second or more to exit MAX/MIN/AVG recording mode.

***Note:**

When activated, nominal measurement speed and manual/auto-ranging selection remains, and Auto-Power-Off is disabled automatically. Main display readings are used for MAX/MIN Comparison and AVG calculation. Secondary display is the accompanied significant readings where available. In 500,000 count mode, lower resolution 50,000 count mode will be used instead.

1ms CREST capture mode

Press **CREST** button momentarily to activate CREST (Instantaneous Peak-Hold) mode to capture voltage or current signal duration as short as 1ms. It is available to main display 5000uA, 500mA, 10A and voltage function ranges. The LCD “C” & “MAX” turn on. The meter beeps when new MAX (maximum) or MIN (minimum) reading is updated. Press the button momentarily to read the MAX and MIN readings in sequence. Press the button for 1 second or more to exit CREST mode. Voltage manual/auto-ranging (up range) remains, and Auto-Power-Off is disabled automatically in this mode.

Backlight display

Press the **SELECT** button for 1 second or more to toggle the LCD backlight. The backlight will also be turned off automatically after approximate 32 seconds to extend battery life.

500000 count mode

Press the **500000** (Δ) button for 1 second or more to toggle the 50000/500000 count mode. It is available to single display DC Voltage function ranges. Measuring speed is reduced to 1.25 times per second.

Beep-Jack™ Input Warning

The meter beeps as well as displays “InEr” to warn the user against possible damage to the meter due to improper connections to the μA , mA, or A input jacks when other function (like voltage function) is selected.

Hold

The hold feature freezes the display for later view. Press the **HOLD** button momentarily to toggle the hold feature.

△ Relative Zero mode

Press the Δ button momentarily to toggle relative zero mode. It allows the user to offset the meter consecutive measurements with the displaying reading as the reference value in the main display. Practically all displaying readings in the main display can be activated as relative reference values including MAX/MIN/AVG readings.

Manual or Auto-ranging

Press the **RANGE** button momentarily to select manual-ranging, and the meter will remain in the range it was in, the LCD **AUTO** turns off. Press the button momentarily again to select an adjacent range. Press and hold the button for 1 second or more to resume auto-ranging.

Note: Manual ranging feature is not available in Hz function. Hz Sensitivity will be changed instead where available.

Set Beeper Off

Press the **RANGE** button while turning the meter on to temporarily disable the Beeper feature. Turn the rotary switch OFF and then back on to resume.

Auto-Power-off (APO)

The Auto-Power-off (APO) mode turns the meter off automatically to extend battery life after approximately 17 minutes of no activities. Activities are specified as: 1) Rotary switch or push button operations, and 2) Significant measuring readings of above 9% of range or non-OL Ω readings. In other words, the meter will intelligently avoid entering the APO mode when it is under normal measurements.. To wake up the meter from APO, press the **SELECT, RANGE, RELATIVE or HOLD** button momentarily or turn the rotary switch OFF and then back on. Always turn the rotary switch to the OFF position when the meter is not in use.

Disabling Auto-Power-off

Press the **SELECT** button while turning the meter on to temporarily disable the Auto-Power-Off feature. Turn the rotary switch OFF and then back on to resume.

5) MAINTENANCE

WARNING

To avoid electrical shock, disconnect the meter from any circuit, remove the test leads from the input jacks and turn OFF the meter before opening the case. Do not operate with open case. Install only the same type of fuse or equivalent

Calibration

Accuracy is specified for a period of one year after calibration. Periodic calibration at intervals of one year is recommended to maintain meter accuracy.

If self-diagnostic message “rE-O” is being displayed while powering on, the meter is re-organizing internal parameters. Do not switch off the meter, and it will be back to normal measurement shortly. However, if self-diagnostic message “C_Er” is being displayed while powering on, some meter ranges might be largely out of specifications. To avoid mis-leading measurements, stop using the meter and send it for re-calibration. Refer to the LIMITED WARRANTY section for obtaining warranty or repairing service.

Cleaning and Storage

Periodically wipe the case with a damp cloth and mild detergent; do not use abrasives or solvents. If the meter is not to be used for periods of longer than 60 days, remove the battery and store it separately

Trouble Shooting

If the instrument fails to operate, check battery, fuses, leads, etc., and replace as necessary. Double check operating procedure as described in this user’s manual

If the instrument voltage-resistance input terminal has subjected to high voltage transient (caused by lightning or switching surge to the system) by accident or abnormal conditions of operation, the series fusible resistors will be blown off (become high impedance) like fuses to protect the user and the instrument. Most measuring functions through this terminal will then be open circuit. The series fusible resistors and the spark-gaps (or varistors) should then be replaced by qualified technician. Refer to the LIMITED WARRANTY section for obtaining warranty or repairing service.

Battery and Fuse replacement

Battery use: Single 9V battery; NEDA1604G, JIS006P IEC6F22, NEDA1604A, JIS6AM6 or IEC6LF22

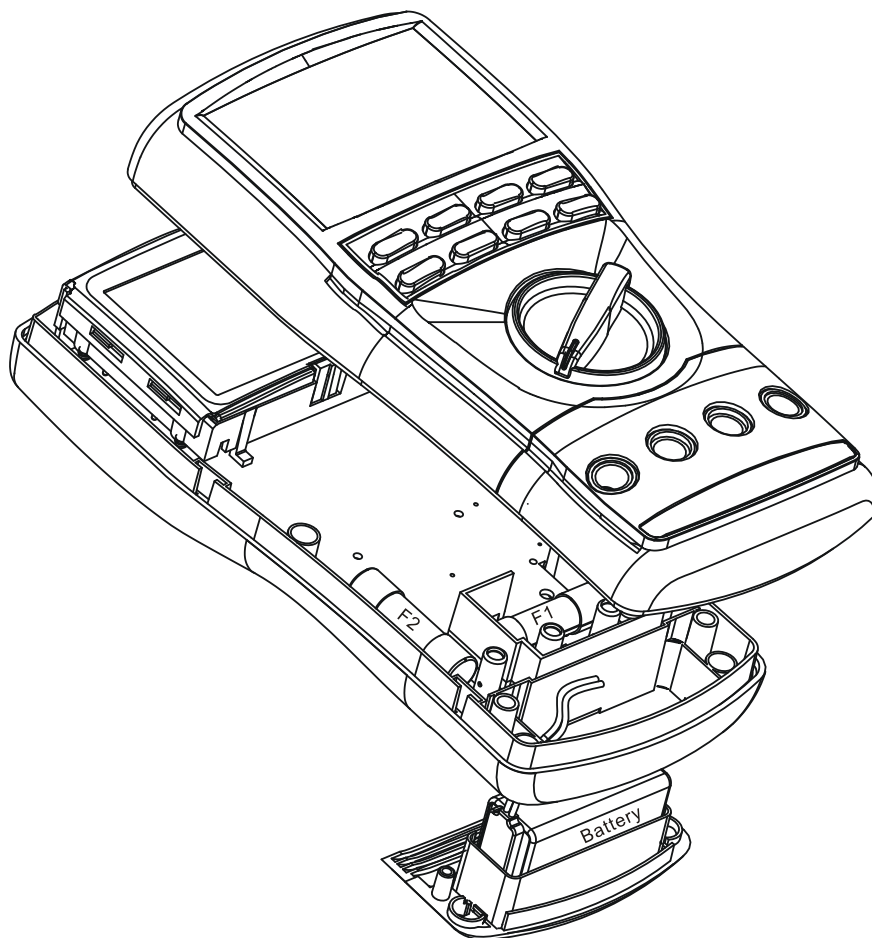

Fuses use:

Fuse (FS1) for μmA current input:

0.44A/1000Vac & Vdc, IR 10kA or better, F fuse; Dimension: 10 x 38 mm

Fuse (FS2) for A current input:

11A/1000Vac & Vdc, IR 20kA or better, F fuse; Dimension: 10 x 38 mm

Battery replacement:

Loosen the 2 screws from the battery access door of the case bottom. Lift the battery access door and thus the battery compartment up. Replace the battery. Re-fasten the screws.

Fuse replacement:

Loosen the 4 screws from the case bottom. Lift the end of the case bottom nearest the input jacks until it unsnaps from the case top. Replace the blown fuse(s). Replace the case bottom, and ensure that all the gaskets are properly seated and the two snaps on the case top (near the LCD side) are engaged. Re-fasten the screws.

GENERAL SPECIFICATION

Display: 4-4/5 digits 50,000 counts fast mode. Selectable stable mode 5-4/5 digits 500,000 counts for DC Voltage & 5 digits 99,999 counts for Hz

Polarity: Automatic

Update Rate:

4-4/5 digits fast mode: 5 per second nominal;

5-4/5 digits stable mode: 1.25 per second nominal;

41 Segments Bar graph: 60 per second max

Operating Temperature: 0°C to 45°C

Relative Humidity: Maximum relative humidity 80% for temperature up to 31°C decreasing linearly to 50% relative humidity at 45°C

Pollution degree: 2

Storage Temperature: -20°C to 60°C, < 80% R.H. (with battery removed)

Altitude: Operating below 2000m

Temperature Coefficient: nominal 0.15 x (specified accuracy)/ °C @ (0°C ~ 18°C or 28°C ~ 45°C), or otherwise specified

Sensing: AC, AC+DC True RMS

Safety: Double insulation per IEC/UL/EN61010-1 Ed. 3.0, IEC/EN61010-2-030 Ed. 1.0, IEC/EN61010-2-033 Ed. 1.0, IEC/UL/EN61010-031 Ed. 1.1 and CAN/CSA-C22.2 No. 61010-1-12 Ed. 3.0 to Category IV 1000V AC & DC

Terminals (to COM) Measurement Category:

V / A / mA μ A : Category IV 1000 Vac & Vdc

Overload Protections:

μ A & mA : 0.44A/1000V DC/AC rms, IR 10kA, F fuse

A : 11A/1000V DC/AC rms, IR 20kA, F fuse

V : 1100V DC/AC rms

mV, Ω & Others : 1000V DC/AC rms

Transient protection: 12kV (1.2/50 μ s surge)

E.M.C.: Meets EN61326-1:2006 (EN55022, EN61000-3-2, EN61000-3-3, EN61000-4-2, EN61000-4-3, EN61000-4-4, , EN61000-4-5, EN61000-4-6, EN61000-4-8, EN61000-4-11)

In an RF field of 3V/m:

Capacitance function is not specified

Other function ranges:

Total Accuracy = Specified Accuracy + 1000 digits

Performance above 3V/m is not specified

Power Supply: Single Alkaline 9V battery; NEDA1604A, JIS6AM6 or IEC6LF22

Power Consumption: 6.5mA typical; 8mA for VFD ranges (Model 869s only)

Low Battery: Below approx. 7V

APO Timing: Idle for 17 minutes

APO Consumption: 70 μ A typical .

Dimension: L208mm X W103mm X H64.5mm with holster

Weight: 635 gm with holster

Accessories: Test leads (pair), holster, battery installed, user's manual, Bkp60 banana plug K-type thermocouple x 1 (**Model 869s** only)

Optional Accessories: BU-86X PC interface kit, Bkb32 banana pins to K-type socket plug adapter (**Model 869s** only)

Special Features: Record MAX, MIN & AVG readings; Crest (Instantaneous Peak hold) MAX & MIN readings; Relative zero mode; 500,000 counts stable DCV mode; Paper-White Backlit display; dBm readings; %4-20mA loop current readings; Data Hold; BeepJack™ Audible & visible input warning; T1-T2 differential temperature readings (**Model 869s** only); VFD V & Hz readings (**Model 869s** only)

Electrical Specifications

Accuracy is \pm (% reading digits + number of digits) or otherwise specified, at 23°C \pm 5°C & less than 75% relative humidity.

True RMS voltage & current accuracies are specified from 5 % to 100 % of range or otherwise specified. Maximum Crest Factor < 2.1:1 at full scale & < 4.2:1 at half scale, and with frequency components within the specified frequency bandwidth for non-sinusoidal waveforms.

DC Voltage

RANGE	869s	867s
Accuracy		
500.00mV, 5.0000V,	0.02% + 2d	0.03% + 2d
50.000V	0.03% + 2d	0.04% + 2d
500.00V	0.04% + 2d	0.05% + 2d
1000.0V	0.15% + 2d	0.15% + 2d

Input Impedance: 10M Ω , 60pF nominal
(80pF nominal for 500mV range)

Ohms

RANGE	869s	867s
Accuracy		
500.00 Ω	0.07%+10d	0.1%+10d
5.0000k Ω	0.07%+2d	0.1%+6d
50.000k Ω	0.1%+2d	0.1%+6d
500.00k Ω	0.1%+2d	0.1%+6d
5.0000M Ω	0.3%+6d	0.4%+6d
50.000M Ω	2.0%+6d	2.0%+6d
99.99nS*	2.0%+10d	2.0%+10d

Open Circuit Voltage: < 1.3VDC (< 3VDC
for 500 Ω range)

*From 0% to 10% of range: Specified
accuracy + 30d

Audible Continuity Tester

Audible threshold: between 20 Ω and 200 Ω
Response time < 100 μ s

Crest mode (Instantaneous Peak Hold)

Resolution: 5000 counts

Accuracy: Specified accuracy \pm 100 digits
for changes > 0.8ms in duration

AC Voltage

RANGE	869s	867s	
Accuracy *			
20Hz ~ 45Hz			
500.00mV, 5.0000V, 50.000V	1.2% + 40d	Unspec'd	
500.00V, 1000.0V	Unspec'd		
45Hz ~ 300Hz			
500.00mV	0.3% + 20d	0.8%+60d	
5.0000V, 50.000V	0.4% + 30d		
500.00V, 1000.0V	0.5% + 40d		
		300Hz ~ 5kHz	300Hz ~ 1kHz
500.00mV	0.3% + 20d	0.8%+40d	
5.0000V, 50.000V, 500.00V	0.4% + 40d	2.0%+60d	
1000.0V	0.8% + 40d**	1.0%+40d	
		5kHz ~ 20kHz	1kHz ~ 20kHz
500.00mV	0.5%+30d	1dB***	
5.0000V, 50.000V	0.7%+40d	2dB***	
500.00V	0.5%+40d	3dB***	
1000.0V	Unspec'd	Unspec'd	
20kHz ~ 100kHz			
500.00mV	2.5%+40d	Unspec'd	
5.0000V, 50.000V	4.0%+40d***		
500.00V	Unspec'd		
1000.0V			

*From 5% to 10% of range: Specified
accuracy + 80d

**Specified bandwidth 300Hz ~ 1kHz

***From 5% to 10% of range: Specified
accuracy + 180d

From 10% to 15% of range: Specified

accuracy + 100d

Input Impedance: 10M Ω , 60pF nominal
(80pF nominal for 500mV range)

Residual reading less than 50 digits with
test leads shorted.

DC^{AC} & AC+DC^{AC} Voltage

RANGE	869s	867s
Accuracy *		
20Hz ~ 45Hz		
500.00mV, 5.0000V, 50.000V	1.5% + 40d	Unspec'd
500.00V, 1000.0V	Unspec'd	
DC, 45Hz ~ 300Hz		
500.00mV	0.45% + 40d	0.8%+60d
5.0000V, 50.000V	0.7% + 80d	
500.00V, 1000.0V	0.7% + 40d	
	300Hz ~ 5kHz	300Hz ~ 1kHz
500.00mV	0.8% + 40d	0.8%+40d
5.0000V, 50.000V, 500.00V	0.8% + 40d	2.0%+60d
1000.0V	1.0% + 40d**	1.0%+40d
	5kHz ~ 20kHz	1kHz ~ 20kHz
500.00mV	1.0%+40d	1dB***
5.0000V, 50.000V	1.5%+40d	2dB***
500.00V	1.5%+40d	3dB***
1000.0V	Unspec'd	Unspec'd
20kHz ~ 40kHz		
500.00mV	3.5%+40d	Unspec'd
5.0000V, 50.000V	4.0%+40d***	
500.00V 1000.0V	Unspec'd	

*From 5% to 10% of range: Specified
accuracy + 80d

**Specified bandwidth 300Hz ~ 1kHz

***From 5% to 10% of range: Specified
accuracy + 180d

From 10% to 15% of range: Specified
accuracy + 100d

Input Impedance: 10M Ω , 60pF nominal
(80pF nominal for 500mV range)

Residual reading less than 50 digits with
test leads shorted.

VFD AC Voltage (Model 869s only)

RANGE	Accuracy*
5Hz ~ 20Hz	
5.0000V, 50.000V, 500.00V, 1000.0V	3% + 80d
20Hz ~ 200Hz	
5.0000V, 50.000V, 500.00V, 1000.0V	2% + 50d
200Hz ~ 440Hz	
5.0000V, 50.000V, 500.00V, 1000.0V	6% + 80d**

*Not specified for fundamental frequency >
440Hz

**Accuracy linearly decreases from 2% +
50d @ 200Hz to 6% + 80d @ 440Hz

dBm

Range and accuracy are subjected to
ACmV, ACV, and reference impedance
selected. Typical 600 Ω reference
impedance ranges:

At ACmV : -29.83dBm to -03.80dBm

At ACV : -01.09dBm to 62.22dBm

Input Impedance: 10M Ω , 60pF nominal

Selectable reference impedance of 4, 8,
16, 32, 50, 75, 93, 110, 125, 135, 150, 200,

250, 300, 500, 600, 800, 900, 1000 & 1200Ω

Diode Tester

Range	Accuracy	Test Current (Typical)	Open Circuit Voltage
2.0000V	1%+1d	0.4mA	< 3.5 VDC

Capacitance

RANGE	Accuracy*
50.00nF	0.8% + 3d
500.0nF	0.8% + 3d
5.000μF	1.5% + 3d
50.00μF	2.5% + 3d
500.0μF**	3.5% + 5d
5.000mF**	5.0% + 5d
25.00mF**	6.5% + 5d

*Accuracies with film capacitor or better

**In manual-ranging mode, measurements not specified below

45.0μF/0.450mF/4.50mF (450 counts) for 500.0μF/5.000mF/25.00mF ranges respectively

DC Loop Current %4~20mA

4mA = 0% (zero); 20mA = 100% (span)

Resolution: 0.01% Accuracy: ± 25d

DC Current

RANGE	Accuracy	Burden Voltage
500.00μA	0.15%+20d	0.15mV/μA
5000.0μA	0.1%+20d	0.15mV/μA
50.000mA	0.15%+20d	3.3mV/mA
500.00mA	0.15%+30d	3.3mV/mA
5.0000A	0.5%+20d	45mV/A
10.000A*	0.5%+20d	45mV/A

*10A continuous, >10A to 20A for 30 second max with 5 minutes cool down interval

AC, DC^{AC} & AC+DC^{AC} Current

RANGE	869s	867s	Burden Voltage
	Accuracy		
DC, 50Hz ~ 60Hz			
500.00μA	0.5% + 50d	1.0% + 40d	0.15mV/μA
5000.0μA			0.15mV/μA
50.000mA			3.3mV/mA
500.00mA			3.3mV/mA
5.0000A			45mV/A
10.000A*			45mV/A
40Hz ~ 1kHz			
500.00μA	0.7% + 50d	1.0% + 40d	0.15mV/μA
5000.0μA			0.15mV/μA
50.000mA			3.3mV/mA
500.00mA			3.3mV/mA
5.0000A			45mV/A
10.000A*			45mV/A
1kHz ~ 20kHz			
500.00μA	2.0% + 50d	Unspec'd	0.15mV/μA
5000.0μA			0.15mV/μA
50.000mA			3.3mV/mA
500.00mA			3.3mV/mA
5.0000A	Unspec'd	Unspec'd	45mV/A
10.000A*			
20kHz ~ 100kHz			
500.00μA	5.0% + 50d	Unspec'd	0.15mV/μA
5000.0μA			0.15mV/μA
50.000mA			3.3mV/mA
500.00mA			3.3mV/mA
5.0000A	Unspec'd	Unspec'd	45mV/A
10.000A*			

*10A continuous, >10A to 20A for 30 second max with 5 minutes cool down interval

~ Hz Line Level Frequency

AC Function RANGE	Sensitivity (Sine RMS)	Range
500mV	100mV	10Hz ~ 200kHz
5V	0.6V	10Hz ~ 100kHz
50V	6V	10Hz ~ 100kHz
500V	50V	10Hz ~ 100kHz
1000V	500V	10Hz ~ 10kHz
VFD 5V	0.5V ~ 2V*	10Hz ~ 440Hz
VFD 50V	5V ~ 20V*	10Hz ~ 440Hz
VFD 500V	50V ~ 200V*	10Hz ~ 440Hz
500 μ A	50 μ A	10Hz ~ 10kHz
5000 μ A	500 μ A	10Hz ~ 10kHz
50mA	5mA	10Hz ~ 10kHz
500mA	50mA	10Hz ~ 10kHz
5A	1A	10Hz ~ 3kHz
10A	10A	10Hz ~ 3kHz

Accuracy: 0.02%+4d

*VFD sensitivity linearly decreases from 10% F.S. @ 200Hz to 40% F.S. @ 440Hz

Hz Logic Level Frequency

RANGE	Accuracy
5.000Hz ~ 1.0000MHz	0.002%+4d

Sensitivity: 2.5Vp square wave

%Duty Cycle

RANGE	Accuracy
0.1% ~ 99.99%	3d/kHz+2d

Input Frequency: 5Hz -- 500 kHz, 5V Logic Family

T1-T2 Type-K Temperature (Model 869s only)

RANGE	Accuracy
-50.0°C to 1000.0°C	0.3%+1.5°C
-58.0°F to 1832.0°F	0.3%+3.0°F

Type-K thermocouple range & accuracy not included

NOTE

LIMITED WARRANTY

BRYMEN warrants to the original product purchaser that each product it manufactures will be free from defects in material and workmanship under normal use and service within a period of one year from the date of purchase. BRYMEN's warranty does not apply to accessories, fuses, fusible resistors, spark gaps, batteries or any product which, in BRYMEN's opinion, has been misused, altered, neglected, or damaged by accident or abnormal conditions of operation or handling.

To obtain warranty service, contact your nearest BRYMEN authorized agent or send the product, with proof of purchase and description of the difficulty, postage and insurance prepaid, to BRYMEN TECHNOLOGY CORPORATION. BRYMEN assumes no risk for damage in transit. BRYMEN will, at its option, repair or replace the defective product free of charge. However, if BRYMEN determines that the failure was caused by misused, altered, neglected, or damaged by accident or abnormal conditions of operation or handling, you will be billed for the repair.

THIS WARRANTY IS EXCLUSIVE AND IS IN LIEU OF ALL OTHER WARRANTIES, EXPRESSED OR IMPLIED, INCLUDING BUT NOT LIMITED TO ANY IMPLIED WARRANTY OR MERCHANTABILITY OR FITNESS FOR A PARTICULAR PURPOSE OR USE. BRYMEN WILL NOT BE LIABLE FOR ANY SPECIAL, INDIRECT, INCIDENTAL OR CONSEQUENTIAL DAMAGES.



BRYMEN TECHNOLOGY CORPORATION

TEL:+886 2 2226 3396

FAX:+886 2 2225 0025

<http://www.brymen.com>



PRINTED ON RECYCLABLE PAPER, PLEASE RECYCLE

COPYRIGHT © MMXIII BTC,

ALL RIGHTS RESERVED

P/N: 7M1C-1311-0000

PRINTED IN TAIWAN