







ENGLISH

User manual



Table of contents:

1	PRECAUTIONS AND SAFETY MEASURES	2
1.1	During use	2
1.2	After use	2
2	GENERAL DESCRIPTION	3
3	PREPARATION FOR USE	4
3.1	Initial checks	4
3.2	Instrument power supply	4
3.3	Calibration	4
3.4	Storage	4
4	NOMENCLATURE	5
4.1	Instrument description	5
4.2	Description of function keys	8
4.2.1	Switching on/off the instrument	8
4.2.2	Keys  e 	8
4.2.3	Key 	8
4.2.4	Key 	8
4.2.5	Key 	8
4.2.6	Keys 	8
4.2.7	T key (Trigger)	8
5	OPERATING INSTRUCTIONS	9
5.1	Description of the main interface	9
5.1.1	Image focusing	9
5.1.2	Image zoom	10
5.1.3	Adjusting the distance of the object in Fusion screens	10
5.2	General menu description	11
5.2.1	Settings Menu	12
5.2.2	Measurement Menu	17
5.2.3	Emissivity menu	18
5.2.4	Image menu	20
5.2.5	Palette Menu	21
5.2.6	“Range” Menu	21
5.2.7	Image adjustment	22
5.3	Saving the image on the display	23
5.4	Recording a video on the display	23
5.5	Recalling and deleting displayed images and videos	24
5.5.1	Playback of videos on the display	25
5.6	Using the instrument	26
5.7	Transferring images/videos onto the PC	28
5.7.1	Displaying an image on the PC in real time	29
5.8	HDMI video output	29
6	USING THE THTLINK SOFTWARE	30
6.1	Minimum system requirements	30
6.2	Installing the THTLink software	30
6.3	Main characteristics of the THTLink software	30
7	MAINTENANCE	31
7.1	General information	31
7.2	Recharging the internal battery	31
7.3	Cleaning the instrument	31
7.4	End of life	31
7.5	Accessories	32
7.5.1	Accessories provided	32
8	TECHNICAL SPECIFICATIONS	33
8.1	Environment	33
8.1.1	Environmental conditions for use	33
9	SERVICE	34
9.1	Warranty conditions	34
9.2	Service	34

1 PRECAUTIONS AND SAFETY MEASURES

In the whole manual, the word “instrument” generically indicates models **THT45** and **THT46**, unless otherwise indicated. The instrument has been designed in compliance with the directives relevant to electronic measuring instruments. For your safety and in order to prevent damaging the instrument, please carefully follow the procedures described in this manual and read all notes preceded by the symbol  with the utmost attention. Before and after carrying out the measurements, carefully observe the following instructions:



CAUTION

- Do not carry out any measurements in case gas, explosive materials or flammables are present, or in humid or dusty environments.
- Do not carry out any measurement in case you find anomalies in the instrument such as deformation, breaks, substance leaks, absence of display on the screen, etc.
- Keep the instrument steady during any measuring operation.
- Do not carry out any measurements which exceed the working and storage temperature ranges specified in § 8.1.1.
- Only the accessories provided together with the instrument will guarantee safety standards. They must be used only if in good conditions and replaced with identical models, when necessary.
- Check that the battery is correctly inserted.
- Check that the LCD display gives indications consistent with the function selected.
- Do not direct the instrument at very high intensity radiation sources (e.g. the sun) in order to prevent damaging the IR sensor.
- Prevent hits or strong vibrations in order to keep the instrument from damage.
- When bringing the instrument from a cold to a hot environment, leave it on long enough for condensation water to evaporate.

In this manual, and on the instrument, the following symbols are used:



CAUTION: observe the instructions given in this manual; improper use could damage the instrument or its components.



This symbol on the display means that the instrument is able to emit a laser pointer in Class 2. **Do not direct the radiation towards the eyes in order to prevent physical damage to people.**



Compliant with European Standards

1.1 DURING USE



CAUTION

- Failure to comply with the caution notes and/or instructions may damage the instrument or be a source of danger for the operator.
- Use the instrument only in the temperature ranges indicated in § 8.1.1

1.2 AFTER USE

When measurement is complete, switch off the instrument. If you expect not to use the instrument for a long period, remove the battery.

2 GENERAL DESCRIPTION

The instrument is a digital thermal camera capable of carrying out infrared temperature measurements of objects and providing thermographic images. It is also very easy to use and needs little maintenance.

The main characteristics of the instrument are:

- Infrared temperature measurement ranging from -20°C to 350°C
- Built-in photo camera for a visual image
- PiP fusion function
- 3 selectable measuring cursors
- Table with emissivity values of common material
- 4 standard colour palettes
- Electronic zoom x1-x32
- Automatic detection of hot/cold spots of the image
- Storage of JPG images on external micro SD card
- IR sensor resolution: 80x80pxl (THT45), 160x120pxl (THT46)
- USB port for PC connection and image transfer
- MPEG4 video recording on micro SD card
- Video and microphone output
- Built-in laser pointer and illuminator
- Rechargeable Li-ION battery
- Analysis and printing of images with the dedicated software provided

The applications of the digital thermal camera are:

- Predictive and preventive maintenance of the electrical and mechanical appliances
- Monitoring of the temperature of working processes
- Maintenance and troubleshooting on forced ventilation ducts
- Domestic/industrial use in troubleshooting environmental insulation problems
- Safety problems

3 PREPARATION FOR USE

3.1 INITIAL CHECKS

Before shipping, the instrument has been checked from an electric as well as mechanical point of view. All possible precautions have been taken so that it is delivered undamaged.

However, we recommend generally checking the instrument in order to detect possible damage suffered during transport. In case anomalies are found, immediately contact the forwarding agent.

We also recommend checking that the packaging contains all components indicated in § 7.5. In case of discrepancy, please contact the Dealer. In case the instrument should be replaced, please carefully follow the instructions given in §. 9

3.2 INSTRUMENT POWER SUPPLY

The instrument is supplied by a 1x3.7V rechargeable Li-ION battery and AC mains power supply, which also provides for the recharge of the mentioned battery. Both of these systems are provided together with the instrument. For battery recharge, please refer to § 7.2.

3.3 CALIBRATION

The instrument has the technical specifications described in this manual. The instruments performance is guaranteed for one year.

3.4 STORAGE

In order to guarantee precise measurement, after a long storage time under extreme environmental conditions, wait for the instrument to come back to normal condition (see § 8.1.1).

4 NOMENCLATURE

4.1 INSTRUMENT DESCRIPTION

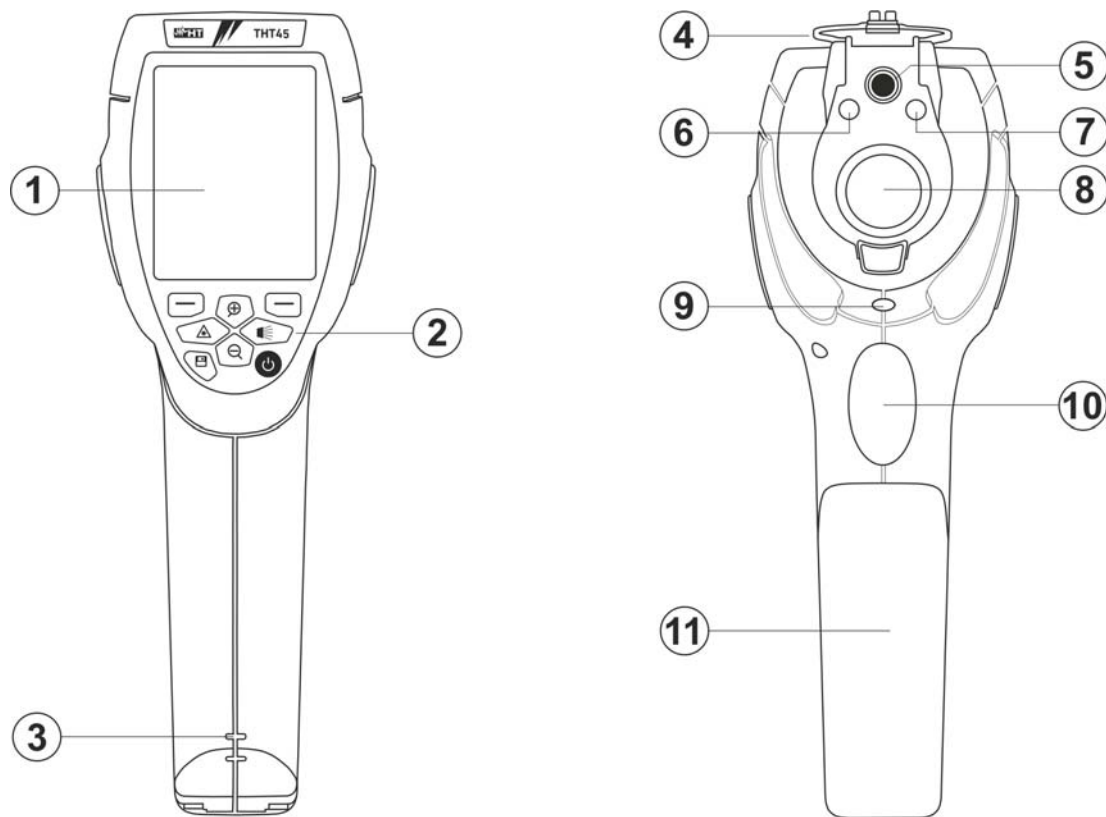



Fig. 1: Description of the instrument's front and backside

CAPTION:

1	LCD display
2	Function keys 
3	Holes for non-slip strap
4	Lens protection cap
5	In-built visual photo camera
6	Laser pointer
7	Built-in illuminator
8	Lens associated with the IR sensor
9	Hole for tripod insertion
10	Trigger key (T)
11	Battery compartment cover

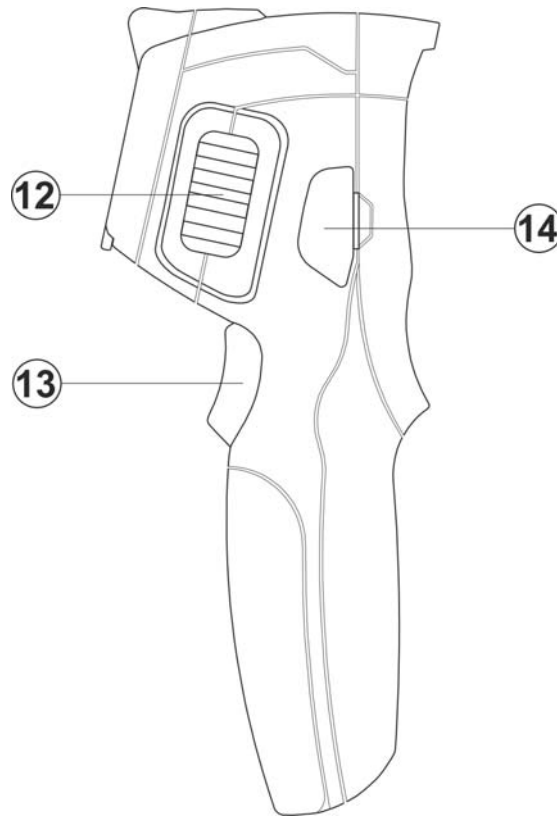

Fig. 2: Description of the instruments side

CAPTION:

12	Lens focus adjuster
13	Trigger key (T)
14	Instrument's inputs and outputs location

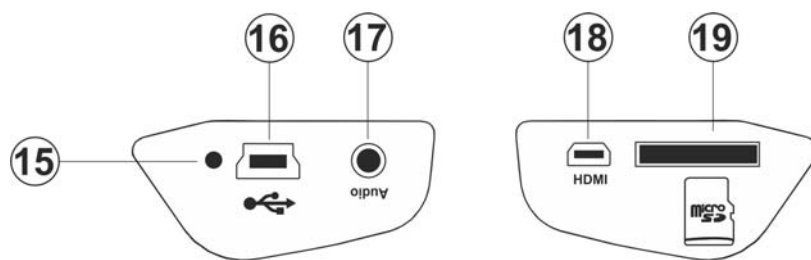

Fig. 3: Description of the instrument's inputs and outputs

CAPTION:

15	Battery charge indicator LED
16	Input for connecting AC adapter/battery charger and USB port
17	Audio input for connecting microphone/headphones
18	HDMI video output
19	Input for micro SD card

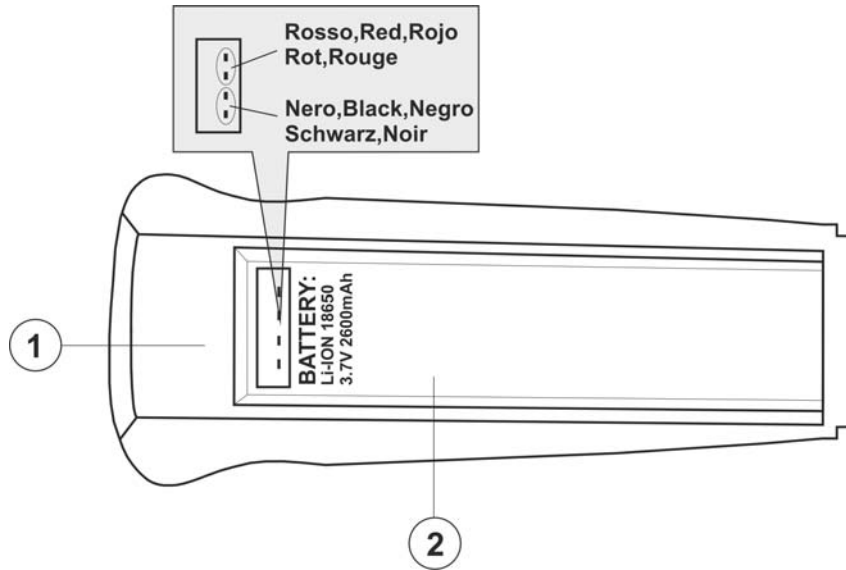









Fig. 4: Description of the instrument's battery compartment



CAPTION:

1	Inside of the battery compartment
2	Battery insertion section

4.2 DESCRIPTION OF FUNCTION KEYS

The instrument has 8 function keys indicated as , , , , , ,  and a trigger key "T" with multiple functions.

4.2.1 Switching on/off the instrument



Press the  button to switch on the instrument. After approx. 10 seconds internal autotest, the instrument shows its normal measuring screen. To switch off the instrument, press and hold the  key for 2 seconds.

CAUTION



A simple pressing of the  key activates the manual calibration of the instrument, which is necessary if the IR image is out of focus or if you frame a new subject. The message "Calibration..." is shown on the display for some seconds.

4.2.2 Keys e

By pressing the keys  or  you can respectively Zoom in or out the image on the display (see § 5.1.2). The same keys are also used for the selection of system parameters.

4.2.3 Key

Pressing and hold the key  allows activating/deactivating the internal illuminator (see Fig. 1 – Part 6). The same key is also used for the selection of system parameters.

4.2.4 Key

Pressing and hold the key  allows activating/deactivating the laser pointer (see Fig. 1 – Part 7). The same key is also used for the selection of system parameters.

4.2.5 Key

Press the key  to access/exit the gallery of images (JPG files) or videos (MP4 files) available on the micro SD card inserted in the instrument (see § 5.3).

4.2.6 Keys

The keys  are used when programming the instrument respectively to enable a selection of a parameter or to exit and go back to the main screen. With these keys, you can also select the adjusting mode of the image between Automatic and Manual (see § 5.2.7).

4.2.7 T key (Trigger)

Pressing the **T** key found in the front part of the instrument allows saving the image shown on the display on the micro SD card (see § 5.3). Long pressing the **T** key allows automatically activating a video (see § 5.4).

5 OPERATING INSTRUCTIONS

5.1 DESCRIPTION OF THE MAIN INTERFACE

The instrument shows the following main interface on the display:

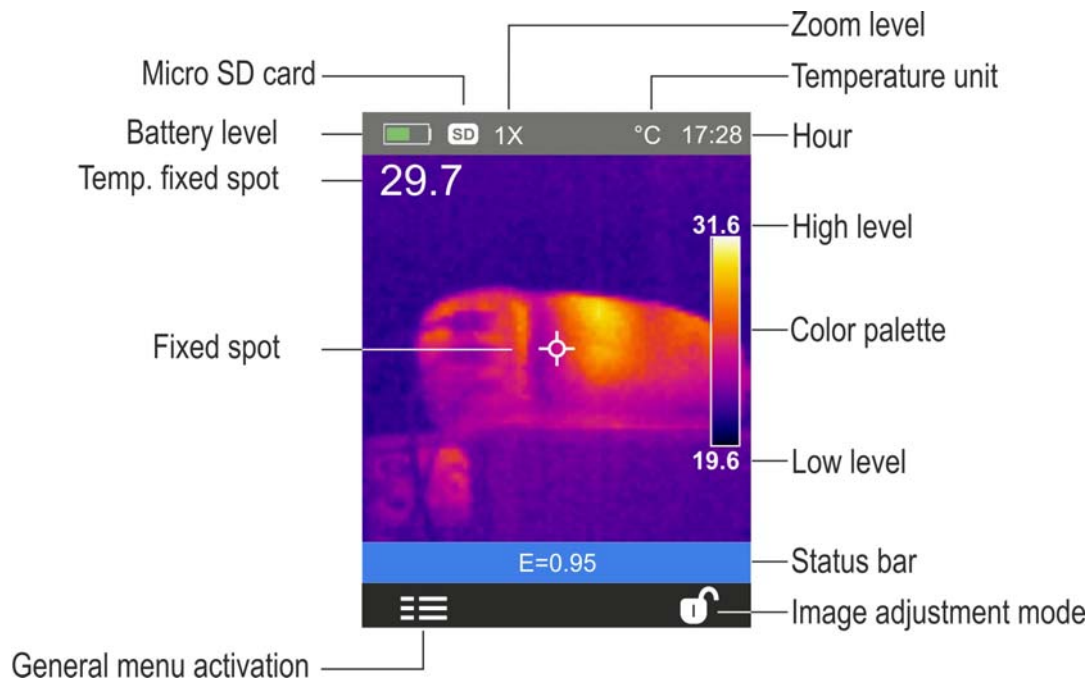

Fig. 5: Main instrument interface

The meaning of the symbols found on the display is described below.

Symbol	Description
	Micro SD card inside the instrument
E=0.95	Set value of object emissivity
°C	Indication of the temperature measuring unit
	Access to the functions of the main menu
1X	Indication of the Zoom percentage (x1 ÷ x32)
	Battery charge level indication (see § 7.2)
17.28	Indication of the system's current time
Level	Indication of temperature levels of the IR image (see § 5.2.7)
Palette	Indication of colour palette (see § 5.2.5)
	Image adjusting mode setting (see § 5.2.7)

5.1.1 Image focusing

Focusing the IR image found on the instrument's display must be performed manually by rotating the adjuster installed on the front part (see Fig. 2 - Pos. 12). Keep the instrument steady while performing this operation.



CAUTION

Always focus the image before saving it, in order to perform correct temperature measurements of the framed object.

5.1.2 Image zoom

The instrument is provided with an electronic digital zooming function of the IR image and of the framed visual image. To use this function, proceed as follows:

1. Frame the object to be tested (see Fig. 6 – Left side) and press the key \oplus as many times as you want to zoom the image. Each pressing increases the size of the image by 10% with respect to the original. The instrument show the zoom value on the top side of the display (see Fig. 6 – Right side relevant to x10 zoom). Possible options are: **1x ÷ 32x**

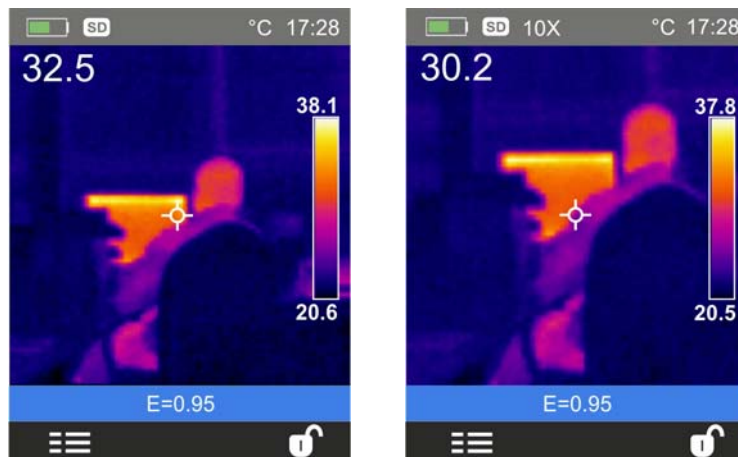

Fig. 6: Setting image zoom

2. Press the key \ominus to zoom out until you go back to the original image.

5.1.3 Adjusting the distance of the object in Fusion screens

In “**Fusion**” display mode (see § 5.2.4), due to the different position of the lens and of the built-in photo camera, when the object is close to the lens, the visible image tends to become bigger, while the IR image tends to reduce. When the object is more than 2m far from the lens, this effect tends to disappear. The instrument allows setting the distance of the object in order to compensate the effect at distances shorter than 2m. Proceed as follows:

1. Select the item “**Alignment**” within the **Setting** menu (see § 5.2.1).
2. Use the key $\left[\begin{smallmatrix} \text{---} \\ \text{---} \\ \text{---} \end{smallmatrix} \right]$ and then the keys \oplus or \ominus to set the value of the distance of the lens from the object. The following values are available: **0.5m, 1m, 1.5m** and **>2m**
3. Press the key “Select” to confirm or “Close” to exit without saving.

5.2 GENERAL MENU DESCRIPTION

By pressing the key , the instrument shows the following general menu, which allows accessing the internal functions:

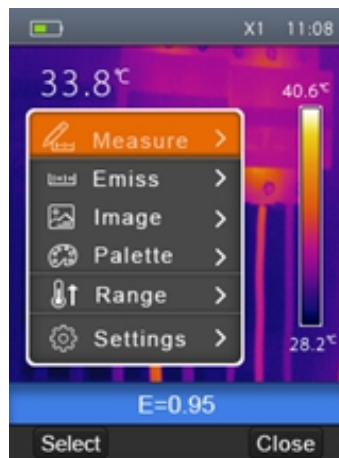

Fig. 7: Instrument general menu

Measure menu → defines the selection of the cursors which can be used while measuring (max 3 cursors)

Emiss menu → defines the setting of the emissivity of the object

Image menu → defines the display modes of the image

Palette menu → defines the selection of the type of palette which can be used on the instrument

Range menu → defines the instrument's measuring range of temperature

Settings menu → allows setting system parameters.

5.2.1 Settings Menu

By selecting “Settings” with the keys \oplus or \ominus and pressing the “Select” key or the key \triangle , the instrument enters the submenu in which you can define the values of system parameters.

“Language” section

1. Select the item “Language” with the keys \oplus or \ominus and press the key \equiv . The screen Fig. 8 – Right side is shown on the display.



Fig. 8: System language setting

2. Use the \oplus or \ominus keys to select the desired language among the ones available.
3. Press the key “Select” to confirm or “Close” to exit without saving.

Section “Temp Unit”

In this section it is possible to define the temperature measuring unit used by the instrument.

1. Select the item “Temp Unit” with the keys \oplus or \ominus and press the key \equiv . The screen Fig. 9 is shown on the display.



Fig. 9: Setting the temperature measuring unit

2. Use the keys \oplus or \ominus to select the measuring unit among the options; **°C**, **°F** or **°K**
3. Press the key “Select” to confirm or “Close” to exit without saving.

Section “Factory Set”

In this section it is possible to restore the default conditions of the instrument's parameters.

1. Select the item “Factory Set” with the keys \oplus or \ominus and press the key $\left[\right]$. The screen of Fig. 10 – Right side is shown on the display.

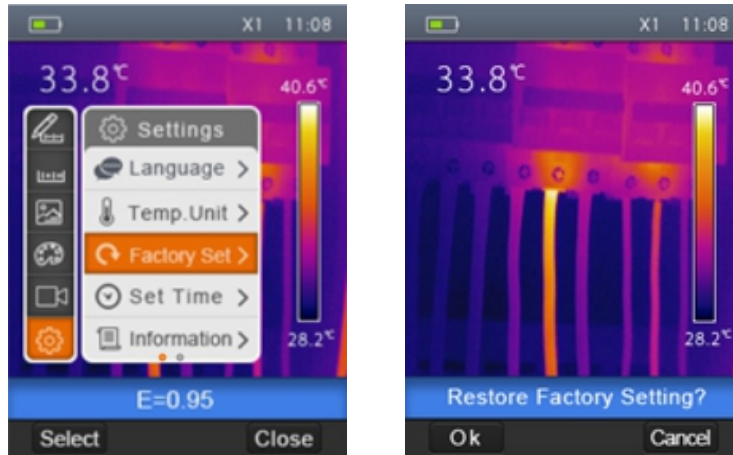

Fig. 10: Setting default conditions on the instrument

2. Press the key “Select” to restore the default conditions (see Table 1) or “Close” to cancel the operation.

Parameter	Default setting
Cursor in the middle of the display	On
Max temperature measurement cursor	Off
Min temperature measurement cursor	Off
Emissivity	0.95
Reflected temperature	25°C
Image display	IR
Colour palette	Iron
Temperature setting mode	Auto
Language	English

Table 1: Default conditions of the instrument

“Set Time” section

In this section it is possible to set the system date/time.

1. Select the item “ Set Time” with the keys \oplus or \ominus and press the key . The screen Fig. 11 – Right side is shown on the display.



Fig. 11: Setting the instrument's date/time

2. Use the keys or to select the desired formats of date and time
3. Use the keys \oplus or \ominus to set the desired values of date and time
4. Press the key “Ok” to confirm or “Cancel” to exit without saving.

“Information” section

This section contains general information about the instrument.

1. Select the item “Information” with the keys \oplus or \ominus and press the key . The screen Fig. 12 – Right side is shown on the display.



Fig. 12: Instrument information display

2. The information (model, serial number, Firmware internal version, last calibration date, residual memory on the micro SD card) are shown on the display.
3. Press the “Close” key to exit and to go back to the previous screen.

“Alignment” section

In this section it is possible to define the distance between the lens and the object which the instrument considers for “Fusion” display (see § 5.1.3).

1. Select the item “Alignment” with the keys \oplus or \ominus and press the key \equiv . The screen of Fig. 13 – Right side is shown on the display.

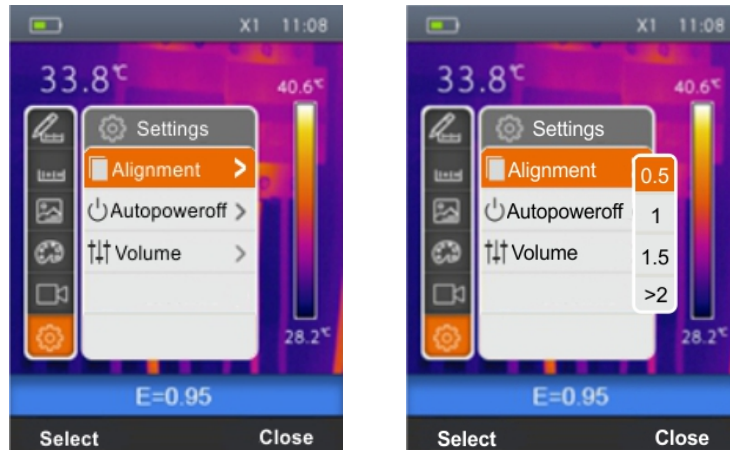

Fig. 13: Setting the alignment distance

2. Use the keys \oplus or \ominus to select the distance among the options; **0.5m, 1m, 1.5m** or **>2m**
3. Press the key “Select” to confirm or “Close” to exit without saving.

“Auto power off” section

In this section it is possible to enable/disable and adjust the auto power-off time of the instrument after a period of inactivity.

1. Select the item “Auto power-off” using the keys \oplus or \ominus and press the key \equiv . The screen Fig. 14 – Right side is shown on the display

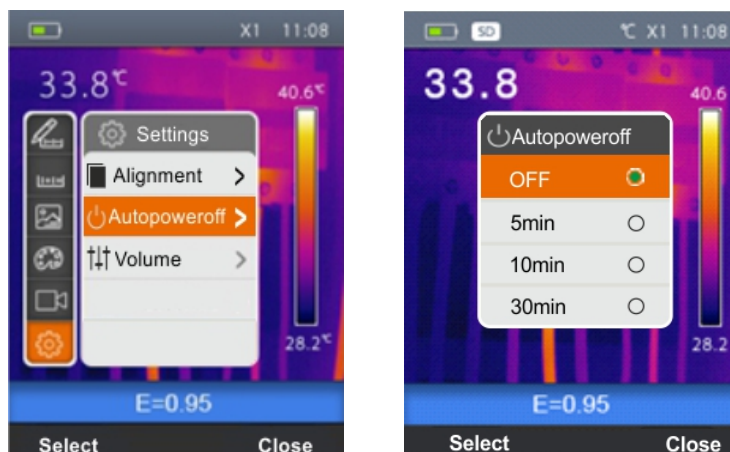





Fig. 14: Setting the alignment distance

2. Use the keys \oplus or \ominus to select the auto power-off time among the options; **OFF, 5min, 10min** or **30min**
3. Press the key “Select” to confirm or “Close” to exit without saving.

“Volume” section

In this section it is possible to enable/disable and adjust the volume associated with the playback of the videos recorded using the instrument (see § 5.5.1).

1. Select the item “Volume” using the keys  or  and press the key . The screen Fig. 15 – Right side is shown on the display

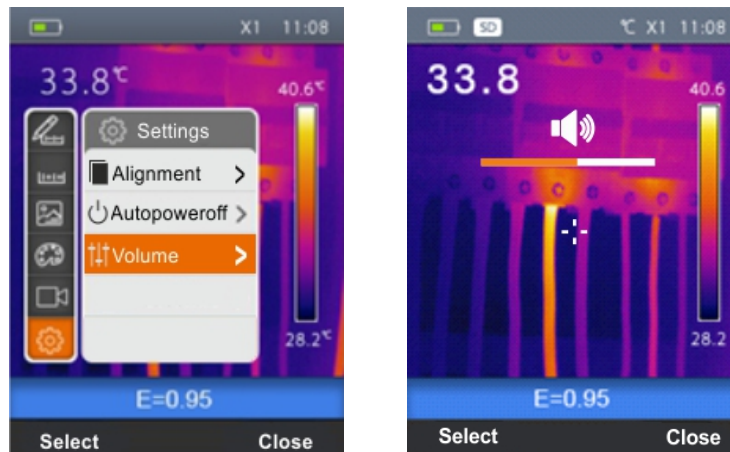



Fig. 15: Volume level setting

2. Use the keys  or  to set the volume level, possibly wearing the provided set of headphones.
3. Press the key “Select” to confirm or “Close” to exit without saving.

5.2.2 Measurement Menu

In this section it is possible to select/deselect the display of the three available measuring cursors independently. The thermal camera has:

- 1 steady cursor (point) in the middle of the display
- 1 dynamic cursor which identifies the temperature of the hottest spot of the image
- 1 dynamic cursor which identifies the temperature of the coldest spot of the image

1. Select the item “Measurement” with the keys \oplus or \ominus and press the key . The screen Fig. 16 – Right side is shown on the display.

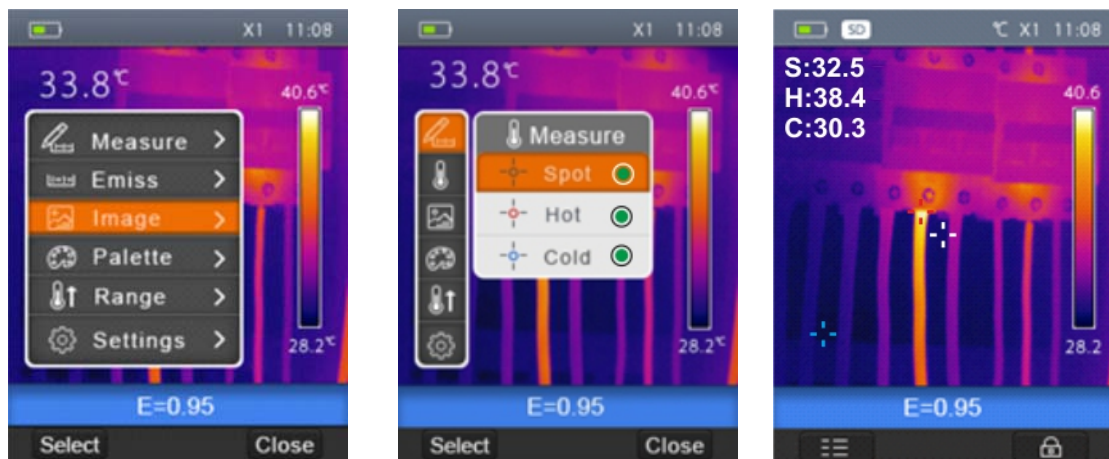

Fig. 16: Setting of measuring cursors

2. Use the keys \oplus or \ominus and press and hold the key “Select” or the key to select/deselect the desired measuring cursors among the options: **Spot** (steady white cursor, marked by the letter “S”), **Hot** (max value red cursor, marked by the letter “H”), **Cold** (min value blue cursor, marked by the letter “C”). The values of the temperatures associated with the cursors are found on the top left-hand side of the display.
3. Press the “Close” key to confirm your selection and go back to the general menu.

5.2.3 Emissivity menu

In this section it is possible to set the values of the **Emissivity** and **Reflected temperature** parameters which are necessary for possible corrections on the temperature measurement carried out by the instrument.

Parameter Emissivity

In order to carry out accurate temperature measurements, it is important to define the correct emissivity value (ϵ), which represents the ability of a body to emit infrared radiation, according to the kind of material the measured object is made of. Table 2 shows the emissivity values for the most common materials. Emissivity takes values between 0 (mirror or perfectly reflecting surface) and 1 (perfectly radiating blackbody). Most of the painted or oxydized surfaces have an emissivity value of approximately 0.95.

Material	Emissivity
Water	0.96
Stainless steel	0.14
Aluminium foil	0.09
Asphalt	0.96
Cement	0.97
Cast iron	0.81
Rubber	0.95
Wood	0.85
Bricks	0.75
Tape	0.96
Brass foil	0.06
Human skin	0.98
PVC plastic	0.93
Polycarbonate	0.80
Oxydized Copper	0.78
Rust	0.80
Paint	0.90
Earth	0.93

Table 2: Emissivity values of typical materials

Parameter Reflected temperature

Objects with a low emissivity may reflect infrared energy coming from adjacent objects; this energy is added to the energy of the object itself, thus causing possible measurement mistakes. In several situations, there are sources of heat with a higher temperature than the temperature found near the object being measured. In this case, it is necessary to compensate this reflected energy by entering the presumed temperature value of the adjacent heat source into the thermal camera. In most of the applications, the reflected temperature is identical to the environmental temperature and has negligible effects on temperature measurement on objects with a high emissivity.

Emissivity setting

1. Select the item “Emiss” with the keys \oplus or \ominus and press the key \blacksquare . The screen Fig. 17 – Central part is shown on the display.

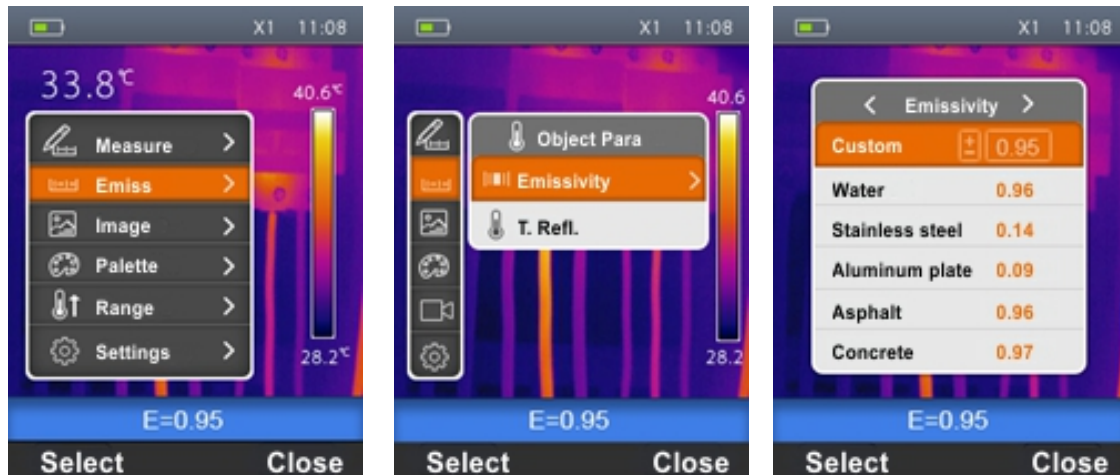

Fig. 17: Setting Emissivity on the instrument

2. Use the keys \oplus or \ominus to select the item “Emissivity” and press the key \blacksquare . The screen Fig. 17 – Right side is shown on the display
3. Use the keys \oplus or \ominus to select the emissivity values of materials found in the integrated table and press the key “Select” to confirm your choice.
4. Select the item “Custom” and confirm your custom setting of the emissivity value with the “Select” key. Use the keys \blacksquare or \triangle to set the value in the range: **0.01 ÷ 1.00**
5. Press the “Close” key to confirm your setting and to go back to the initial screen. The set emissivity value is displayed in the status bar.

Reflected temperature setting

1. Select the item “T. Refl.” using the keys \oplus or \ominus and press the key “Select”. The screen Fig. 18 – Central part is shown on the display

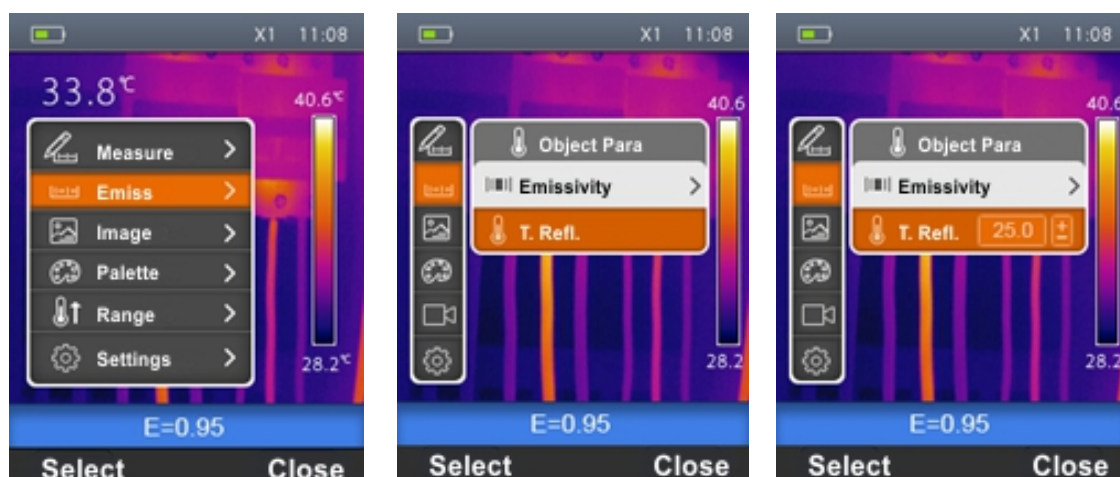

Fig. 18: Setting the Reflected Temperature on the instrument

2. Press the “Select” key to activate the setting of the reflected temperature value. Use the keys \oplus or \ominus to set the desired value of reflected temperature.
3. Press the “Close” key to exit and to go back to the previous screen

5.2.4 Image menu

In this section it is possible to select the display mode of IR and visual images.

1. Select the item "Image" using the keys or and press the key . The screen Fig. 19 – Right side is shown on the display

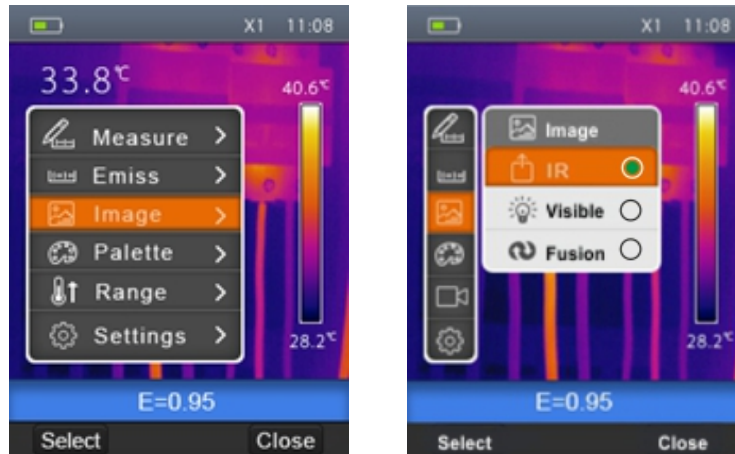

Fig. 19: Selecting the image display mode

2. Use the keys or to select the desired display mode among the options: **IR** (infrared image), **Visual** (visual image), **Fusion** (fusion of IR image into the visual one) (see Fig. 20)

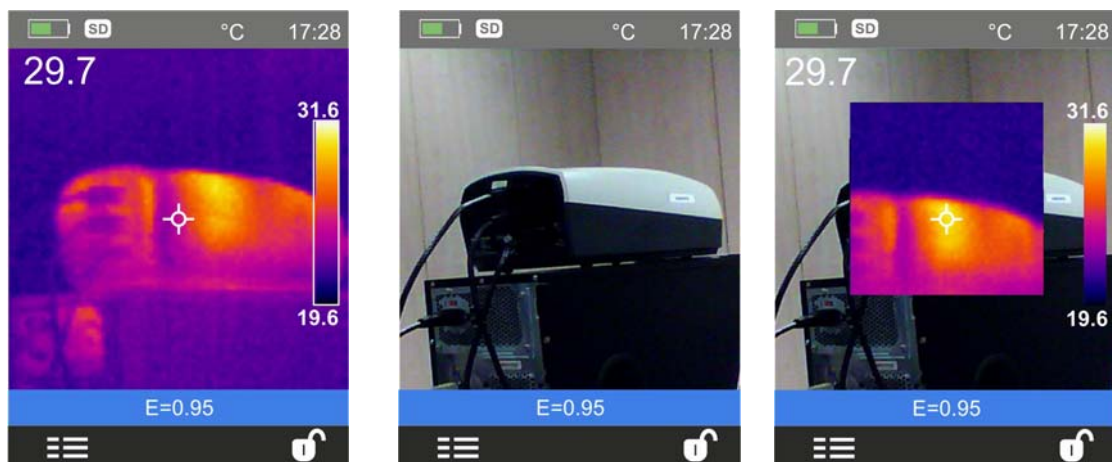

Fig. 20: Image display modes

3. With **Fusion** image selected, use the keys or to adjust the IR level inside the visible image
4. Press the "Select" key or the key to confirm the operation and go back to the previous screen of the "Close" key to exit without any modification.

5.2.5 Palette Menu

In this section it is possible to select the color palette which can be associated to the IR image.

1. Select the item “Palette” using the keys \oplus or \ominus and press the key $\left[\right]$. The screen Fig. 21 – Right side is shown on the display

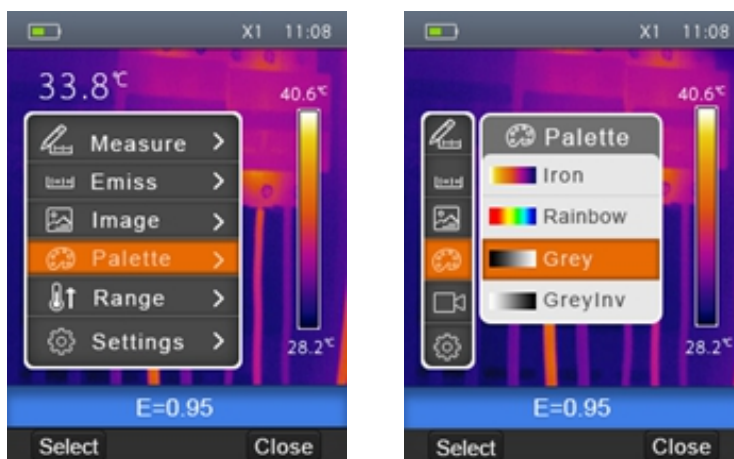

Fig. 21: Setting the colour palette

2. Use the keys \oplus or \ominus to select the desired colour palette among the options: **Iron**, **Rainbow**, **Grey** and **Grey Inv** watching the modification of selection on the display.
3. Press the “Select” key or the key $\left[\right]$ to confirm the operation and go back to the previous screen of the “Close” key to exit without any modification.

5.2.6 “Range” Menu

In this section it is possible to define the temperature measuring range of the instrument.

1. Select the item “Range” using the keys \oplus or \ominus and press the key $\left[\right]$. The screen Fig. 22 – Right side is shown on the display

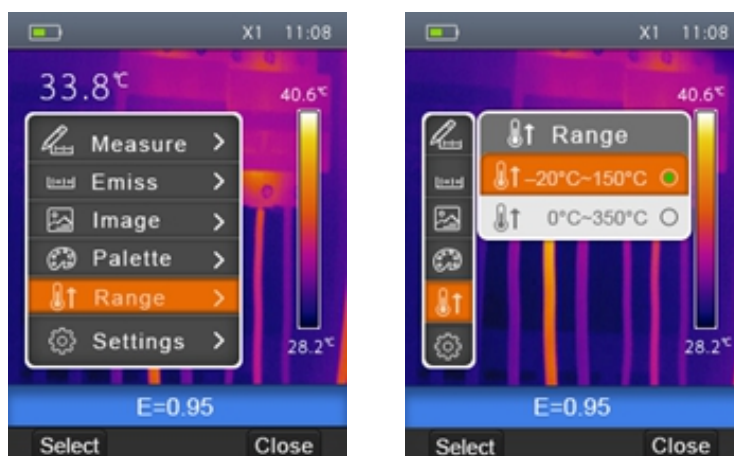

Fig. 22: Setting measuring range on the instrument

2. Use the keys \oplus or \ominus to select the measuring range among the options; **-20°C ÷ 150°C** or **0°C ÷ 350°C**.
3. Press the “Select” key or the key $\left[\right]$ to confirm the operation and go back to the previous screen of the “Close” key to exit without any modification.

5.2.7 Image adjustment

In this section it is possible to define the adjusting mode of the temperature associated with the image framed on the display. The following modes are available:

- **Auto** → (default)
- **Manual** →

To set Manual mode, proceed as follows:

1. Press the right key and set the symbol on the display.
2. Press and hold the key for 2 seconds. The following screen (see Fig. 23 – Left side) is shown on the display.

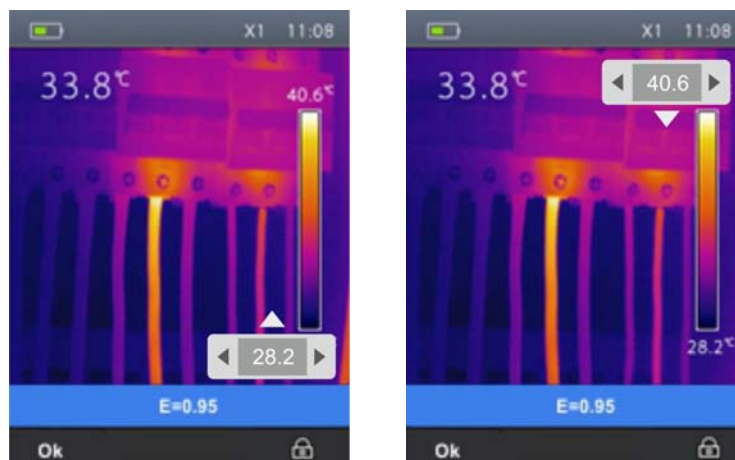

Fig. 23: Setting the adjustment mode of image temperature

2. Use the keys and to set the desired value of the temperature associated to the minimum level. Press and hold the keys for a quick setting of the value.
3. Press the key to go to the upper level of the color palette (see Fig. 23 – Right side).
4. Use the keys and to set the desired value of the temperature associated to the maximum level. Press and hold the keys for a quick setting of the value.
5. Press the “Ok” key to confirm. The values of the set levels are maintained by the instrument until a new modification is performed.
6. Press the right key to go back to Auto mode.

CAUTION



- **Automatic (Auto)** mode → the minimum and maximum temperature levels of the framed object on the display and associated with the colour palette are automatically defined by the instrument and dynamically vary when moving it. This (default) option, which can be used in most cases, allows for an optimum display of the IR image in a condition of temperatures equally distributed within it.
- **Manual** mode → the minimum and maximum temperature level of the object framed on the display are manually set by the user. This mode, particularly useful to clearly identify only some areas of the image, is recommended in case of advanced thermographic operations.

5.3 SAVING THE IMAGE ON THE DISPLAY

1. Insert the micro SD card into the relevant slot of the instrument (see Fig. 4). The icon “SD” is shown in the top left-hand part of the display.
2. Select the desired image display mode (see § 5.2.4).
3. Press the **T** (Trigger) key to freeze the image shown on the display (see Fig. 24).
4. Press the “Save” key to definitively save the image. The message “Save YYYYMMDD _xxxx.jpg” appears for a moment on the display (“YYYYMMDD” indicates the year, month and day in which the image was saved while “xxxx” indicates the sequence number of the image saved).

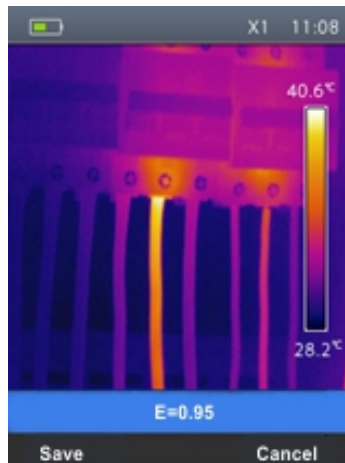

Fig. 24: Saving the image on the display

5. Press the “Cancel” key to exit without saving.

5.4 RECORDING A VIDEO ON THE DISPLAY

1. Insert the micro SD card into the relevant slot of the instrument (see Fig. 4). The icon “SD” is shown in the top left-hand part of the display.
2. If necessary, insert the jack of the headphones into the camera (see Fig. 2 – Part 17).
3. Select the desired image display mode (see § 5.2.4).
4. Press and hold the **T** (Trigger) key for some seconds to activate video recording. The message “YYYYMMDD _xxxx.mp4” appears in the status bar and the timer appears at the bottom of the display (see Fig. 25)

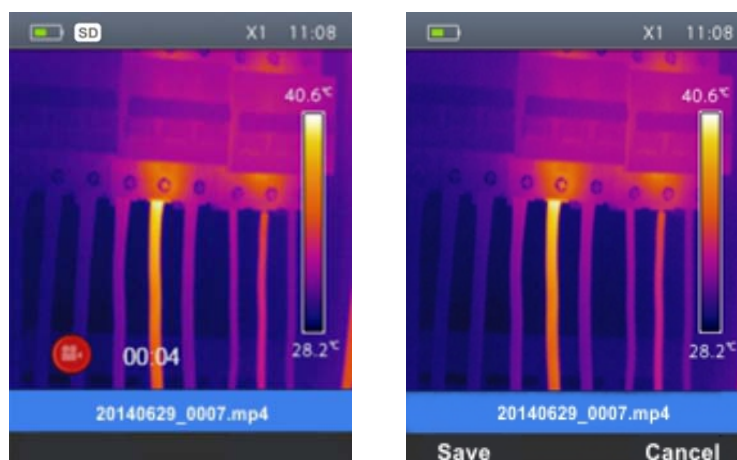

Fig. 25: Video recording

5. Talk into the microphone as long as you desire.
6. Press the **T** (Trigger) key again to stop the video
7. Press the “Save” key to save the video or the “Cancel” key to exit without saving.

5.5 RECALLING AND DELETING DISPLAYED IMAGES AND VIDEOS

The instrument allows recalling and watching on the display every image/video saved on the micro SD card.

1. Press the key . The instrument displays the last saved image/video (see Fig. 26 – Left side).

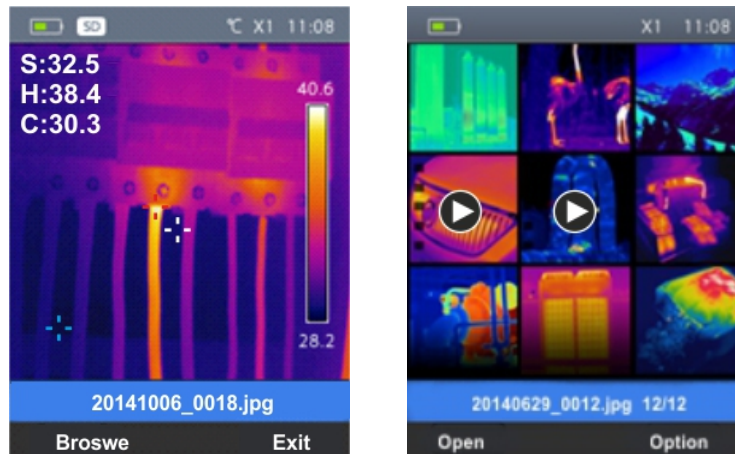

Fig. 26: Recalling an image or video on the display

2. Use the keys or to scroll the images/videos in the gallery on the display.
3. Press the key “Browse” to access the gallery of saved images/videos (see Fig. 26 – Left side).
4. Press the key “Open” to recall the selected image/video on the display.
5. Press the “Option” key. The following screen appears on the instrument's display:

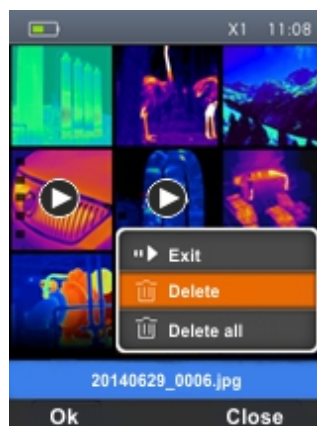



Fig. 27: Deleting an image or video on the display

6. Select the option “Delete” and press the “Ok” key to delete the selected image/video.
7. Select the option “Delete all” and press the “Ok” key to delete the entire content of the micro SD card.
8. Select the option “Exit” and press the “Ok” key to exit the gallery and go back to the main screen. Press the “Close” key to close the submenu.

5.5.1 Playback of videos on the display

To play a video saved on the instrument's micro SD card, proceed as follows:

1. Press the key  and recall the video on the display (see Fig. 28 – Left side).
2. If necessary, insert the jack of the headphones into the instrument (see Fig. 2 – Part 17).
3. Adjust the level of sound volume (see § 5.2.1).
4. Press the **T** (Trigger) key to activate video playback. A cursor and progress bar are shown on the display (see Fig. 28 – Right side).

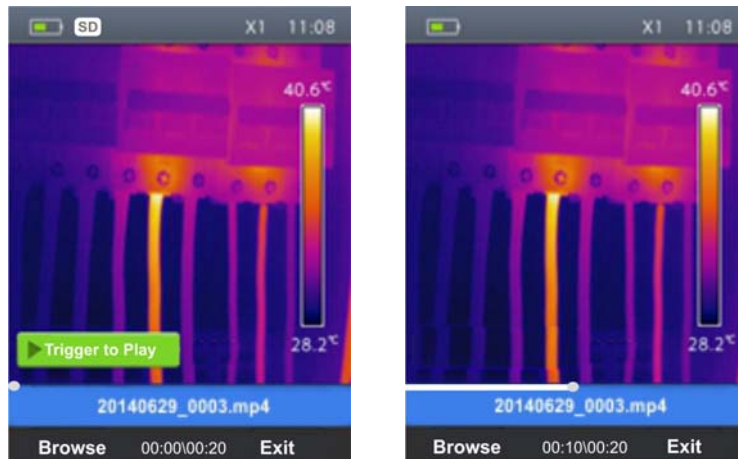



Fig. 28: Playback of videos on the display

5. Press the **T** (Trigger) key again to pause playback.
6. Press the "Browse" key to go back to the gallery of images/videos or "Exit" key to back to the main menu

5.6 USING THE INSTRUMENT

For a typical use of the instrument, please refer to the following procedure:

1. Switch on the instrument by pressing the “” key. After approx. 20 seconds of internal autotest, the instrument shows its normal measuring screen. Upon start-up, the instrument shows a screen like the one shown in Fig. 29.

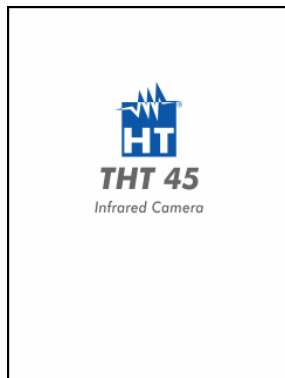

Fig. 29: Initial screen

2. It takes approx. 30 seconds for the instrument to become fully operating. During this time interval, the instrument carries out an automatic calibration and the internal commutations may produce some noise.

CAUTION



The autocalibration sequence starts when the instrument is switched on and continues during the thermal cameras normal operation, during which the image freezes for a few seconds in order to eliminate offset errors. The noise produced by the commutation of internal parts is not to be considered as a problem of the instrument.

3. Before any measuring operation, correctly focus the thermal camera in order to prevent having grossly inaccurate measurements and a low quality of the saved image (see § 5.1.1).
4. For accurate temperature measurements, make sure the surface of the measured object is always bigger than the surface measurable by the instrument, which is given by the instruments field of view (FOV). The instrument THT45 has a field of view of 17° x 17° and a detection vector of 80x80 (6400) pxl (see Fig. 30).

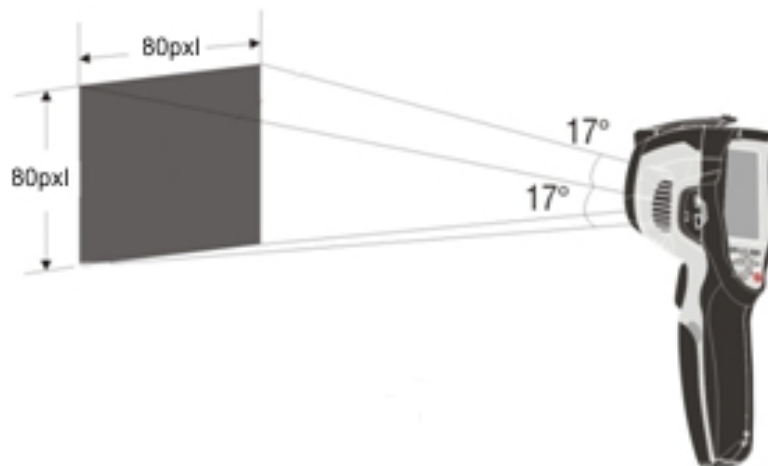

Fig. 30: Representation of the instruments field of view (FOV) for THT45

The representation of the ratio D (distance from the object) / S (surface of the object) for an instrument THT45 provided with 9mm lens is described below.

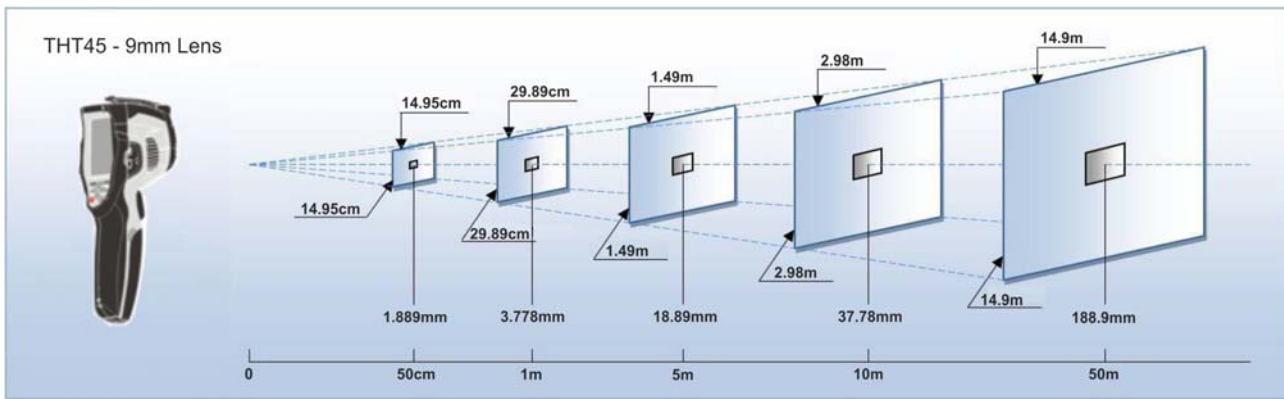



Fig. 31: Representation of the THT45 instrument's D/S ratio

In the representation, it is possible to see how the IFOV (Instant Field Of View = geometrical resolution of the instrument = size of the single pxl of the IR sensor) is equal to 3.78mm at a distance of 1m of the instrument from the object being measured. This means that the instrument is capable of carrying out correct temperature measurements at a distance of 1m on objects with a size not lower than 3.78mm.

5. The typical application of thermal cameras is the one in which it is necessary to detect a temperature difference between two adjacent objects, as this kind of analysis is often sufficient to identify anomalies in electrical and mechanical appliances, etc. In such situations, in which an accurate temperature measurement is not strictly necessary, emissivity value may be set to "1" (see § 5.2.3), it is not necessary to consider the objects surface, its distance and the field of view). However, if accurate measures are required (e.g. the temperature of an electric motor), it is necessary to correctly set the parameters previously described in this manual.
6. Correctly set the temperature range of the image (see § 5.2.1), defining the adequate values according to the MIN and MAX temperatures detected within the measured area.
7. Frame the objects to be measured by using the laser pointer, if necessary (see § 4.2.4). The instrument displays the temperature values associated with the measuring cursors.
8. Use the **T** (Trigger) key to freeze the image on the display and save it on the external micro SD card. The instrument saves the images in sequence with file name "YYYYMMDD_xxxx.jpg".
9. Press the key  to see the saved images again (see § 5.5).

5.7 TRANSFERRING IMAGES/VIDEOS ONTO THE PC

The instrument allows saving the images/videos on an external micro SD card and to transfer them onto the PC by using the USB cable. Both the micro SD card and the cable are provided with the instrument. Proceed as follows:

1. Insert the micro SD card into the dedicated slot inside the battery compartment (see Fig. 4 – Part 3 and 4).
2. Connect the USB cable to the instrument (see Fig. 2 – Part 19) and to the PC. The following screen (see Fig. 32 – Left side) is shown on the display:

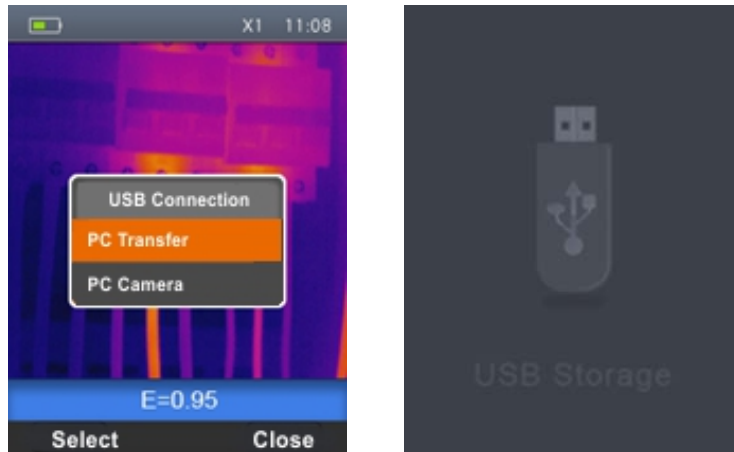

Fig. 32: Transferring images/videos onto the PC

4. Use the keys \oplus or \ominus to select the option “PC Transfer” and press the “Select” key. The screen Fig. 32 – Right side is shown on the display.
5. Inside “**My Computer**”, search for the removable disk associated to the micro SD card and copy the files “YYYYMMDD_xxxx.jpg” of the desired images or the files “YYYYMMDD_xxxx.mp4” of the desired videos contained in two separate folders on the micro SD card to a PC folder.
6. Disconnect the USB cable to go back to the instrument’s main screen.

5.7.1 Displaying an image on the PC in real time

The instrument allows displaying on the PC in real time the image shown on the display. To carry out this operation, proceed as follows:

1. Connect the USB cable to the instrument (see Fig. 2 – Part 19) and to the PC. The following screen (see Fig. 33 – Left side) is shown on the display:

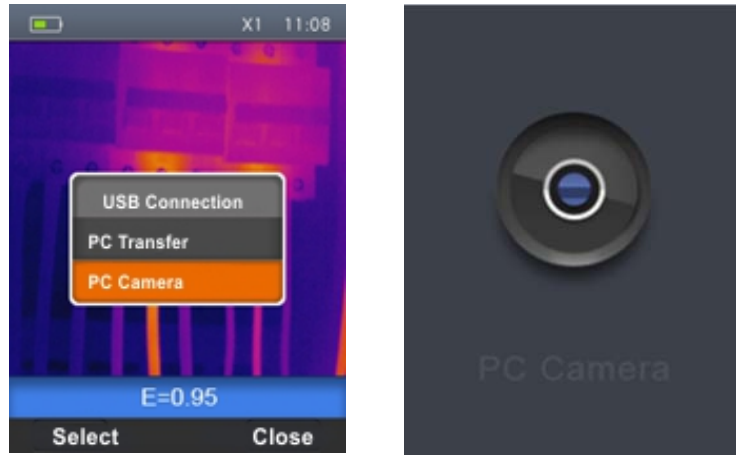

Fig. 33: Displaying an image on the PC in real time

2. Use the keys \oplus or \ominus to select the option “PC Camera” and press the “Select” key. The screen Fig. 33 – Right side is shown on the display.
3. Inside “**My Computer**”, search for the “USB video device” which is automatically recognized by the PC and allows displaying the (IR or visual) image on the instrument’s display in real time.
4. Disconnect the USB cable to go back to the instrument’s main screen.

5.8 HDMI VIDEO OUTPUT

The video output available in the instrument (see Fig. 2 – Part 18) enables displaying the IR image acquired on an external monitor/device capable of managing HDMI systems. To connect the instrument, proceed as follows:

1. Switch on the instrument.
2. Connect the instrument to the external monitor/device using the HDMI video cable provided.
3. Turn on the external monitor or device.
4. Check for the presence of the IR image both on the instrument's display and on the monitor or external device with contemporary management of the operations.
5. Detect/monitor the image on the external monitor or device.
6. At the end of the operations, switch off the monitor or external device and disconnect the HDMI video cable from the instrument.

6 USING THE THTLINK SOFTWARE

The software “THTLink” can be used to analyse the images saved on the micro SD card inserted in the instrument.

6.1 MINIMUM SYSTEM REQUIREMENTS

Hardware:	Pentium IV
RAM memory:	512MB
Output interface:	USB ports or SD card reader
CD-ROM reader:	present
Screen resolution:	800x600
Operating system:	Windows XP o higher
Software applications:	Microsoft .Net Framework 2.0 or higher

6.2 INSTALLING THE THTLINK SOFTWARE

1. Insert the installation CD-ROM into the reader of the PC.
2. Launch the file “**THTLink.exe**” found inside the CD-ROM and follow the guided installation procedure

6.3 MAIN CHARACTERISTICS OF THE THTLINK SOFTWARE

With launched program, the PC shows the following initial screen:

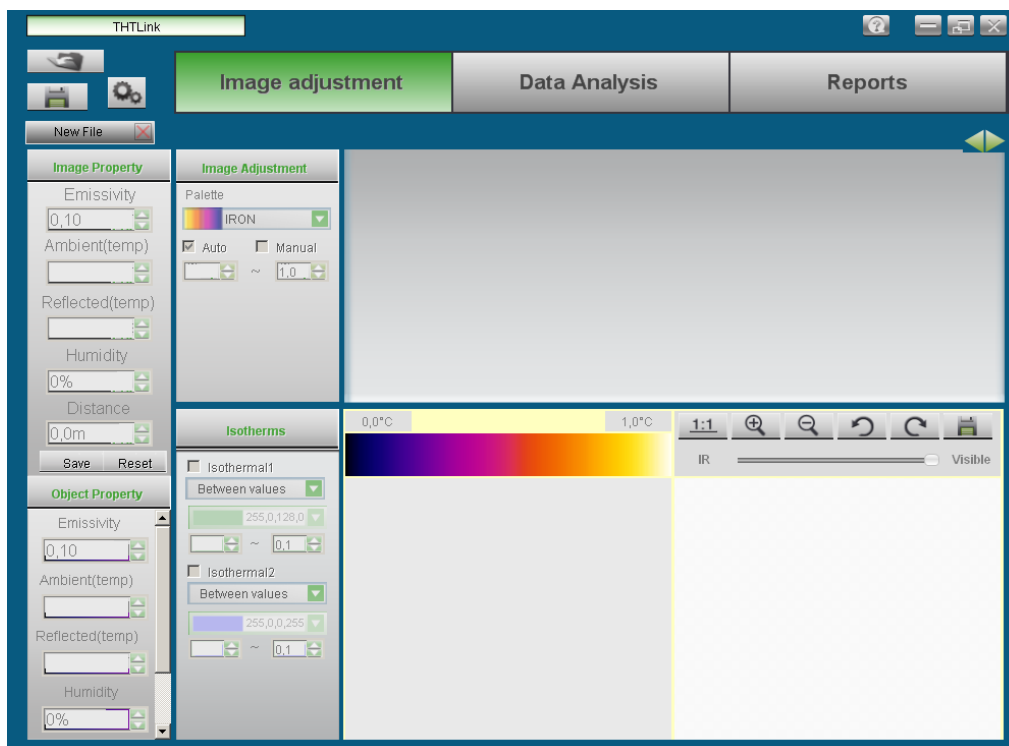

Fig. 34: Starting screen of the THTLink software

Main characteristics of the THTLink software:

- Display of IR and visual images
- Insertion of advanced analysis tools (points, lines, areas, isotherm lines)
- Realization of graphs from IR images
- Realization of print reports in RTF and PDF format
- Playback of the voice annotations saved on the images

For information about the use of THTLink, please refer to the Help on line of the software itself

7 MAINTENANCE

7.1 GENERAL INFORMATION

1. The instrument you purchased is a precision instrument. While using and storing the instrument, carefully observe the recommendations listed in this manual in order to prevent possible damage or danger during use.
2. Do not use the instrument in environments with high humidity levels or high temperatures. Do not expose to direct sunlight.
3. Always switch off the instrument after use. In case the instrument is not to be used for a long time, remove the battery to avoid liquid leaks that could damage the instrument's internal circuits.





7.2 RECHARGING THE INTERNAL BATTERY

The instrument is designed to be supplied with a Li-ION rechargeable battery. With the symbol "", it is necessary to recharge the battery.

CAUTION



- The battery must not be removed from the instrument while recharging.
- Recharge the battery at environmental temperature and, anyway, in a range between **0°C** and **50°C** (32°F and 122°F).
- When using the instrument for the first time, recharge the battery for at least **6 hours**.

1. Connect the battery charger provided with the instrument to the AC electric mains and the mini USB output to the instrument's input (see Fig. 3 – Part 16). Check that the green LED of battery charge (see Fig. 3 – Part 15) has turned on with steady light.
2. With the instrument turned on, the indicator of the battery charge level takes the symbols "" "→" "" "→" "" "→" "" in a sequence. When the symbol "" appears on the display and the battery charger has been disconnected from the instrument, the charging process is complete.
3. With the instrument turned off, the charging process is complete when the green LED of battery charge turns off.
4. Disconnect the battery charger from the instrument and from the electric mains.

7.3 CLEANING THE INSTRUMENT

Use a soft and dry cloth to clean the instrument. Never use wet cloths, solvents, water, etc.

7.4 END OF LIFE



CAUTION: this symbol found on the instrument indicates that the appliance, its accessories and the batteries must be collected separately and correctly disposed of.

7.5 ACCESSORIES

7.5.1 Accessories provided

- Integrated 9mm focal lens
- Rechargeable Li-ION battery, 3.7V 2000mAh
- AC/DC 100-240V/5V adapter + universal plugs
- Micro SD card, 8GB
- USB cable
- USB OTG cable (THT46)
- HDMI video cable
- Set of headphones for intercom
- Non-slip strap
- CD-ROM with Windows software THTLink
- ISO9000 calibration certificate
- Quick user guide
- User manual on CD-ROM
- Soft transport bag

8 TECHNICAL SPECIFICATIONS

Range	Sensitivity	Accuracy (*)	Resolution	Image frequency
-20°C ÷ 350°C	<0.1°C@30°C	±2%reading or ±2°C	80x80pxl (THT45) 160x120pxl (THT46)	50Hz

(*) Accuracy referred to environmental temperature within 10°C and 35°C and object temperature >0°C

General specifications

Type of IR sensor	UFPA (80x80pxl, 34µm – TH45) UFPA (160x120pxl, 25µm – TH46)
Spectrum response:	8 ÷ 14µm
Visual range (FOV) / Lens:	17° x 17° (THT45), 25° x 19° (THT46) / 9mm
IFOV (@ 1m):	3.78mrad (THT45), 2.78mrad (THT46)
Focusing:	manual
Minimum focus distance:	0.5m
Temperature readings:	°C, °F, °K
Available colour palettes:	4 (Iron, Rainbow, Grey, Grey Inverse)
Laser pointer:	class 2 according to IEC 60825-1
Built-in illuminator:	white LED light
Electronic zoom:	x1, x32
Emissivity correction:	0.01 ÷ 1.00 in steps of 0.01
Image adjustment mode:	Automatic / Manual
Measuring functions:	corrections with emissivity and reflected temperature
Measuring cursors:	3 (Fixed, Max Temp., Min Temp.)
Inbuilt photo camera:	1.3Mpxl, FOV 59°
PiP fusion function:	IR in Visual
Video output:	HDMI
IR video recording:	on micro SD card (MPEG4, 1280x960@30fps)
Memory:	micro SD card 8GB (>2000 JPG images)
PC interface:	USB 2.0
Audio output:	Yes
Power supply	
Internal supply:	rechargeable Li-ION battery, 3.7V 2600mAh
External supply:	adapter 100-240VAC (50/60Hz)/5VDC
Battery duration:	4 hours of continuous use

Display

Characteristics: Colour, LCD 2.8", 320x240pxl

Mechanical characteristics

Size (L x W x H): 224 x 77 x 96mm (9 x 3 x 4in)

Weight (battery included): 0.5kg (10lv)

8.1 ENVIRONMENT

8.1.1 Environmental conditions for use

Operating temperature: -15°C ÷ 50°C (5°F ÷ 122°F)

Storage temperature: -40°C ÷ 70°C (-40°F ÷ 158°F)

Allowable relative humidity: 10 ÷ 90%RH

Encapsulation: IP50 according to IEC529

Fall test: 2m

Shock: 25G in compliance with IEC60068-2-29

Vibrations: 2G in compliance with IEC60068-2-6

**This instrument complies with Directive EMC 2004/108/EC
This instrument complies the requirements of 2011/65/CE (RoHS) directive and 2012/19/CE
(WEEE) directive**

9 SERVICE

9.1 WARRANTY CONDITIONS

This instrument is warranted against any material or manufacturing defect, in compliance with the general sales conditions. During the warranty period, defective parts may be replaced. However, the manufacturer reserves the right to repair or replace the product.

Should the instrument be returned to the After-sales Service or to a Dealer, transport will be at the Customer's charge. However, shipment will be agreed in advance.

A report will always be enclosed to a shipment, stating the reasons for the product's return. Only use original packaging for shipment; any damage due to the use of non-original packaging material will be charged to the Customer.

The manufacturer declines any responsibility for injury to people or damage to property.

The warranty shall not apply in the following cases:

- Repair and/or replacement of accessories and battery (not covered by warranty).
- Repairs that may become necessary as a consequence of an incorrect use of the instrument or due to its use together with non-compatible appliances.
- Repairs that may become necessary as a consequence of improper packaging.
- Repairs which may become necessary as a consequence of interventions performed by unauthorized personnel.
- Modifications to the instrument performed without the manufacturer's explicit authorization.
- Use not provided for in the instruments specifications or in the instruction manual.

The content of this manual cannot be reproduced in any form without the manufacturer's authorization.

Our products are patented and our trademarks are registered. The manufacturer reserves the right to make changes in the specifications and prices if this is due to improvements in technology.

9.2 SERVICE

If the instrument does not operate properly, before contacting the After-sales Service, please check the conditions of the batteries and replace them, if necessary. Should the instrument still operate improperly, check that the product is operated according to the instructions given in this manual.

Should the instrument be returned to the After-sales Service or to a Dealer, transport will be at the Customer's charge. However, shipment will be agreed in advance. A report will always be enclosed to a shipment, stating the reasons for the product's return. Only use original packaging for shipment. Any damage due to the use of non-original packaging material will be charged to the Customer.